

200H MODULE

- NOTES**
 ALL RESISTORS 1/4W UNLESS NOTED
 ALL CAPACITORS IN MFD UNLESS NOTED
 ALL DIODES 4-148 UNLESS NOTED
 LAST REF. DESIGNATOR USED:
 R31 C24 CR19 Q1
 * CONNECTED TO HEATSINK

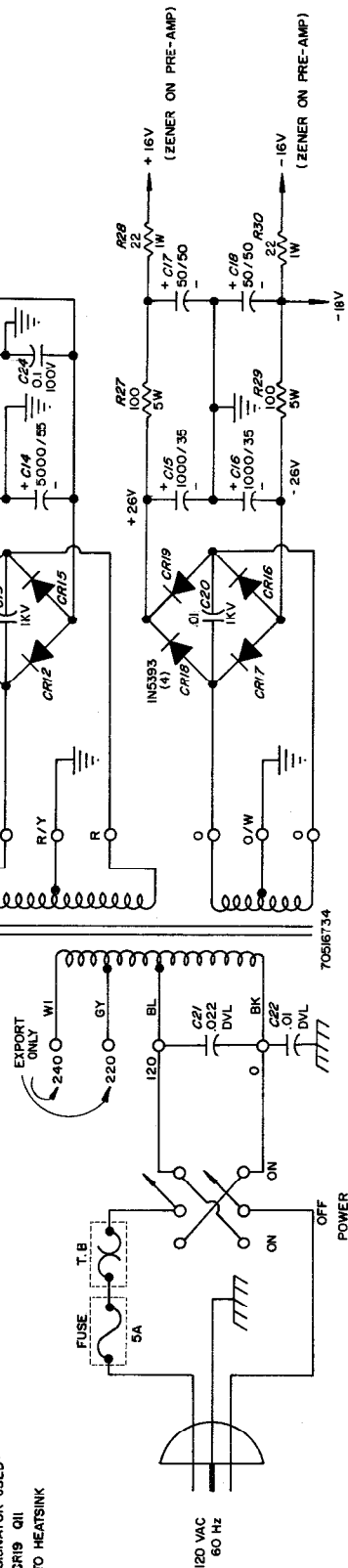

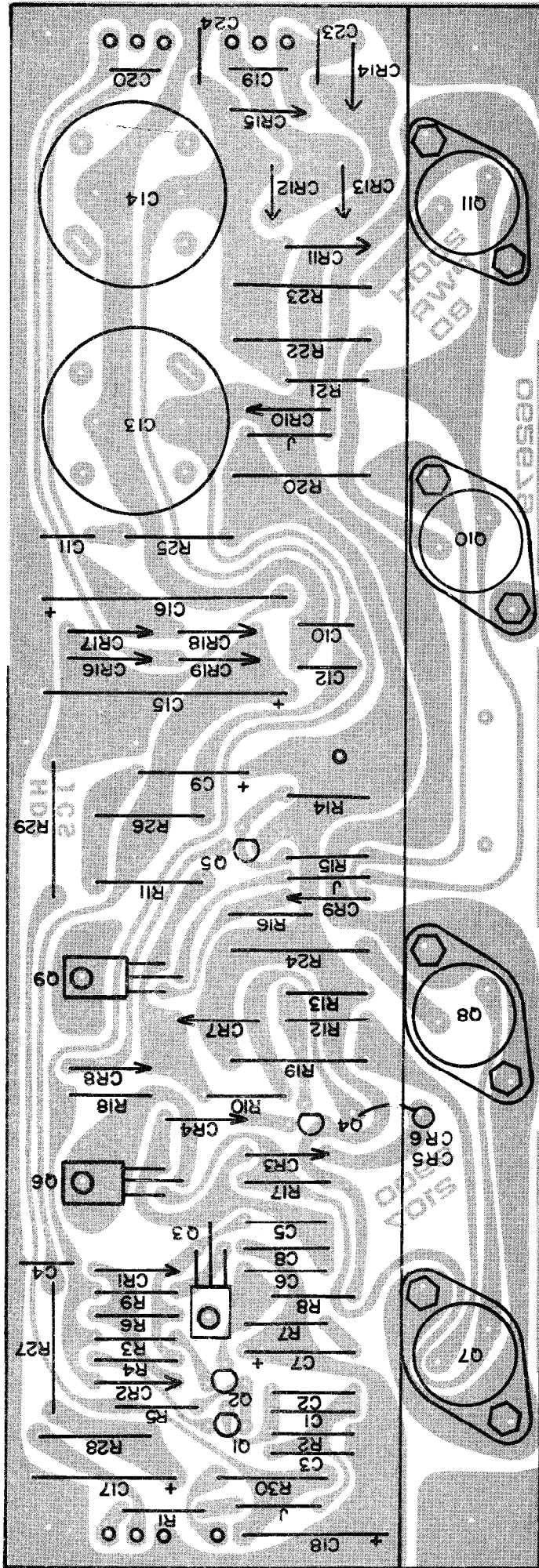

200 H MODULE