



# ***SERVICE MANUAL***

## ***YCV40***

**WEB ACCESS:** <http://www.yorkville.com>

### **WORLD HEADQUARTERS CANADA**

**Yorkville Sound**  
550 Granite Court  
Pickering, Ontario  
L1W-3Y8 CANADA

Voice: (905) 837-8481  
Fax: (905) 837-8746

### **U.S.A.**

**Yorkville Sound Inc.**  
4625 Witmer Industrial Estate  
Niagara Falls, New York  
14305 USA

Voice: (716) 297-2920  
Fax: (716) 297-3689



**Quality and Innovation Since 1963**  
Printed in Canada



Manual-Service-YCV40-1v2.pdf





# YCV40

Traynor Guitar Series

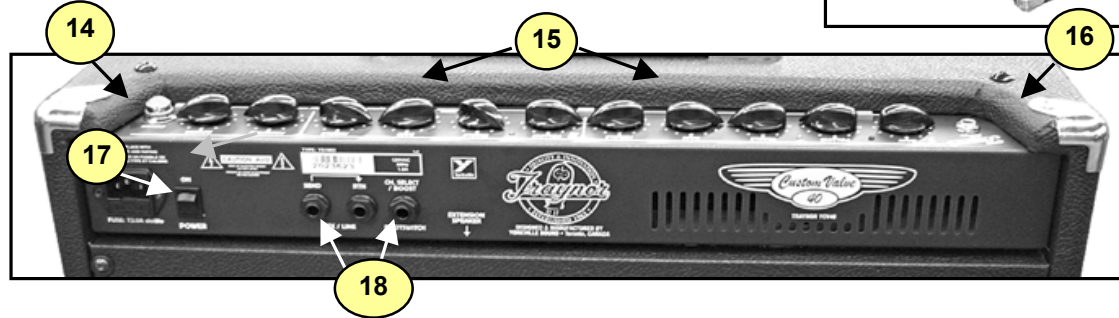
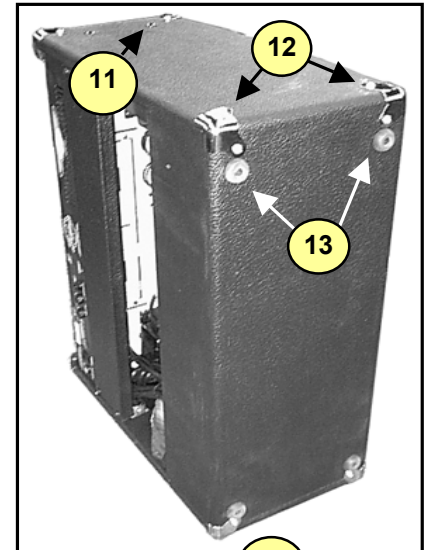
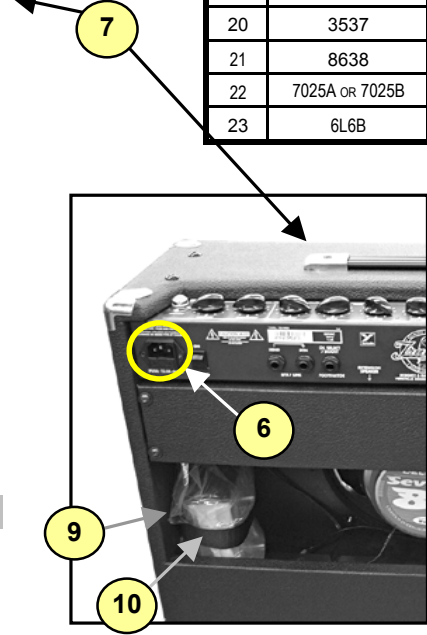
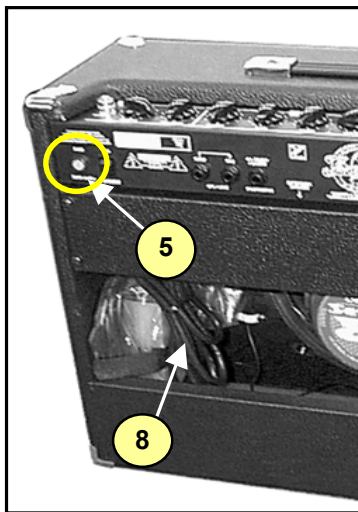
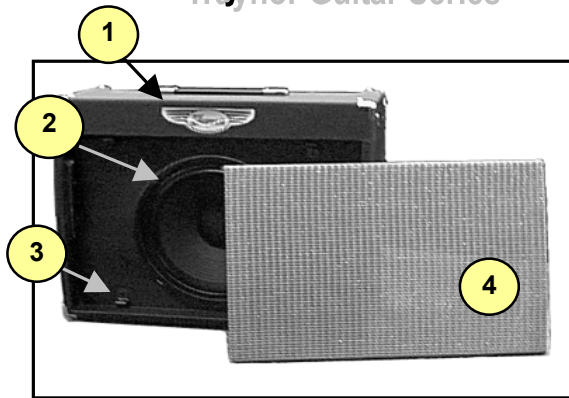

- 19/20 REVERB CABLE AND UNIT
- 21 PUSH BUTTON CAPS
- 22/23 TUBES

#	Part#	Description
<b>Labeled Components</b>		
1	8260	TRAYNOR LOGO
2	7080	12" 8R 80WPGM SPEAKER CELESTION
3	8461	TRIM CLIP (PLATED BLK ZINC)
4	Z357	YCV40 GRILLE*
5	3482	LOWPROFILE FUSEHOLDER 1/4" BUSSMANN
6	3438	AC RECEPTACLE / FUSE HOLDER
7	8456	10.0" STRAP HANDLE, NICKEL COVERS
8	3426	AC LINE CORD - #3474(EURO)
9	TFS-2B	TRAYNOR DUAL FOOTSWCH 10' CORD
10	3552	NYLON SPRING CLAMP
11	8770	1/4-20 X 1 5/16 TRUSS PH MS JS5
12	8504	CORNER, 2 LEGS NOTCED LIP NICKEL PLATED
13	8543	RECESSED RUBBER BUMPER WITH WASHER
14	6397	JEWELLED PILOT LAMP AMBER REG
15	8430	CHICKEN-BEAK KNOB
16	3921	1/4" JCK PCB MT VERT STER RT SWT
17	3698	SPST ROKR SW QUIK 180° AC PWR
18	3450 & 3450NUT	1/4" ALL GOLD PC MNT JK SKT
19	3886 & 3890	36" PREFAB. CABLE (RED/BLACK)
20	3537	ACC# 4EB3C1B LONG REVERB
21	8638	PUSH SW BUTTON GREY
22	7025A OR 7025B	12AX7 DUAL TRIODE PREAMP TUBE
23	6L6B	6L6GB OUTPUT POWER TUBE

\*NOTE: Replacement grilles are 'Special-Order' and are only available while the model is in production.

**Real Gear.  
Real People.**

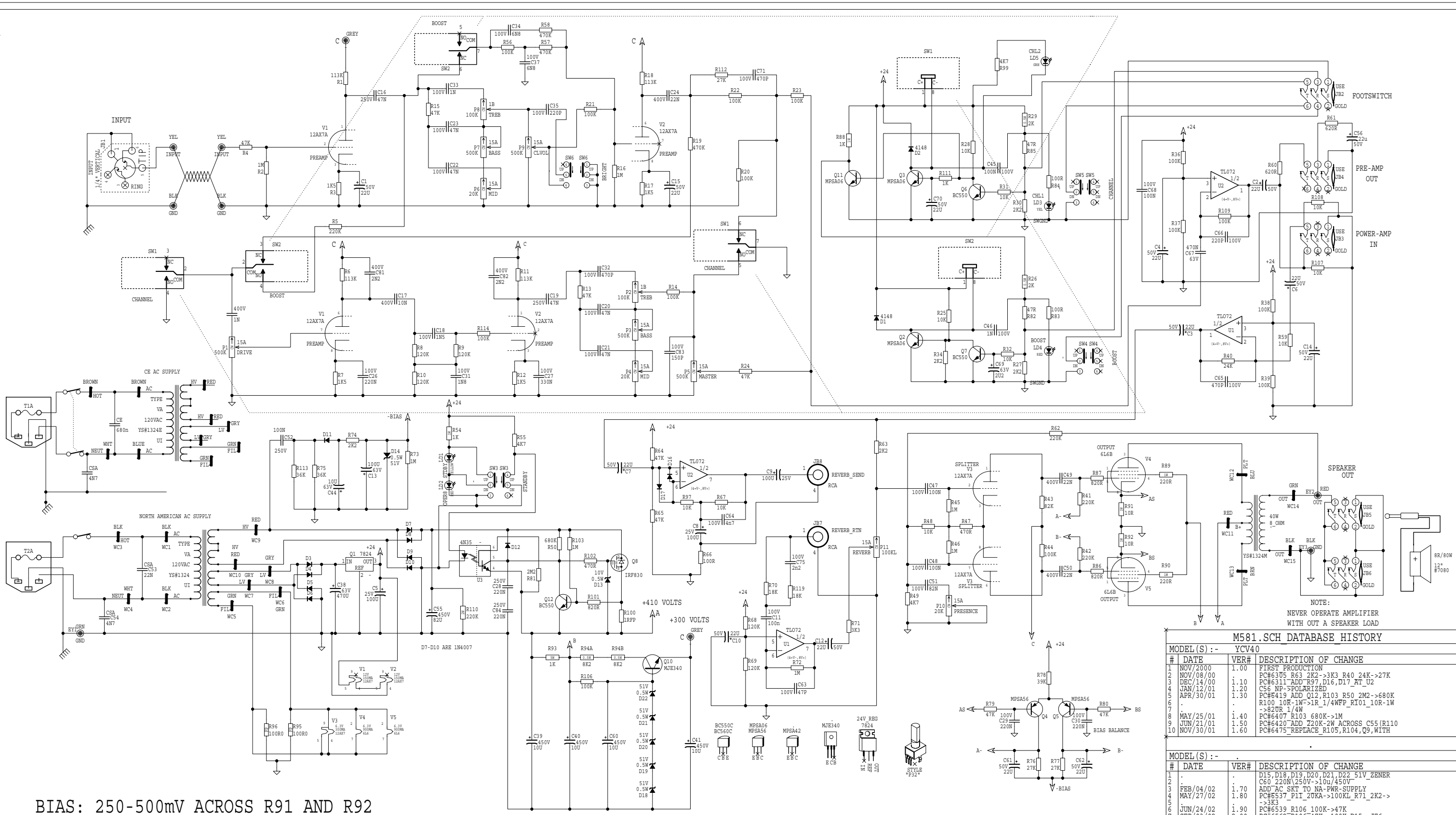

BIAS: 250-500mV ACROSS R91 AND R92

M581.SCH DATABASE HISTORY			
#	DATE	VER#	DESCRIPTION OF CHANGE
1	NOV/2000	1.00	FIRST PRODUCTION
2	NOV/08/00	1.10	PC#6305 R63 2K2->3K3 R40 24K->27K
3	DEC/14/00	1.20	PC#6311-ADD R97, D16, D17, RT U2
4	JAN/12/01	1.20	C56 NP->POLARIZED
5	APR/30/01	1.30	PC#6419 ADD Q12, R103 R50 2M2->680K
6			R100 10K-1W->1R 1/4WFP_R101_10R-1W
7			->820R 1/4W
8	MAY/25/01	1.40	PC#6407 R103 680K->1M
9	JUN/21/01	1.50	PC#6420 ADD 220K-2W ACROSS C55 (R110
10	NOV/30/01	1.60	PC#6475-REPLACE R105, R104, Q9, WITH

#	DATE	VER#	DESCRIPTION OF CHANGE
1			D15, D18, D19, D20, D21, D22 51V_ZENER
2			C60 220N(250V->10u/450V
3	FEB/04/02	1.70	ADD AC SKT TO NA-PWR-SUPPLY
4	MAY/27/02	1.80	PC#6537_P11_20KA->100KL_R71_2K2->
5			->3K3
6	JUN/24/02	1.90	PC#6539 R106 100K->47K
7	SEP/03/02	2.00	PC#6562_R106_47K->100K_D15->J76
8			N
9			N
10			N

M581.PCB DATABASE HISTORY

#	DATE	VER#	DESCRIPTION OF CHANGE
1	NOV/02/00	1.00	FIRST PRODUCTION
2	NOV/08/00	2.00	PC#6305 R63 2K2->3K3 R40 24K->27K
3	DEC/14/00	2.00	PC#6311 ADD D16, D17, R97 AT U2
4	FEB/23/01	2.10	PC#6326 HOLE SIZE FOR C53 070"->047
5	APR/30/01	3.00	PC#6419 ADD Q12, R103 R50 2M2->680K
6	.	.	R100 10R/1W->1R 1/4WFP R101 10R/1W
7	.	.	->820R 1/4W
8	MAY/25/01	4.00	PC#6407 R103 680K->1M
9	JUN/21/01	4.00	PC#6420 ADD 220K-2W ACROSS C55 (R110
10	NOV/30/01	5.00	PC#6475 R105, R104, Q9 REPLACED BY
11	.	.	D15, D18, D19, D20, D21, D22 6X51V
12	.	.	ZENER C60 220N/250V->10u/450V
13	JAN/15/02	6.00	NEW SOLDERMASK FOR TABS & RCA JACKS
14	MAY/03/02	6.10	ADD ROUTING BY OUTPUT TUBES
15	MAY/27/02	6.20	PC#6537 R71 2K2->3K3 P11 20KA->100K
16	JUN/24/02	6.30	PC#6539 R106 100K->47K
17	JUL/04/02	7.10	PC#6545 MOVE X57 AND C60
18	SEP/03/02	7.10	PC#6562 R106 47K->100K D15->J76
19	D	V	N
20	D	V	N

BIAS  
250-500 MV ACROSS R91 AND R92

M581.PCB POT LIST

MODEL(S) :- YCV40 TUBE AMP

REF	FUNCTION	PART#	KNOB	AS OF
P1	DRIVE	#4425	8430	11/00
P2	TREBLE	#4424	8430	11/00
P3	BASS	#4425	8430	11/00
P4	MID	#4423	8430	11/00
P5	MASTER	#4425	8430	11/00
P6	MID	#4423	8430	11/00
P7	BASS	#4425	8430	11/00
P8	TREBLE	#4424	8430	11/00
P9	CLEAN VOLUME	#4425	8430	11/00
P10	PRESENCE	#4423	8430	11/00
P11	REVERB	#4424	8430	05/02

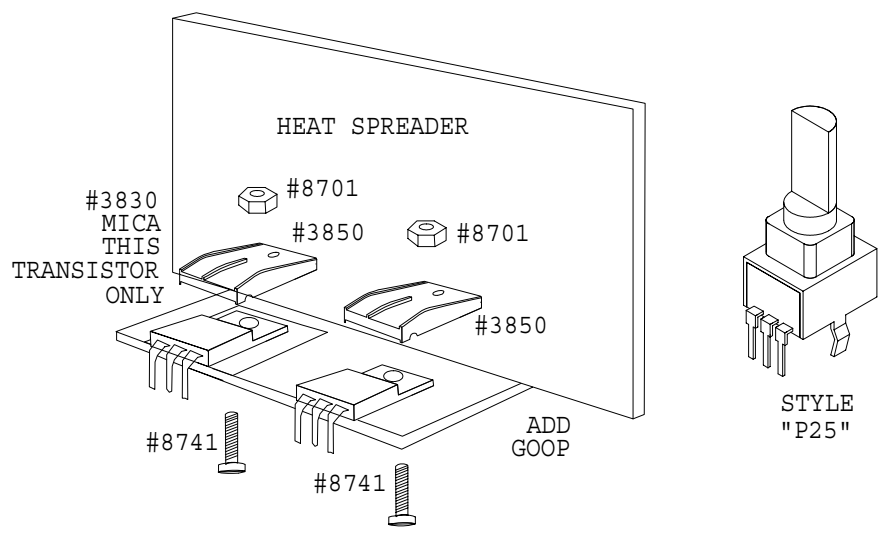

PRODUCTION NOTES

1 RTV MUST BE ADDED TO THE FOLLOWING CAPS  
C1, C16, C19, C17, C70, BETWEEN C84, C28 C60, C15  
BETWEEN C49, C50, ADDED TO C15, C7, C8, C3, C9  
C56, C14, C6, C10, C4, C2 AND C12

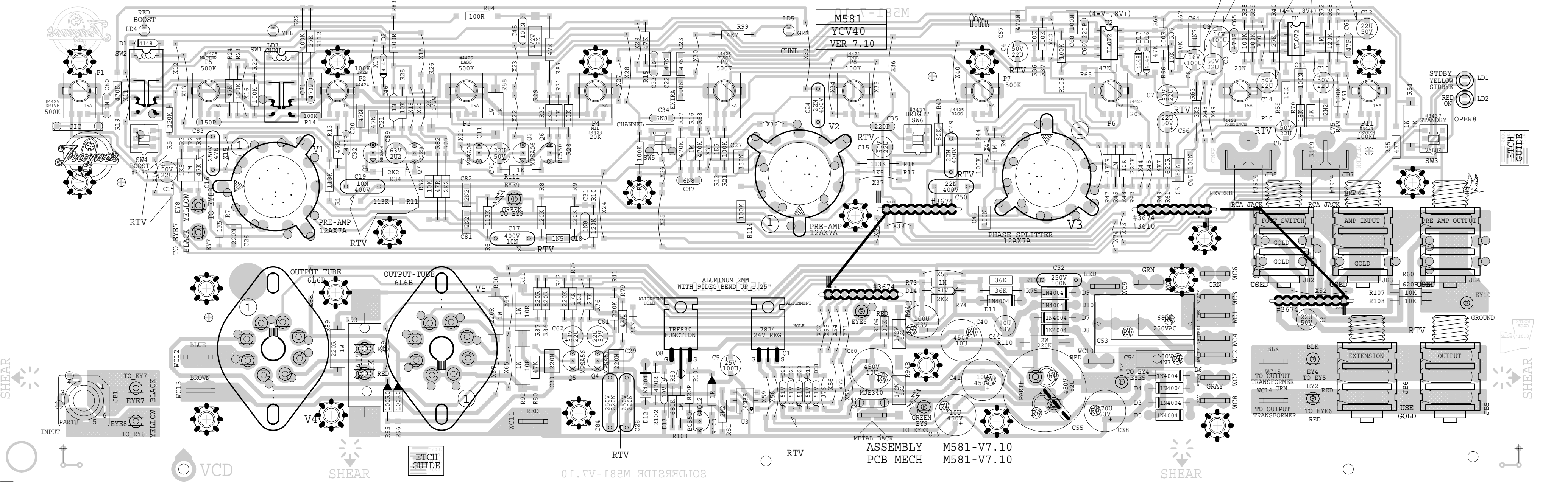

ASSEMBLY M581-V7.10  
PCB MECH M581-V7.10

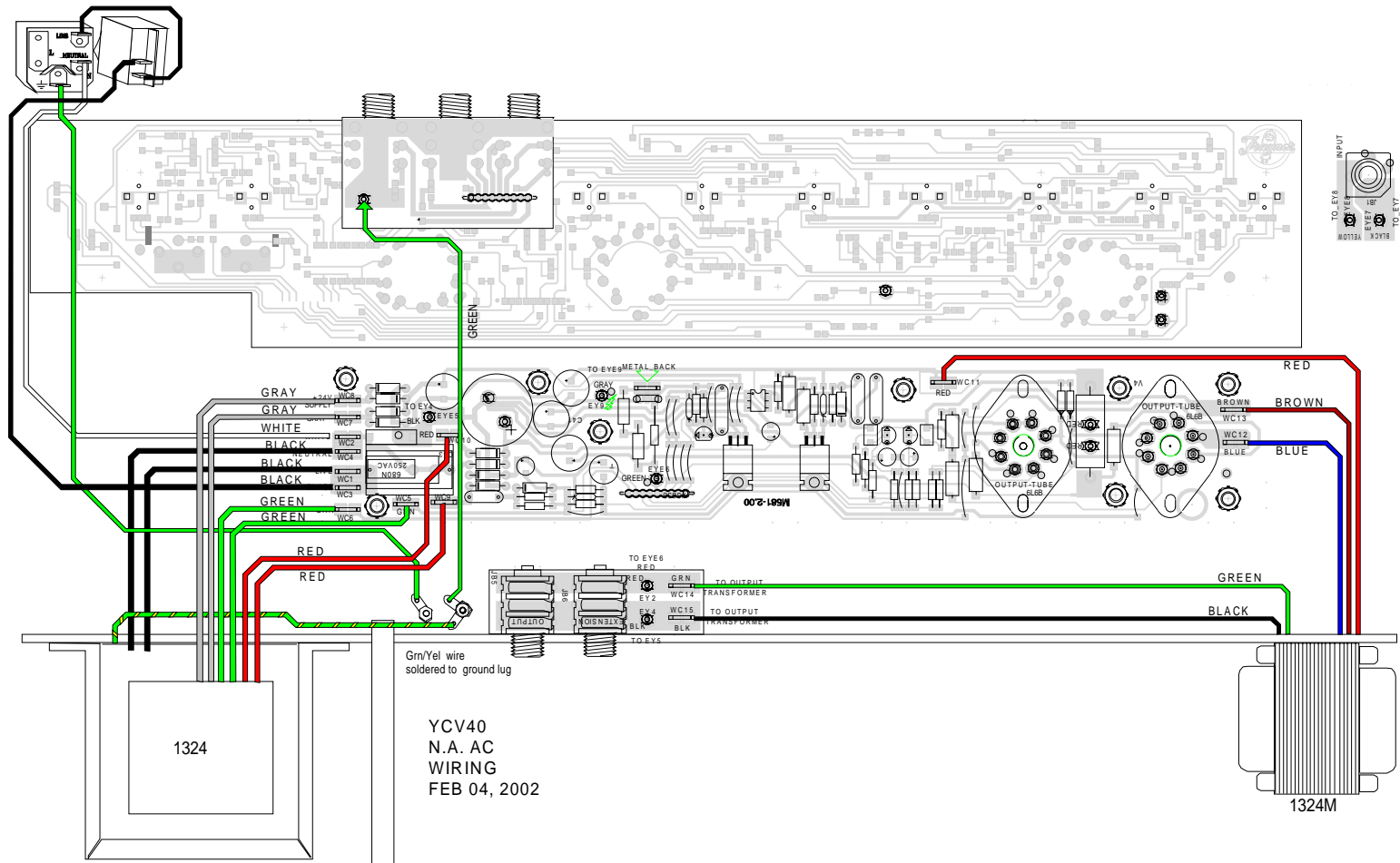

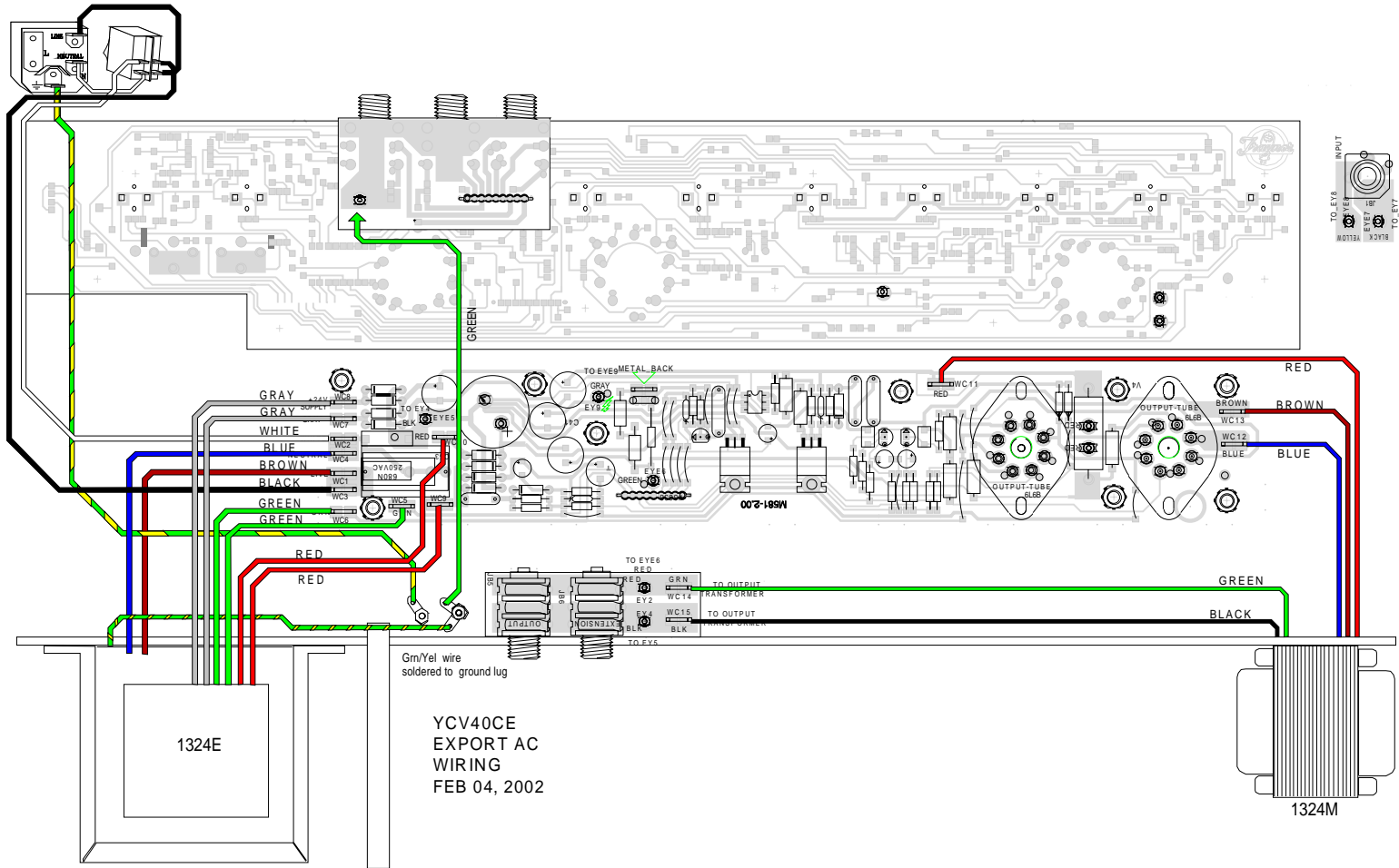

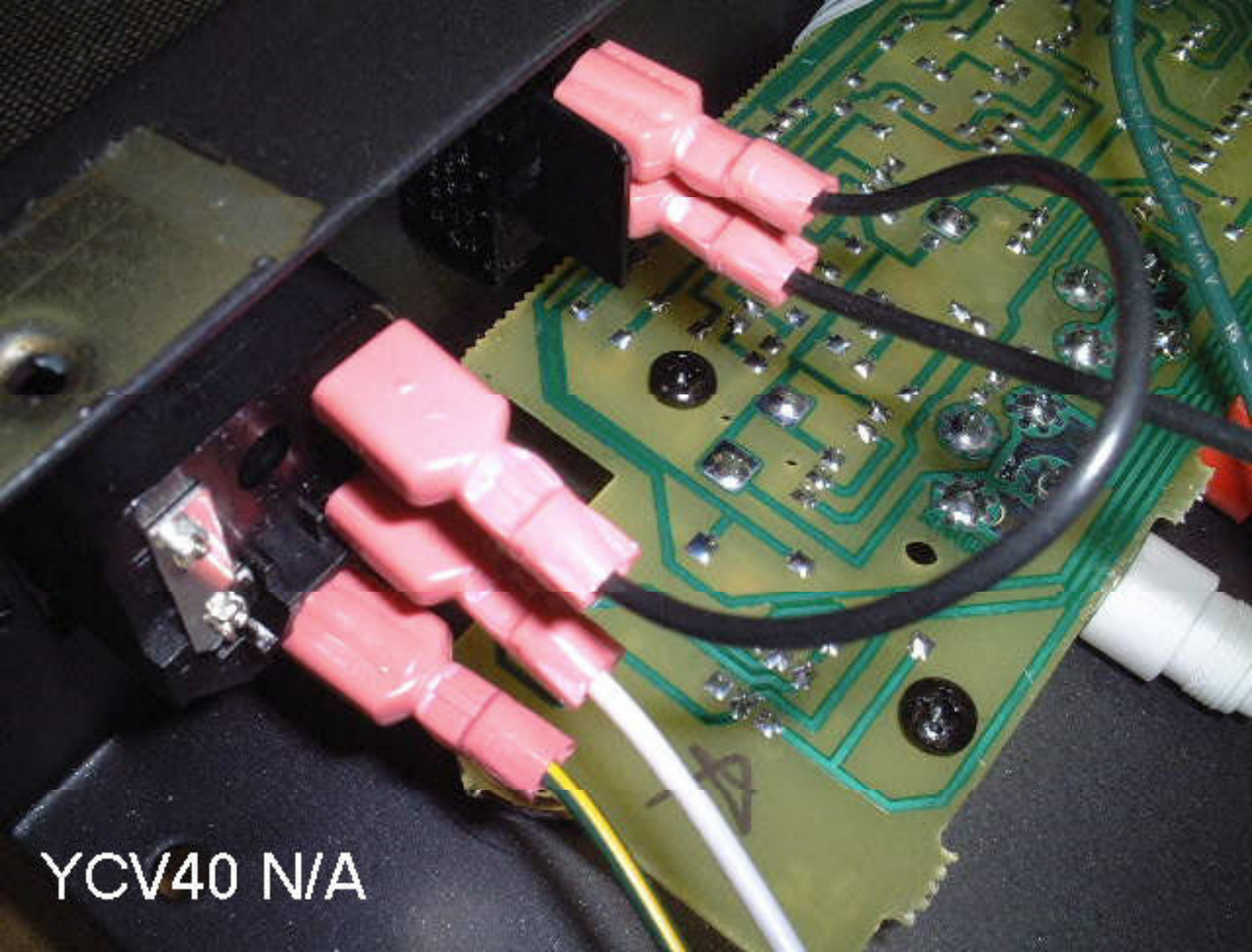

YCV40 N/A