

# Low Frequency Gain Phase Measurements

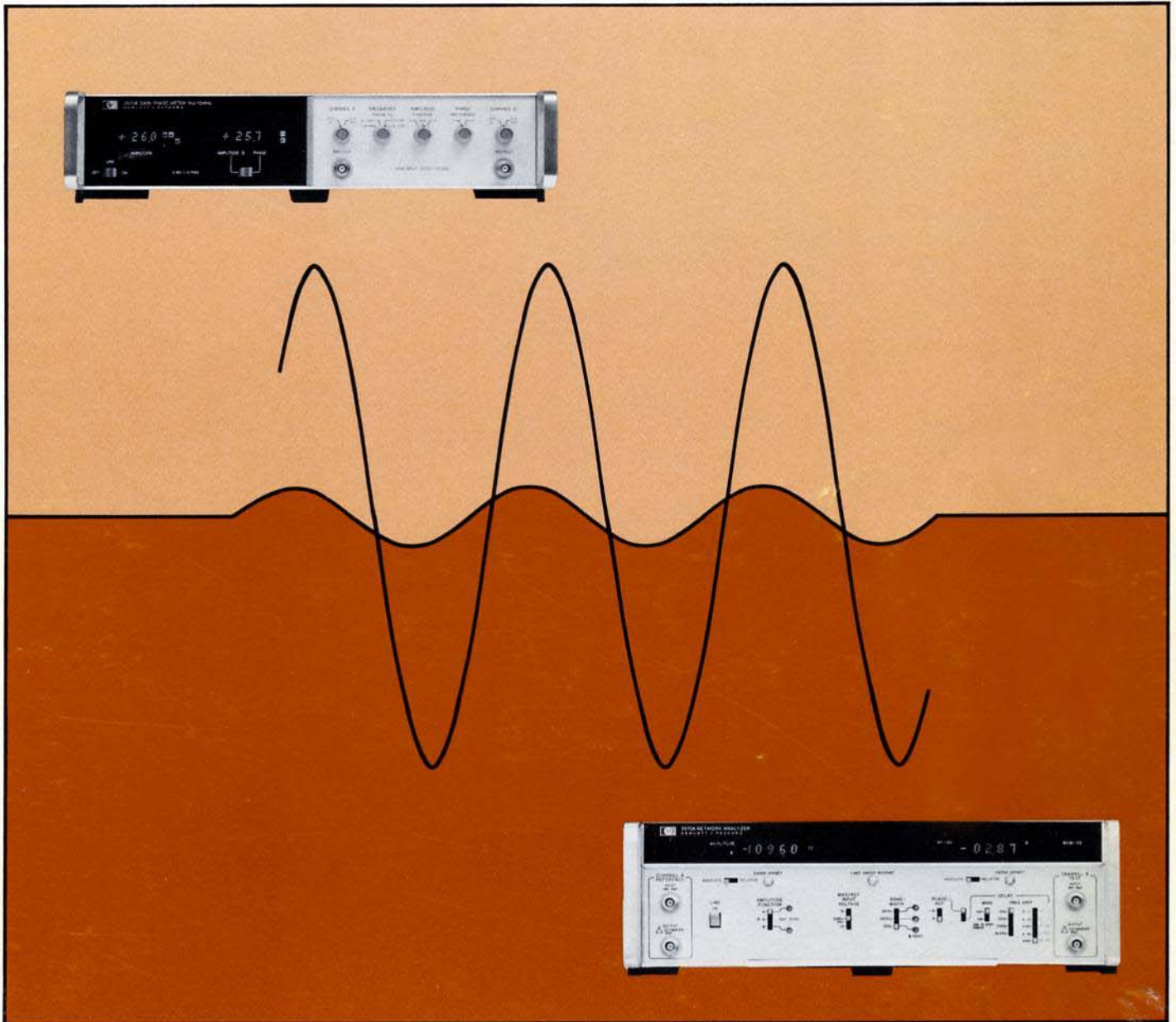

# Introduction

This application note has been written to bridge the gap between theoretical analysis and practical measurements. In the past, there were good reasons for avoiding phase measurements at low frequencies because of equipment limitations. Now there are many instruments designed specifically for low-frequency measurements. They range in capability from simple digital readouts and hand plotting to calculator-controlled network analyzers.

On the theoretical side, every textbook on feedback circuits has some discussion of the uses of phase. For that reason, schools have been the greatest proponents of phase measurement. On the practical side, time pressures of getting the job done and lack of equipment often don't allow time to explore different measurement possibilities. As a manufacturer of this type of equipment, we have spent a great deal of time solving real life customer problems. It has given us a knowledge of measurement solutions that you can use.

These applications are by no means exhaustive so they should stimulate your thinking to adapt them to your specific problem. Because the applications are so useful, many of them have been printed in the leading electronic trade publications. We have combined these articles by subject from the different magazines over the past year. We have further added new applications that have not been published.

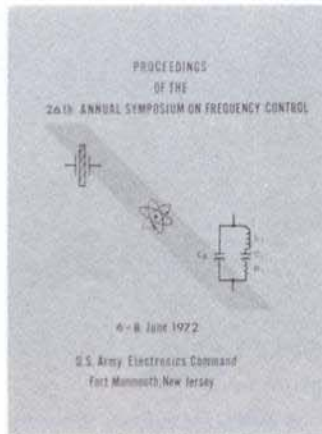
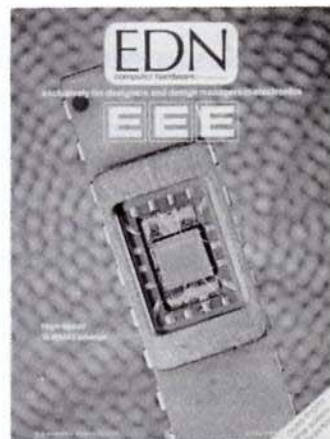

# Summary of Contents

## **Pole/Zero Measurements**

The response of filters is dependent on the frequency characteristics of the internal components. While a theoretical analysis enables the designer to select these components to give the desired response, circuit measurements are required to evaluate the realized response. This application shows how gain and phase measurements can be made to yield important relationships between component values and pole/zero locations.

4

## **Envelope Delay Measurement Techniques**

With the advent of multiplexed and digital signal transmission, delay measurements have become important to ensure undistorted signal transmission. To achieve distortion-free transmission, transmission paths must have constant delay characteristics over the channel bandwidth. The different techniques of measuring delay and the tradeoffs are discussed so the appropriate technique can be selected and used effectively.

6

## **Open/Closed Loop Measurements**

Feedback amplifiers present measurement problems because low level signals and DC offsets make the transfer functions difficult to measure. While it is generally easier to buy equipment to make closed loop measurements, the desired information is related to the open loop responses that are difficult to measure. This application shows how the open loop response can be derived from easy-to-measure closed loop measurements.

11

## **Impedance/Return Loss**

In some situations traditional impedance meters are not flexible enough for the required measurement. The applications presented here cover in-circuit, low impedance and impedance matching measurements that are not easily done with traditional impedance instruments.

13, 21

## **Crystal Evaluation**

Evaluation of crystal parameters requires unique instruments and calculations. The parameters that are found in this application are the resonant and antiresonant frequencies, Q and capacitive ratio. To arrive at the crystal parameters in traditional units a measurement algorithm and formulas to convert the analyzer readings to values of the parameters of interest are given.

14

16

### **Capacitor LRC**

At low frequencies, capacitors are characterized by the series equivalents of inductance, resistance, and capacitance. A conventional LRC meter won't evaluate all three elements. The simple technique described here evaluates all three.

18

### **Delay Line**

Delay lines are characterized by their time delay and its variation with temperature. Loss through the delay line is also of interest because it must usually be compensated for. These measurements can be done with a gain phase meter to greater resolution than with traditional instruments.

19

### **OP Amps/Rejection**

There are several characteristics of these universal building blocks that have to be measured. A gain phase meter is useful for investigating op amp compensation. The other parameter that can be investigated with a gain phase meter is rejection characteristics. Both common mode and power supply rejection are easily measured with such an instrument.

20

### **Integrators and Differentiators**

These devices are traditionally specified by their amplitude response to a step input. This is a difficult measurement to make because risetimes are not easy to evaluate. Instead of using a step response to evaluate integrators and differentiators, a sine wave response over the frequency range of interest can be used to characterize the devices with greater resolution and accuracy.

22

### **Instruments**

The measurement techniques shown for the preceding applications were given without reference to specific instrumentation because optimum instrumentation is not determined as much by the technique as by the user's requirements. Now that there are a large number of products and options to the basic products, the most expensive instrument is not necessarily the optimum. The chart given in this section summarizes the significant alternatives and their capabilities for the cost. It falls on the user to determine which combination of instruments fulfills his specific needs for the money available.

### Measure Phase Instead of Amplitude.

*It provides greater sensitivity and resolution, and makes frequency-response analysis a lot easier.*

In comparing the actual response of a new circuit with the theoretical, the odds are you've been using amplitude measurements about 90% of the time. You've probably used phase measurements in special applications only—to determine gain margin and phase margin, say. It may come as a surprise to you, but phase measurements have advantages in everyday design. You've probably been overlooking them.

For example, here are three common problems that phase measurements can help you overcome:

- Finding such circuit parameters as Q and natural frequency.
- Detecting small changes in a response curve.
- Locating poles and zeros in the complex plane.

Each of these problems requires considerable resolution. You can get it by buying more digits in a DVM, or you can solve the problem by measuring phase. Let's examine how.

#### Phase gives greater resolution

Consider low-Q networks, which exhibit slow amplitude changes with frequency changes. High resolution is needed to detect any change. Active band-pass filters are good examples of this situation.<sup>1</sup> Finding the natural frequency isn't easy when the frequency can be varied with no apparent change in amplitude. Fortunately the changes in phase can be very large. Fig. 1 contrasts the small amplitude changes with the large phase changes of one possible network.

As a numerical example of the possible improvements, a phase meter that can resolve 1/10th of a degree of phase has the inherent ability to resolve the natural frequency to  $\pm 7\%$  when  $Q=1/100$ . In contrast, amplitude is within 0.1 dB of its peak for  $Q=1/100$  over a two-decade frequency range. For the less extreme case, Fig. 1 shows the results when  $Q=2$ .

Finding the natural frequency may be only part of the problem. The measurement of Q itself may be difficult in practice. It should be possible to calculate Q from only three measurements. One is needed to find the natural frequency. Two more measurements will determine bandwidth. The equation  $Q = \text{natural frequency}/\text{bandwidth}$  gives the value of Q.

In trying to measure the bandwidth, you may run into problems, since the source voltage is not flat for changes in frequency. The problem is that the -3-dB point of the output is not independent of the

changing input (nonconstant input impedance of the network can be the source of this problem). The source and output voltages must be measured by the designer to find the true -3-dB points. Fewer measurements need be made if the ratio of the source to output voltages is measured. A gain-phase meter can perform this measurement and display dB ratio. Such an instrument makes these measurements easier because the basic equipment setup doesn't have to be changed.

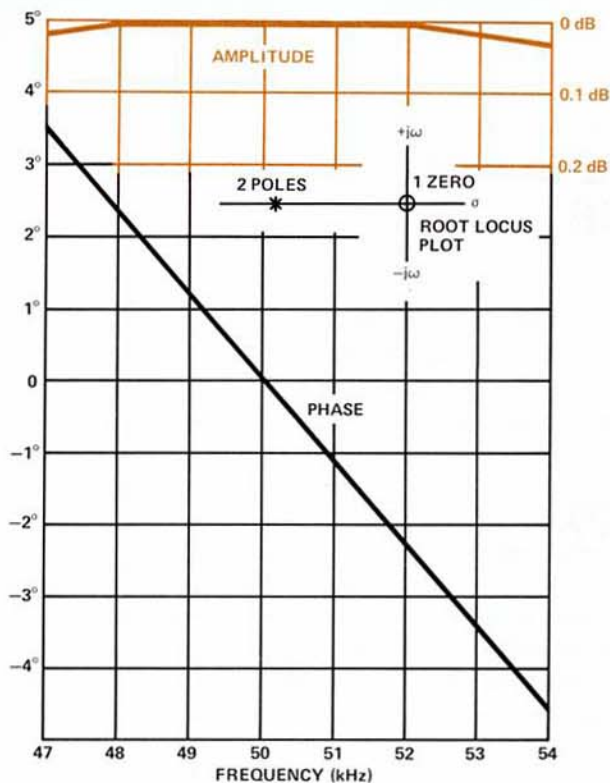

**Figure 1.** Comparison of phase and amplitude changes as a function of varying frequency. For  $Q = 2$  amplitude remains within 1/100 dB of its maximum, while phase changes  $7.9^\circ$ .

#### Phase gives greater sensitivity

The need to detect small changes in circuit response is another situation that is encountered regularly. You may know there is a glitch in the response curve, but measuring its size and location may be difficult because it is so small. In practice, this situation is encountered when the rolloff of an unwanted low-frequency pole is to be compensated for by a zero at the same frequency. Tailoring the response of an op amp is another application of pole-zero compensation.<sup>2</sup> And a similar situation exists when the characteristics of a simple lead or lag network are being investigated. In any of these applications the pole-corner frequency depends on component values, which may vary. Therefore to achieve maximum compensation, we must adjust the corner frequency of the zero.

This can be done by looking for amplitude changes. When the amplitude remains flat, the best compensation has been achieved. The resolution and accuracy of the measuring instrument determine the degree to which compensation can be achieved by measuring amplitude. However in this case, if phase remains flat, compensation will also have been achieved.

There are two advantages to using phase. One is greater sensitivity; the other is narrower bandwidth measurements. It is apparent from Fig. 2 that 75% of the change in phase can be observed with a measurement at either 0.1 f or 10 f and a measurement at 1 f. Measurements of amplitude at the same frequencies show only 50% of the total change. The conclusion is that to get better sensitivity in a narrow bandwidth, the change should be investigated with phase. Why is narrow bandwidth important? If the pole to be compensated occurs at 1 Hz, it may not be possible to make a measurement at 0.1 Hz because of limited low-frequency meter response. The phase measurement, however, could be made at 1 Hz and 10 Hz.

### Phase for design evaluation

The many articles which cover the design of active filters don't usually tell how to compare actual and theoretical response.<sup>3</sup> Many of these filter designs use complex roots to achieve their performance.

How do you measure the location of the complex poles? On the surface this would appear to be a simple problem since only two quantities need be measured to locate the roots.

Amplitude measurements are satisfactory for special cases in which the response to a step input is often displayed on a scope. The drawback is that the accuracy is directly proportional to the user's ability to count fractions of a small square on the scope. Another limitation is that the circuit under test may not respond as linearly to a step as it does to steady-state excitation.

If the step-response technique can't be used, a Bode plot may be feasible. The amplitude portion of the plot can be used to study the response in the frequency domain. All the necessary information for locating roots is in the amplitude plot. The problem is that the information is buried and must be retrieved by some rather awkward formulas.

A third technique is to make phase measurements. The location of complex poles and zeros can be found with two phase measurements. To locate the complex roots, the designer must find the natural frequency and damping ratio. The measurement of the natural frequency makes use of the fact that phase equals  $\pm 90^\circ$  at the natural frequency. This measurement is independent of the damping ratio.

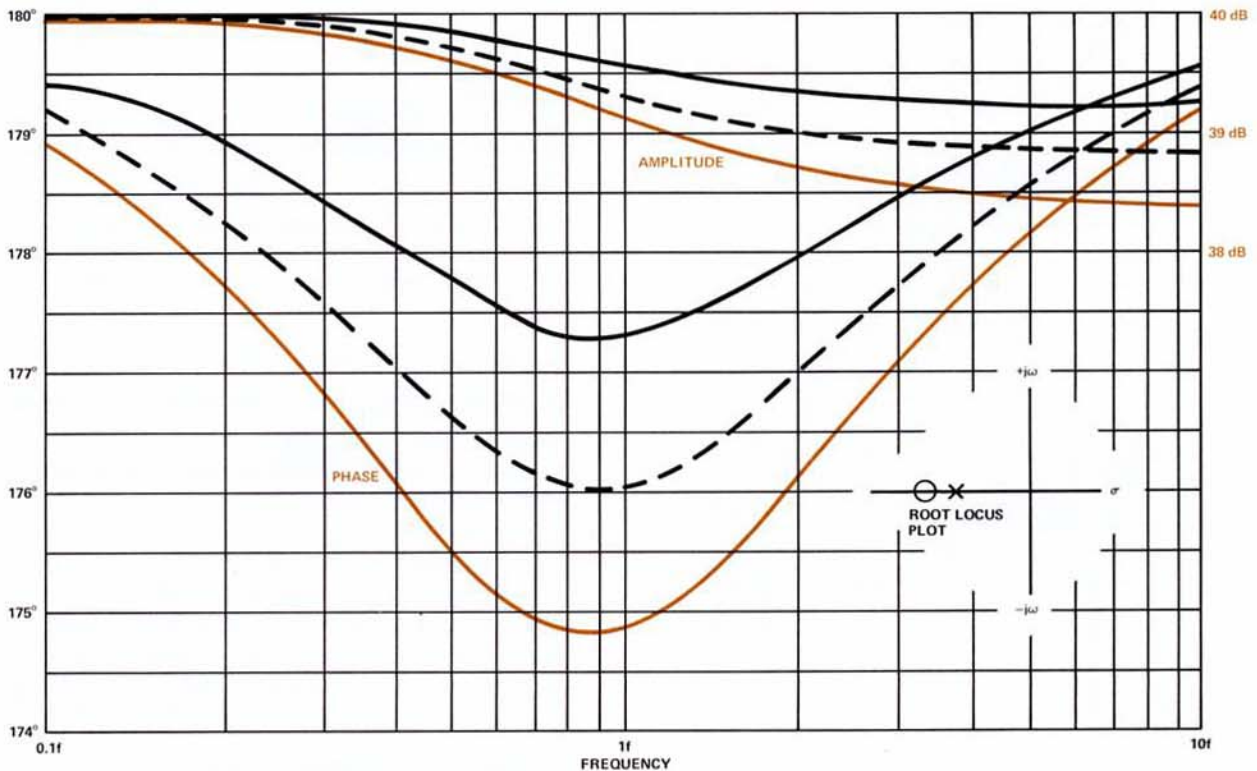

**Figure 2.** Pole-zero compensation using phase measurements. Phase change is much larger than amplitude change over the same frequency range. Greater sensitivity is obtained over a narrow bandwidth.

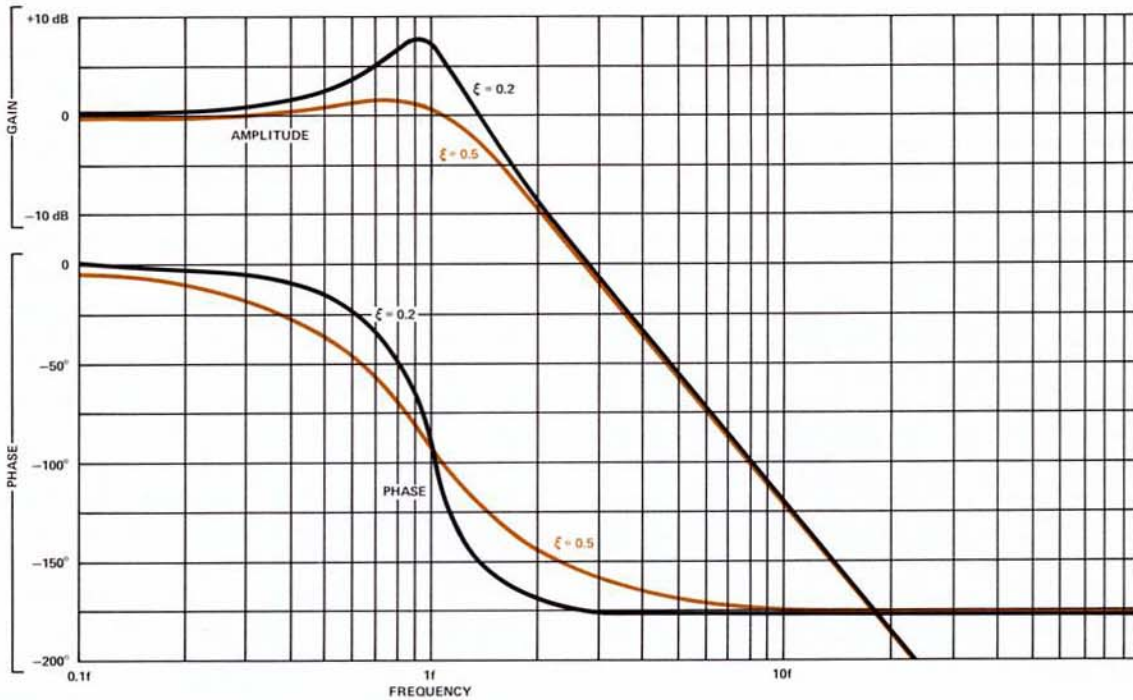

**Figure 3.** Amplitude and phase vs. frequency plots, with damping ratio as a parameter. Note that peak amplitude does not necessarily occur at the natural frequency. Phase, however, always crosses  $-90^\circ$  at the natural frequency. This measurement is independent of the damping ratio.

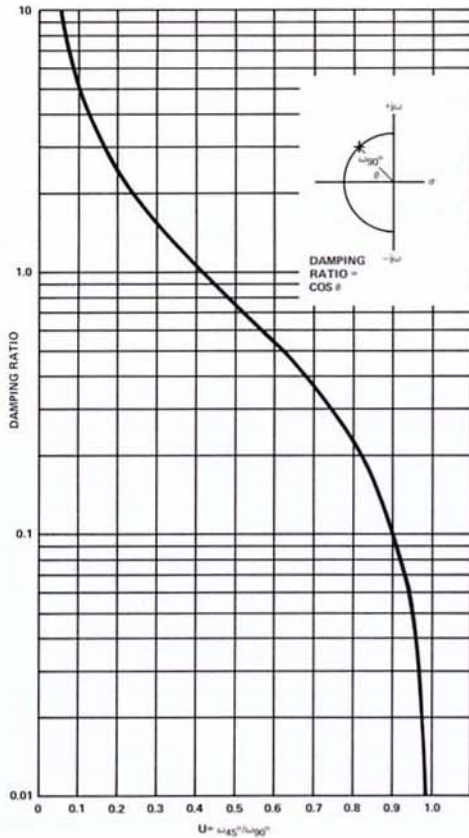

**Figure 4.** Damping ratio is found from Figure 3 by forming the ratio of the frequencies at  $-45^\circ$  and  $-90^\circ$ , i.e.,  $\xi = (1-U^2)/2U$  where  $U = \omega_{45^\circ}/\omega_{90^\circ}$ .

The next measurement determines the damping ratio. The slope of the phase plot changes with the ratio. Fig. 3 shows the effect of different damping ratios on both phase and amplitude. The phase plot passes through  $-45^\circ$  at different frequencies. This fact can be used to relate the frequency at  $-45^\circ$  to the damping ratio. Fig. 4 does this without further calculation.

**References**

1. Stremler, Ferrel G., "Simple Arithmetic is an Easy Way to Design Active Bandpass Filters," *ELECTRONICS*, June 7, 1971, p.86-89.
2. Payton, Gary L., Warren, Morris I., "Custom Compensate Your Op Amp," *ELECTRONIC DESIGN*, January 7, 1971, p. 92-95.
3. Russell, Howard T., "Design Active Filters with Less Effort," *ELECTRONIC DESIGN*, January 7, 1971, p. 82-85.

Reprinted from *FREQUENCY TECHNOLOGY*, April, 1970.

**Envelope Delay Measurement Techniques**

**James A. Hall**

Telecommunication Products Department, General Electric Comp, Lynchburg, Virginia

**I. Introduction**

This paper outlines the general techniques involved in envelope delay measurements and reviews the trade-offs involved. Also, a method is shown whereby commercial test equipment plus a minimum of external circuitry can be utilized to measure envelope delay for a variety of requirements.

**II. Point-by-Point Measurement of Envelope Delay**

Envelope delay is defined as the rate of change of phase with respect to frequency.

$$\text{Envelope Delay} = \frac{d\phi}{d\omega} \text{ seconds} \quad (1)$$

To facilitate envelope delay measurements, changes in phase shift ( $\Delta\phi$ ) are usually measured for fixed increments of frequency ( $\Delta f$ ) at various frequencies of interest. Using this technique,<sup>1</sup> values of  $\Delta\phi$  may be related to envelope delay by a constant factor.

$$\text{Envelope Delay} = \frac{\frac{2\pi \text{ radians}}{360 \text{ degree}} \times \Delta\phi \text{ degrees}}{2\pi \Delta f \frac{\text{radians}}{\text{seconds}}} = \frac{\Delta\phi \text{ second}}{360 \Delta f} \quad (2)$$

For constant  $\Delta f$ ,

$$\text{Envelope Delay} = K\Delta\phi \text{ seconds} \quad (3)$$

Use of the  $\Delta f$  values given in Table I are convenient since they result in even values of K.

**Table 1**  
K as a Function of  $\Delta f$

$\Delta f$	K(seconds per degree)
2.778 kHz	1 x 10 <sup>-9</sup>
277.8 kHz	10 x 10 <sup>-9</sup>
27.78 kHz	0.1 x 10 <sup>-6</sup>
2.778 kHz	1 x 10 <sup>-6</sup>
277.8 Hz	10 x 10 <sup>-6</sup>

It is apparent from Table I that the requirements for resolving rapid changes (as a function of frequency) in envelope delay and high sensitivity are conflicting. For example, if a large value of  $\Delta f$  is used, a small change in envelope delay will give a large change in phase (high sensitivity), but discontinuities or ripples in the delay curve tend to be overlooked or averaged out (poor resolution). Conversely, if a small  $\Delta f$  is used, the resolution tends to be good, but the sensitivity poor.

For the above reasons, the value of  $\Delta f$  should be carefully chosen to give the best compromise between sensitivity and resolution for a particular measurement.

### III. Swept Envelope Delay Measurements

To measure envelope delay on a swept basis, a different technique from that used for point-by-point measurement is employed. Basically, low frequency ( $f_m$ ) amplitude modulation is applied to the carrier frequency ( $f_c$ ). Figure 5A shows the frequency spectrum of this AM signal, with a carrier, upper sideband ( $f_c + f_m$ ) and lower sideband ( $f_c - f_m$ ). Figure 5B shows the relative phases of these signals at some instant of time, where  $\bar{A}$ ,  $\bar{B}$ , and  $\bar{C}$  are the carrier, upper sideband, and lower sideband frequencies respectively. The arrows on  $\bar{B}$  and  $\bar{C}$  show how their phase is varying with respect to the carrier  $\bar{A}$ . Since  $\bar{B}$  is moving CCW (the same direction the carrier rotates), it is moving faster than the carrier and therefore represents the upper sideband. Similarly,  $\bar{C}$  is moving CW (opposite in direction to the carrier) and represents the lower sideband.

If the signal of 5B is passed through a circuit with a phase shift which increases linearly with frequency (constant time delay), the representative signal shown in 5C results. This is because the lower sideband frequency encounters less phase shift than the carrier while the upper sideband encounters more phase shift than the carrier. The net result of these phase shifts is that the modulation envelope of the output signal is shifted in phase with respect to the input signal. The amount of envelope phase shift is directly proportional to the difference in phase shift of the carrier and sideband frequencies (or slope of the phase versus frequency curve). This is further illustrated in Figures 5D and 5E which show the modulation envelopes corresponding to the vector diagrams of Figures 5B and 5C.

This technique, though different, turns out to be similar in principal to the point-by-point method of Section II, with the difference in phase shift at the carrier and sideband frequencies equivalent to  $\Delta\phi$  and the modulation frequency equivalent to  $\Delta f$ .

Since the modulation frequency is constant, regardless of the carrier frequency, the delay time is simply  $K\Delta\phi$  where:

$$K = \frac{\text{seconds}}{\text{degree}} = \frac{1}{360 \frac{\text{degrees}}{\text{cycle}} \times f_{\text{modulation}} \frac{\text{cycles}}{\text{second}}} \quad (4)$$

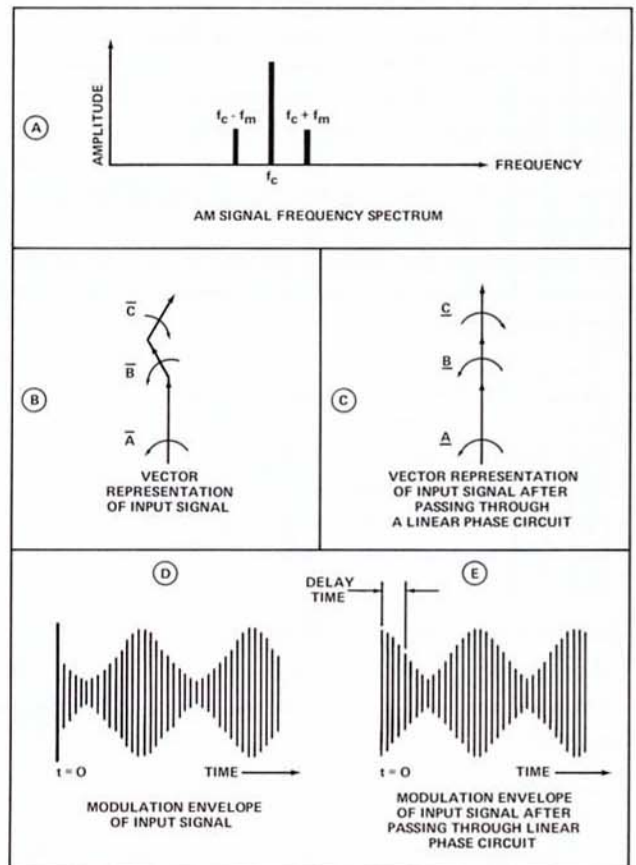

**Figure 5.** Effect of envelope delay upon an a-m signal.



A phase curve which is not a linear function of frequency complicates the above description somewhat since in general the two sideband frequencies will be shifted in phase by different amounts with respect to the carrier. This results in both phase and amplitude modulation of the carrier. Since an AM detector is used to recover the modulation, the phase modulation does not affect the envelope delay measurement. However, the modulation envelope phase shift now depends upon an "average" of the phase shifts of the two sideband frequencies. For this reason, it is necessary to use a value of  $f_m$  somewhat lower than the highest envelope delay ripple frequency to obtain good resolution. A high value of  $f_m$  must be used to obtain the maximum change in phase for a given change in envelope delay. Therefore, the same constraint exists in swept measurement as one faces in the point-by-point measurement. Similarly,  $f_m$  must be chosen to give the best compromise between sensitivity and resolution.

#### IV. Phase Comparison Techniques

Another method of measuring envelope delay is simply to display the phase versus frequency curve of a circuit on an oscilloscope. Then the envelope delay at a particular frequency is directly proportional to the slope of the curve at that frequency. Usually this technique is not satisfactory since the envelope delay of most circuits is composed of relatively small delay time variations or distortions superimposed upon a relatively large constant delay time. For this reason, on a direct phase/frequency presentation the linear component of the curve usually dominates the display. However, if the linear phase variation is subtracted from the overall phase curve, a much more accurate estimation of the phase nonlinearities can be obtained.

To illustrate the difference between this technique and other methods of group delay measurement, consider a phase curve:

$$\phi_1(\omega) = K_1\omega + K_2\omega^2 + K_3\omega^3 + K_4\omega^4 + \dots \quad (5)$$

where:

- $K_1$  is the linear phase coefficient
- $K_2$  is the parabolic phase coefficient
- $K_3$  is the cubic phase coefficient
- $K_4$  is the quadraic phase coefficient,
- etc.

If the linear phase term is removed, then

$$\phi_2(\omega) = K_2\omega^2 + K_3\omega^3 + K_4\omega^4 + \dots \quad (6)$$

However, the envelope delay of the original curve (Equation 5) is:

$$\frac{d\phi}{d\omega} = K_1 + 2K_2\omega + 3K_3\omega^2 + 4K_4\omega^3 + \dots \quad (7)$$

The above relations illustrate two important facts. First, the amount of linear phase to be subtracted can be experimentally determined since only the  $K_1\omega$  term has

a linear component. For this reason, we can simply observe the phase/frequency curve and subtract various amounts of linear phase until zero phase slope is obtained at the center measurement frequency. Although Equations (5), (6), and (7) relate only to a low pass type response (all terms are symmetrical with respect to zero frequency), the same approach can be used for a bandpass type response (where all terms can have a linear phase component). In either case, the amount of linear phase subtracted to obtain zero phase slope at the center frequency is related to the constant delay time by Equations (3) and (4).

The second important fact, as shown in Equation (6), is that when the linear phase term is subtracted from the phase curve, the response is still a phase response and must be differentiated to obtain the envelope delay terms which are functions of frequency.

Figure 6 illustrates a test configuration which allows the subtraction of a linear phase from the Phase/frequency curve of the unit under test. The major problem with instrumenting such a test setup is obtaining an adjustable linear phase network, particularly for measuring bandpass networks which might typically have several microseconds of constant delay (equivalent to several thousand feet of cable).

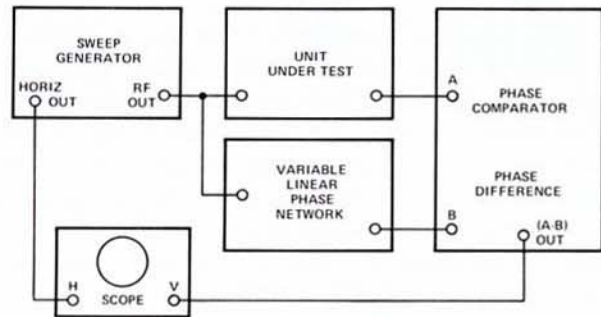

Figure 6. Test connection for eliminating linear phase shift.

An alternative approach suitable for production testing is to replace the linear phase network with a standard unit which has a phase response equal to that desired for the unit under test. Here the unit under test needs only to be aligned to conform in amplitude and phase response to the standard. One disadvantage of this method is that for most requirements only the non-linear phase is important. The above method adds the unnecessary constraint (usually) that the linear phase of both units be identical. Also there are the usual problems of maintaining and verifying the long term integrity of the standard unit.

With this technique, the task of evaluating the actual time delay difference between the standard unit and the unit under test is simple and accurate since:

$$\text{Time difference (seconds)} = \frac{\text{phase difference (degree)}}{360 \times f \text{ carrier (Hz)}} \quad (8)$$

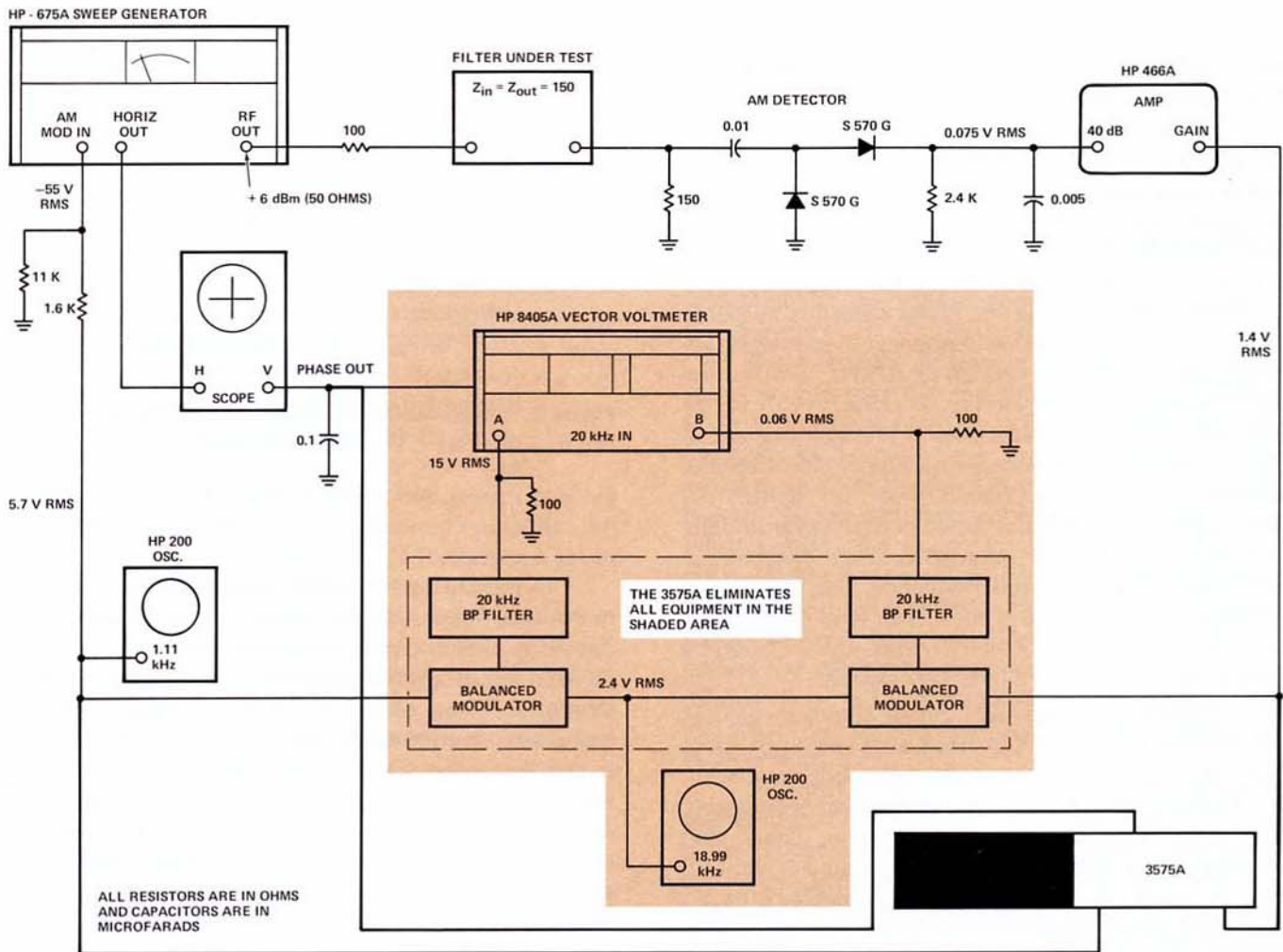

Figure 7. Group delay test setup (1.11 kHz measuring frequency).

Therefore for relatively high filter center frequencies, excellent resolution is obtained. Note also that the time calibration is a function of the carrier frequency. This is not significant in narrowband filter tests, but obviously is important in wideband filters.

Although the resolution in matching the time delays of two units is excellent, measurements of the actual shape of the "difference" involves the same limitations pointed out in Section II, Point-by-Point Measurement of Envelope Delay. This is true since one still must either visually or graphically differentiate the "difference" phase curve to obtain the magnitude and shape of the frequency dependent envelope delay terms.

## V. Envelope Delay Test Sets

Recently, we had an application requiring the measurement of the envelope delay of a filter with a 48 kHz bandwidth to accuracy of approximately 0.25 microseconds. To investigate the feasibility of utilizing in-house test equipment for envelope delay tests, the

circuitry shown in Figures 7 and 8 was connected and its performance evaluated. Most of this circuitry is available commercially except for the 20 kHz filter. The basic measurement technique employed is that described in Section III.

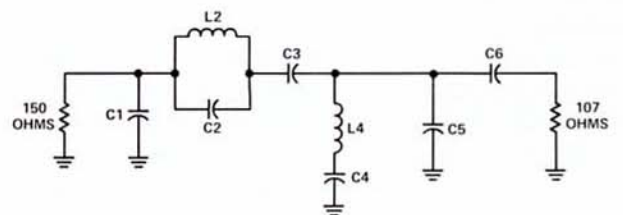

VALUES: C1 = 0.04236  $\mu$ f      C4 = 0.09064  $\mu$ f  
 C2 = 0.05247  $\mu$ f      L4 = 0.08625 mH  
 L2 = 0.997 mH      C5 = 0.3545  $\mu$ f  
 C3 = 0.01208  $\mu$ f      C6 = 0.09138  $\mu$ f

SPECIFICATIONS: PASSBAND, 19.7 – 20.3 kHz  
 PASSBAND RIPPLE,  $\leq$  0.5 dB  
 ATTENUATION AT 19 kHz  $\geq$  20 dB  
 ATTENUATION AT 18 kHz  $\leq$  60 dB  
 ATTENUATION BELOW 18 kHz  $\geq$  32 dB

Figure 8. 20 kHz Bandpass

The operation of this circuit is as follows: Amplitude modulation of the sweep generator carrier at 1.11 kHz is introduced at the external AM modulation input.

This amplitude modulated carrier passes through the filter under test, the modulation is recovered in an AM detector, and the resultant 1.11 kHz signal amplified by approximately 40 dB. It would be possible to compare the phase of the input 1.11 kHz to the demodulated 1.11 kHz if a phase detector for this frequency were available. Since none of the phase detectors available to us would operate at this frequency, it was necessary to heterodyne the 1.11 kHz up to 20 kHz, which is the input frequency of the Hewlett-Packard 8405A vector voltmeter. The 20 kHz bandpass filter after the balanced mixer is necessary to remove the upper sideband and remaining carrier components from the desired 20 kHz signal. The filter has poles placed symmetrically with respect to 20 kHz in order to obtain symmetrical envelope delay about this frequency. This precaution probably is not necessary, but it does tend to minimize any error in the phase detector output signal caused by drift in the 1.11 kHz or 18.89 kHz signals.

Commercially available phase detectors such as the HP8405A and HP676A have a resolution of about  $0.1^\circ$ . This value seems to be the best obtainable without resorting to special (and expensive) techniques. The phase resolution sets the minimum phase shift which can be accurately measured. Figure 9 shows a plot of envelope delay resolution available with the Hewlett-Packard phase meters as a function of modulation (measuring) frequency.

Figure 9 shows that the desired 0.25 microsecond resolution is obtained with a measuring frequency of approximately 1 kHz. The exact frequency of 1.11 kHz was chosen to give a phase change of 0.4 degrees for 1 microsecond envelope delay variation.\* With this measuring frequency, delay ripples with a  $\cong 2$  kHz period will be resolved. By referring to Figure 5 and keeping in mind that the test will accurately resolve ripples with a period of approximately  $\cong 2 f_{\text{modulation}}$ , other measuring frequencies can be chosen for the optimum performance in a particular requirement. If test frequencies much lower than 1 kHz are desired, the mixer output filter should be redesigned for more selectivity. Measuring frequencies higher than 1 kHz should be usable with no modification to the circuit.

Except for the above problem, only the precision of the measuring signal frequency and the phase detector calibration determines the overall test circuit accuracy. The measuring frequency is set with a counter, therefore

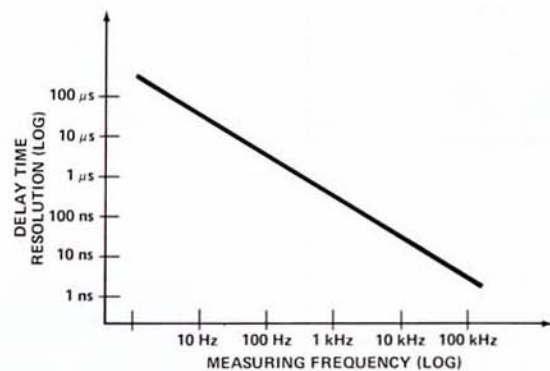

**Figure 9.** Maximum envelope delay resolution vs. measuring frequency for  $0.1^\circ$  phase meter sensitivity.

the total measurement error should be no worse than the calibration accuracy of the HP-8405A and HP-676A phase detectors.

To modify the HP-8405A Vector Voltmeter for use in this type of test, the RF circuitry must be disabled by removing printed circuit boards A3, A4, and A10. The 20 kHz inputs are then applied to the 20 kHz output terminals. When using the HP-676A phase detector, a crystal controlled local oscillator signal of 99.78 MHz is applied to the 100-132 MHz input. This frequency was chosen to provide a 20 kHz input frequency so that the same filters used with the HP-8405A could be retained. By changing the crystal oscillator frequency, the phase of signals anywhere in the 10 kHz to 32 MHz range can be measured.

#### UPDATE 1973

At the time this article was written, the HP Models 3575A and 3570A were not available, so their delay capabilities were not mentioned. Figure 7 shows how the 3575A could be used to simplify delay measurements using the AM technique.

The 3570A Network Analyzer uses the point-by-point technique, also discussed in the article. With the frequency sweep capabilities of this instrument, delay can be measured around two frequencies; or the frequency can be swept, and delay continuously measured over the swept frequency range.

In comparison to the  $\Delta f$ 's shown in Table 1, it offers 20  $\Delta f$ 's ranging from 5 Hz to 166 kHz. The delay in seconds is AUTOMATICALLY CALCULATED; so a wider variety of  $\Delta f$ 's can be used with this instrument than is feasible, using a manual setup. Resolution with this instrument ranges from  $10^{-12}$  to  $10^{-5}$  seconds, depending on the  $\Delta f$  selected.

## Open/Closed Loop Measurements

Feedback amplifiers that are used to provide amplification or are used as filters have changing gain and phase characteristics with frequency. Regardless of the application, the designer wants to know what the closed loop gain and phase response look like as a function of frequency. Figure 10 shows the open loop response for a three pole transfer function. The open loop gain is never flat with frequency but is always rolling off. For a unity gain amplifier, this plot would never be sufficient. The closed loop gain is flat at low frequencies and then peaks between 1 Hz and 10 Hz. This plot shows how feedback can be used to flatten amplifier characteristics. While the designer is most interested in the closed loop response this may be impractical to measure because the amplifier is oscillating. Breaking the loop will stop oscillations but now the closed loop response cannot be measured directly. To convert from open loop measurements a conversion to the closed loop equation is necessary.

## Nichols Charts

Nichols charts are very powerful tools for determining closed loop responses from open loop measurements. Alternatively, open loop measurements may not be possible because the gain of the amplifier is so great that the input signal saturates the output of the amplifier. Nichols charts represent one technique that can be used to convert closed loop measurements to open loop response. Open loop response is plotted on the rectangular grid. The closed loop response is found from the contour lines of phase and gain. Figure 10 shows a closed loop peaking of 6.8 dB. Looking at the contour lines labeled dB on the Nichols chart in Figure 11 the plot just crosses over the 6 dB contour. Therefore the information in either figure is the same.

If there were more gain in this amplifier the Nichols chart would be shifted up and the peaking would be greater. The gain can be increased to the point where the plot goes through the center of the dB contours and oscillations would result. This coincides with

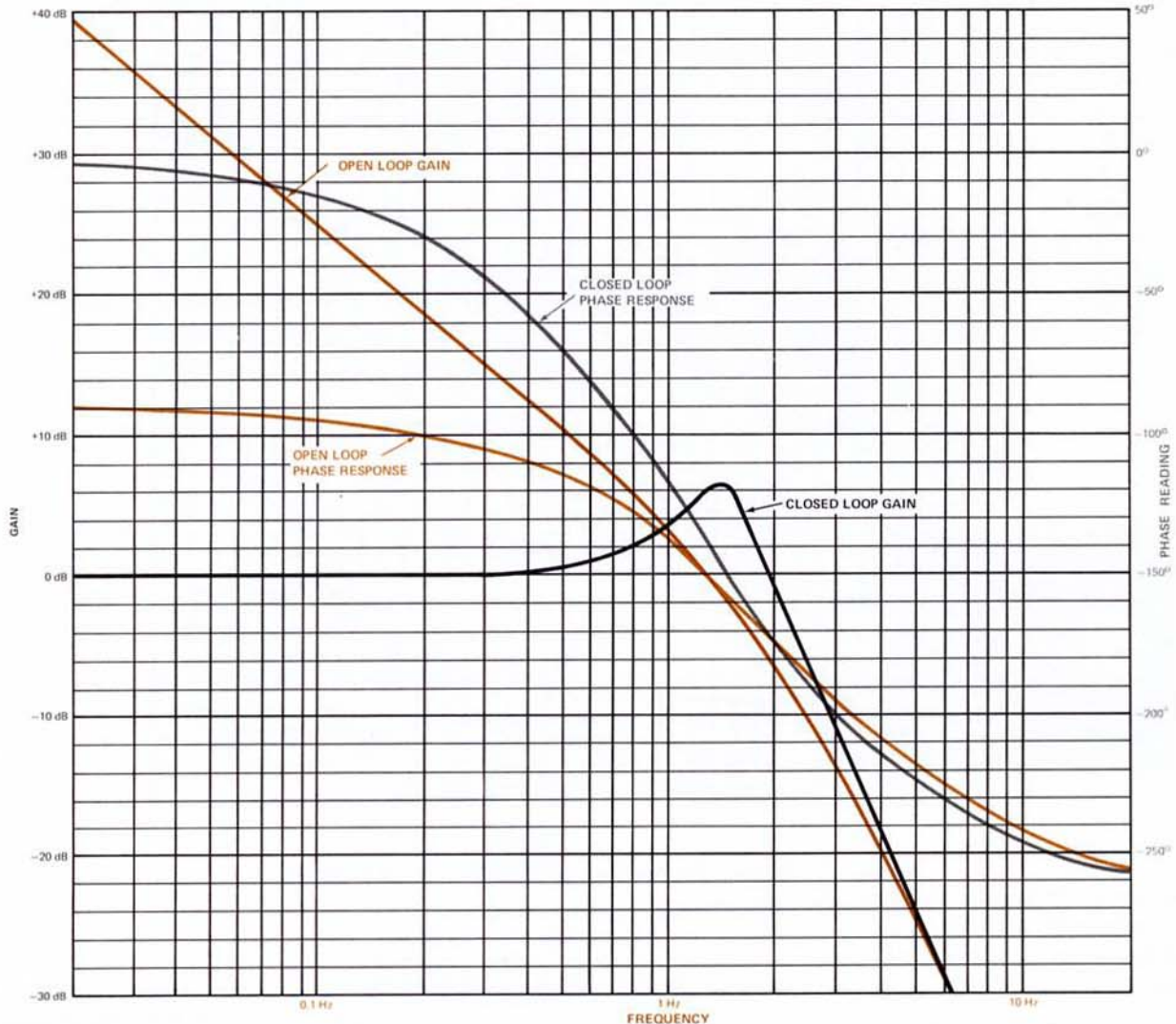

Figure 10. Open/Closed loop measurements

the stability criteria that says the open loop response should be below 0 dB by the time  $-180^\circ$  of phase shift is encountered.

With the instruments available for gain and phase

measurements the Nichols chart becomes easy to use in practical situations. By making either open or closed loop measurements the complete response picture becomes available.

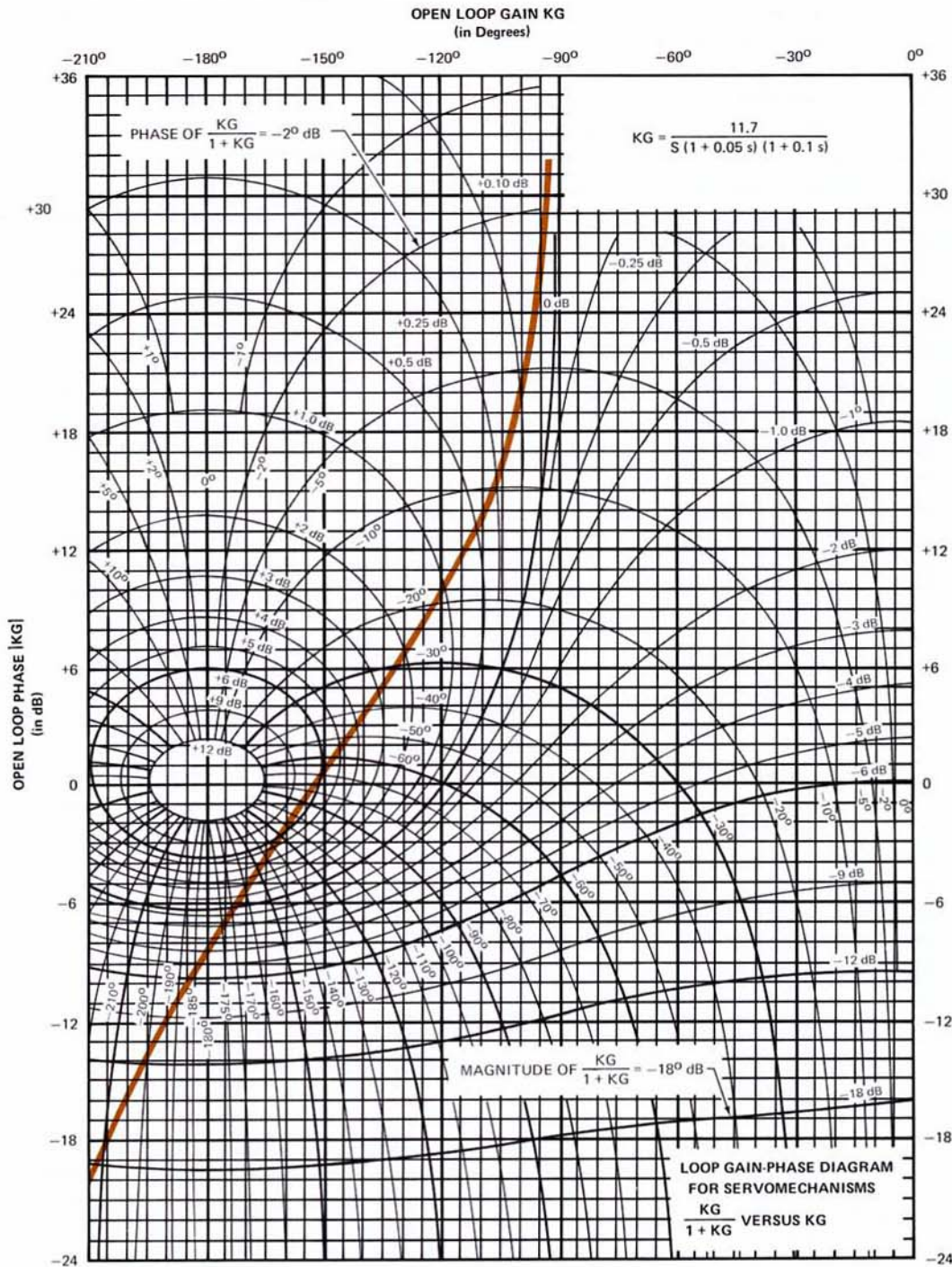

Figure 11. Nichols Chart showing Loop Gain-Phase Diagram.

Reprinted from ELECTRONICS, March 27, 1972;  
Copyright McGraw-Hill Inc., 1972

### Closed Loop Measurements

We have shown one example where Nichols charts can be used to find open loop gain from closed loop measurements. There is another technique that

can be used for the same measurement.

In this example measuring the closed-loop response of regulated power supplies can be a tricky

problem, particularly when operational amplifiers are used. Even though IC makers supply frequency-response plots for their devices, closed-loop response problems always pop up when an additional pole or zero is picked up from the pass transistor and filter. The total loop response now depends on both the op amp and the additional circuitry.

Unfortunately, measuring open-loop response requires breaking into a high-gain loop, which isn't very practical. It is much better to determine the open-loop response with the loop closed.

Simply add an ac voltage source, dc-coupled and floating in series with the feedback path. Now determining open-loop gain is almost reduced to reading a meter.

Although the oscillator's signal isn't critical, it should be low enough for the amplifier to remain linear. An oscilloscope can be used to monitor the signal.

The open-loop response of an amplifier with gain A and feedback function can be expressed as:

$$A\beta = \frac{E_{out}}{E_{in}} \left[ 1 + \frac{Z_{out}}{Z_{in}} \right]$$

If  $Z_{out}$  is much less than  $Z_{in}$ , then the expression reduces to  $E_{out}/E_{in}$ . The gain and phase plot to  $E_{out}/E_{in}$  is

### Return Loss

In some cases, the absolute impedance is not important as the match between two impedances. A mismatch implies standing waves on a line and something less than maximum power transfer. One way of

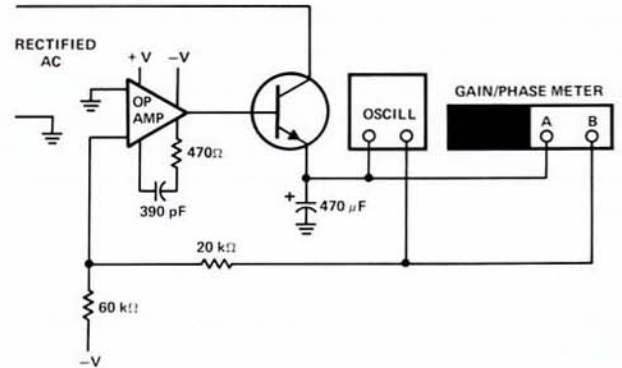
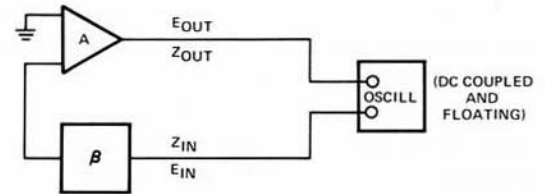

**Figure 12.** Typical test setup needs floating direct-coupled oscillator.

a simple Bode plot. The instruments shown in the last section are well suited for this role because they measure the log ratio of  $E_{out}$  and  $E_{in}$  and the phase between them.

approaching this problem is to say that if there is no power reflected back to the source from impedance discontinuities, then the return loss is very large with maximum power transfer and no standing waves.

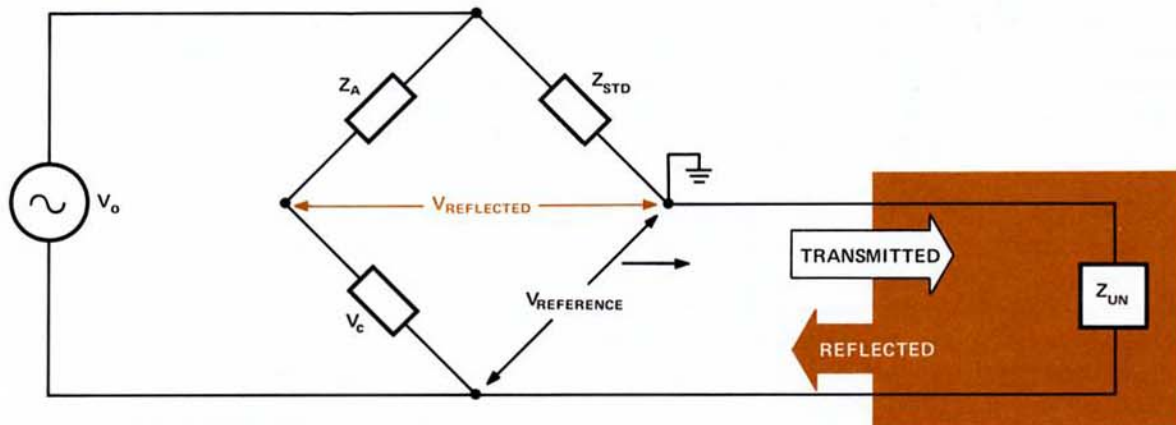

#### MEASURE

$$20 \text{ LOG } \frac{V_{REFLECTED}}{V_{REFERENCE}} = \text{dB}$$

FOR  $Z_A = Z_C$

There will be no reflected voltage when  $Z_{STD} = Z_{UN}$ . In all other cases, a reading of negative dB will indicate the amount of mismatch in both the real and imaginary parts of the reference and unknown.

**Figure 13.** Measurement of transmitted and reflected voltages using a directional coupler.

To measure the transmitted and reflected voltages a directional coupler is needed. At microwave frequencies, directional couplers are common; at lower frequencies, a resistance or transformer bridge can be made to do the same job. When the bridge is balanced (impedances are matched), the voltage across the reflected diagonal will be zero. The reflected power will be zero, but the transmitted power will not be zero. Therefore, the ratio of reflected to transmitted will be zero or  $\infty$  in dBs. The voltage across the unknown line gives an indication of power transmitted. When the bridge is not balanced, the reflected voltage will appear across the reflected diagonal. The 3575A can measure the log of the ratio of these two voltages to give an indication in dB of return loss.

Based on article in 26th ANNUAL SYMPOSIUM ON FREQUENCY CONTROL, 6–8 June 1972.

### Crystal Analysis

Crystal analysis presents many measurement problems because crystal characteristics change radically around the resonant frequency. Figure 14 shows the amplitude and phase response of a typical crystal where these changes occur over a very small frequency span. While the basic characteristics of crystals are very useful to the designer, the measurement can be very difficult. Unless a stable frequency source with a very pure sine wave output is used, measurements of amplitude and phase on the crystal have no stable value. The frequency source must also have good frequency resolution so the resonant frequency can be resolved to the required sensitivity. For these reasons a frequency synthesizer such as the HP 3330B is necessary. With this one requirement in mind the actual measurements of amplitude and phase response of the crystal can be made with a variety of instruments as shown in the last section of this application note.

Another one of the difficulties encountered in crystal measurement is that most of the parameters of interest must be mathematically derived from the measurement data. The mathematical deviation becomes necessary because the parameters are inter-related and can't be measured directly. The primary advantage in allowing a calculator to automatically make the measurements is the elimination of data recording and reduction. The system can gather the data, process it, and present it to the operator in the most convenient form.

The crystal is assumed to be represented accurately enough by the equivalent circuit shown in Figure 15. Further, it is assumed that the Q of the motional arm is sufficiently high that off resonance, the motional arm admittance is negligible, and at series resonance, the admittance of  $C_0$  is negligible.

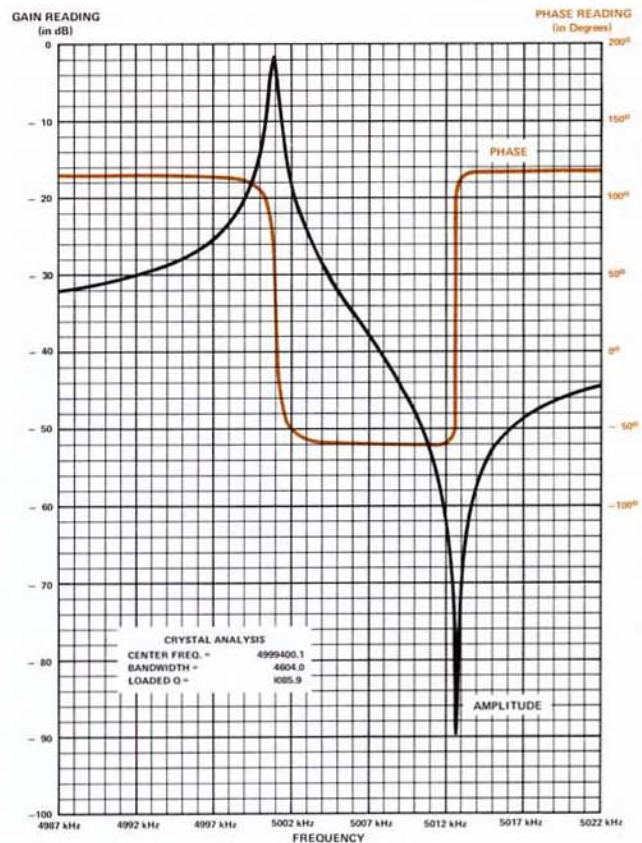

Figure 14. Crystal Analysis

The following algorithm to be described is designed to test crystals over a wide range of frequencies and power levels. It is not the most accurate or sophisticated method possible, but was designed to make calculations of the equivalent circuit parameters based on as few highly accurate measurements as possible with a synthesizer and network analyzer.

The test jig used simply places the crystal in series with a 50  $\Omega$  source and a 50  $\Omega$  load. To allow more accurate level measurement, an RF reed relay can be built into the jig to allow shorting out of the crystal socket. Using this jig, the basic measurement made is the complex insertion gain of the crystal network given by:

$$G = \frac{R_T}{R_T + Z_C}$$

$R_T$  = Test impedance = 100  $\Omega$

$Z_C$  = Complex impedance of crystal including any shunting stray capacitance.

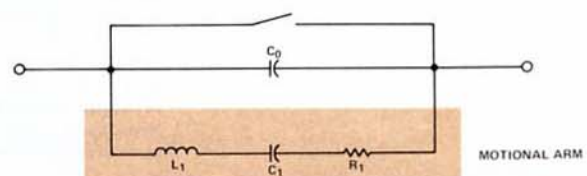

Figure 15. Crystal Equivalent Circuit

The measurements made on the test circuit by the system are as follows:

1. G(1) is measured at 1 MHz without the crystal being plugged into the socket.
2. Next G(2) is measured with the crystal inserted, but off resonance. The program first tries this measurement at 800 KHz, but moves off to a different frequency if the phase of G is significantly different from +90°.
3. Then, the series resonant frequency, defined as the point where the phase of G goes through 0° on its downward slope is found by an iterative search. G(3) is measured at this frequency.
4. Lastly, the slope SL(4) of the phase of G with respect to frequency at series resonance is determined by finding the frequency step necessary to cause approximately of 5° phase shift.

These measured results are used in the following set of approximate equations.

$$G(1) = \frac{R_T}{\sqrt{R_T^2 + X_{CS}^2}} \quad X_{CS} = \frac{1}{2\pi f C_s}$$

Is used to compute  $C_s$  = stray jig capacitance

$$G(2) = \frac{R_T}{\sqrt{R_T^2 + X_C^2}} \quad X_C = \frac{1}{2\pi f(C_o + C_s)}$$

Is used to compute  $C_o$

$$G(3) = \frac{R_T}{R_T + R_1}$$

Is used to compute  $R_1$

$$SL(4) = \frac{-2L_1}{R_T + R_1}$$

Is used to compute  $L_1$

$$f_s = \frac{1}{2\pi\sqrt{L_1 C_1}}$$

$f_s$  = series resonant frequency  
Is used to compute  $C_1$

$$f_A = f_s + \frac{f_s C_1}{2C_o}$$

$f_A$  = Parallel resonant frequency  
Is used to compute  $f_A$

$$Q = \frac{2 f_s L_1}{R_1}$$

Is used to compute Q

If the calculator is used to control the instruments and perform the mathematical manipulations, it can also print out the various computed quantities on its line printer:  $C_o$ ,  $L_1$ ,  $C_1$ ,  $R_1$ ,  $f_s$ ,  $f_A$ , Q.

The calculator program as written has two refinements not mentioned in the description above. The first is an iterative routine for making sure the measurements are made at the correct drive level. The user of the program specifies the drive level in microwatts, and the program begins with the synthesizer level set to a value which would drive the crystal at the specified power if the resistance  $R_1$  were equal to the 100  $\Omega$  test resistance. If  $R_1$  turns out to be larger or smaller, the actual power would be less. After measuring  $R_1$ , the program re-adjusts the synthesizer amplitude upward and repeats the search for resonance and the  $R_1$  measurement until the actual calculated power level is correct within the desired tolerance.

The other refinement is a method of measuring the insertion gain that essentially uses the relay in the test jig to "bootstrap" the accuracy of the measurement to the amplitude linearity of the synthesizer, which is better than  $\pm 0.05$  dB. Without the relay, the accuracy of the gain measurement would depend on the linearity of the analyzer which is  $\pm 0.5$  dB. This is done by measuring the response of the crystal with the relay switched open and storing the analyzer's reading. Then the switch is closed and the analyzer reading is forced to equal the stored reading by an iteration loop that programs the synthesizer's level. The level change needed from the synthesizer is equal to the insertion gain of the crystal in dB. Thus, measurements of crystal impedance with an accuracy of up to 0.5% are readily obtained.

An important thing to note about systems such as this one wherein the hardware is very general purpose and all procedures are in software, is that each user can adopt his own pet algorithms. Very few compromises have to be made in tailoring the parameter input, measurement method, and output format to the specific needs of the job at hand.



## Apply Your Ingenuity to Component Measurements

How many instruments do you need to measure the important parameters of such diverse components as capacitors, time delay lines and op amps? Instruments made to do these specific jobs are optimized for just a few measurements. To perform the full range of common measurements, either a complete collection of these instruments is needed or a single versatile instrument is needed. Instrument buyers are faced with the choice of optimizing for a specific measurement or optimizing for a wide range of measurements. The applications covered here use a single instrument to optimize for a wide range of measurements.

By using a little ingenuity, these measurements can be done with a minimum of equipment and, more significantly, a lower cost. One way to achieve these savings is to combine phase, gain and amplitude measuring functions into one instrument. This particular combination of functions is particularly useful for characterizing linear devices. A linear device can always be characterized by just looking at amplitude and phase at known frequencies. This statement comes from the fact that the output can always be represented

by  $A/B \sin(\omega t + \Theta)$  relative to an input of  $B \sin(\omega t)$ . Taking advantage of this relationship, many seemingly unrelated devices can be characterized with one instrument that measures gain and phase.

### Capacitors

Large capacitors at low frequencies are commonly modeled as a perfect capacitor in series with some resistance and inductance. The type of construction determines the values of these parameters for the specific capacitor. To measure some but not all of these parameters, a bridge of one type or another is usually used. Because these bridges are limited to a narrow range of frequencies, the range of measured values becomes limited. A bridge operating at 1 kHz will not portray the entire picture like the frequency response plot in Figure 16. It shows a tantalum capacitor which looks like a capacitor at low frequencies, but looks more like a resistor at 50 kHz, and an inductor above 100 kHz. This graphic display is a better way of showing its true characteristics over the frequency range used in some applications. All the information about capacitance,

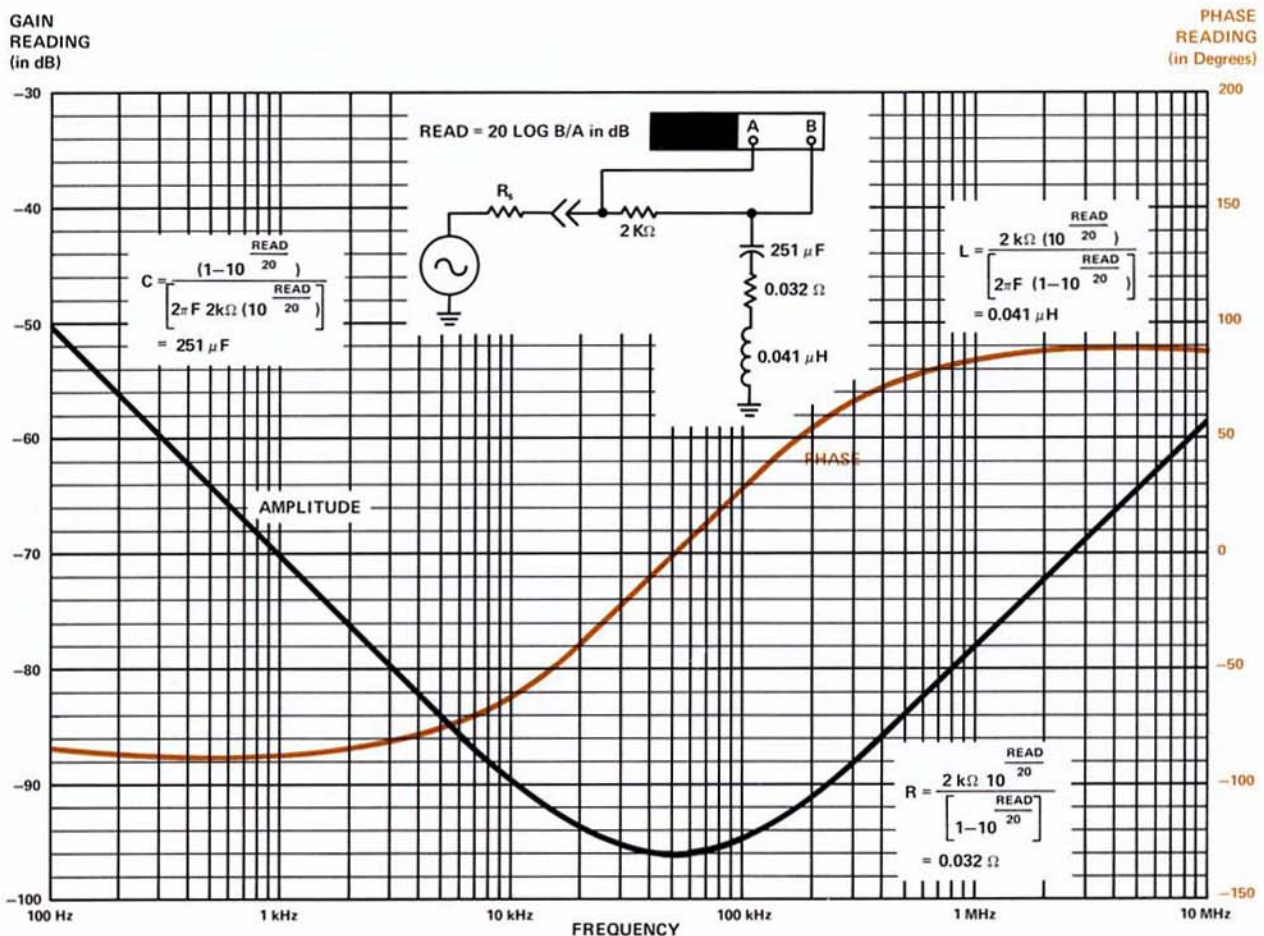

Figure 16. Frequency response plot

resistance and inductance can be found by using network analysis.

To find effective series resistance, vary the frequency until  $0^\circ$  phase is found. At this point, the gain reading, which is a function of effective series resistance, can be converted to ohms with the help of Figure 17. Because the instrument isn't optimized for this specific measurement, it isn't direct reading and the conversion is necessary. Charts are included to make the conversion easier. Decreasing the frequency by a factor of 10 or 20 puts the response curve into the capacitance

region. Gain readings can then be converted to capacitance values in farads. If the frequency were increased by a factor of 10 or 20, inductance could be found. Both capacitance and inductance-related gain readings can be converted to more familiar units using either Figure 18 or a calculator.

The effort used in conversion pays off when all three measurements are used. There is no single instrument that will display R, L and C for a device like this capacitor. Furthermore, the range in amplitude and frequency is not matched by any dedicated instrument.

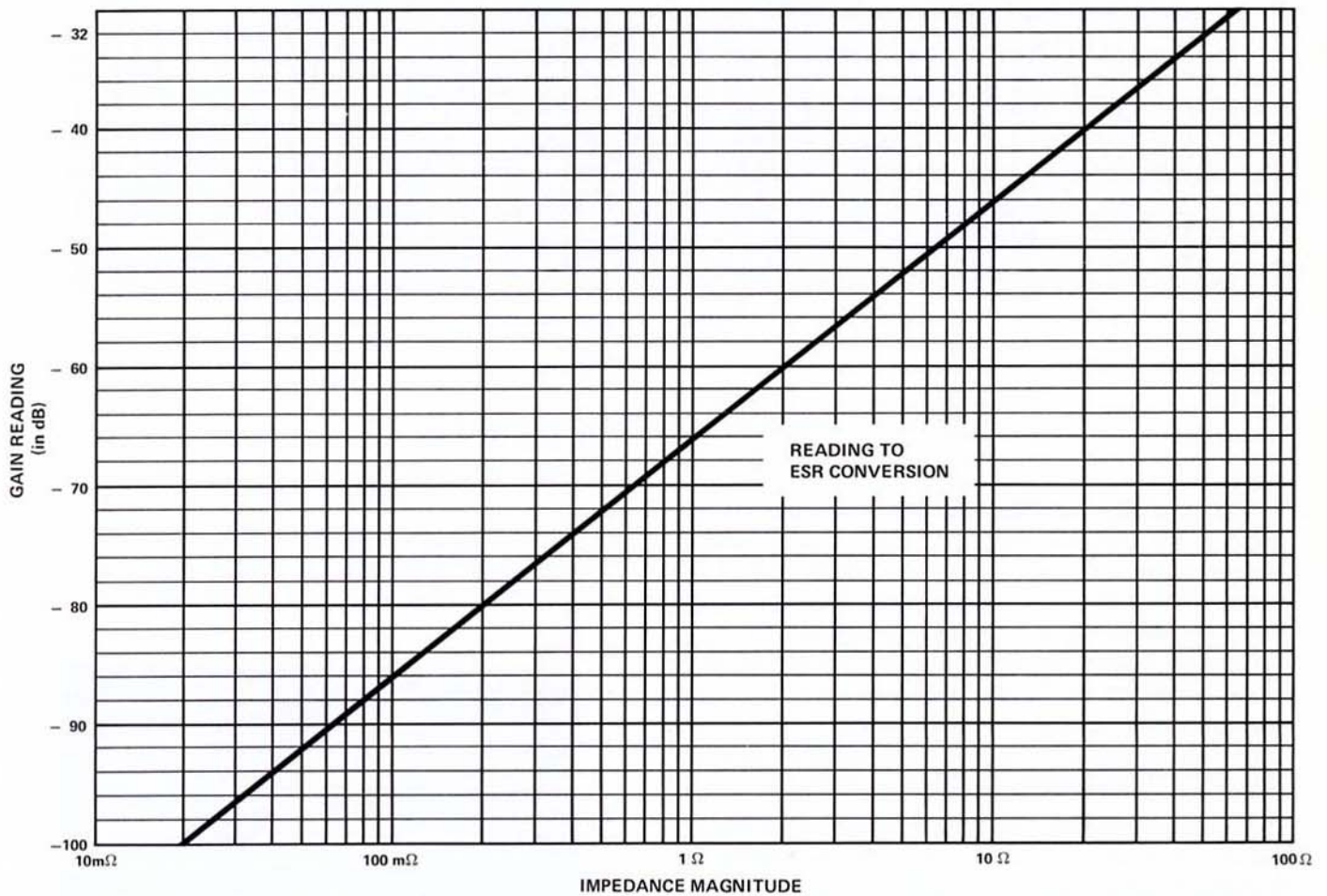

Figure 17. Reading to ESR conversion

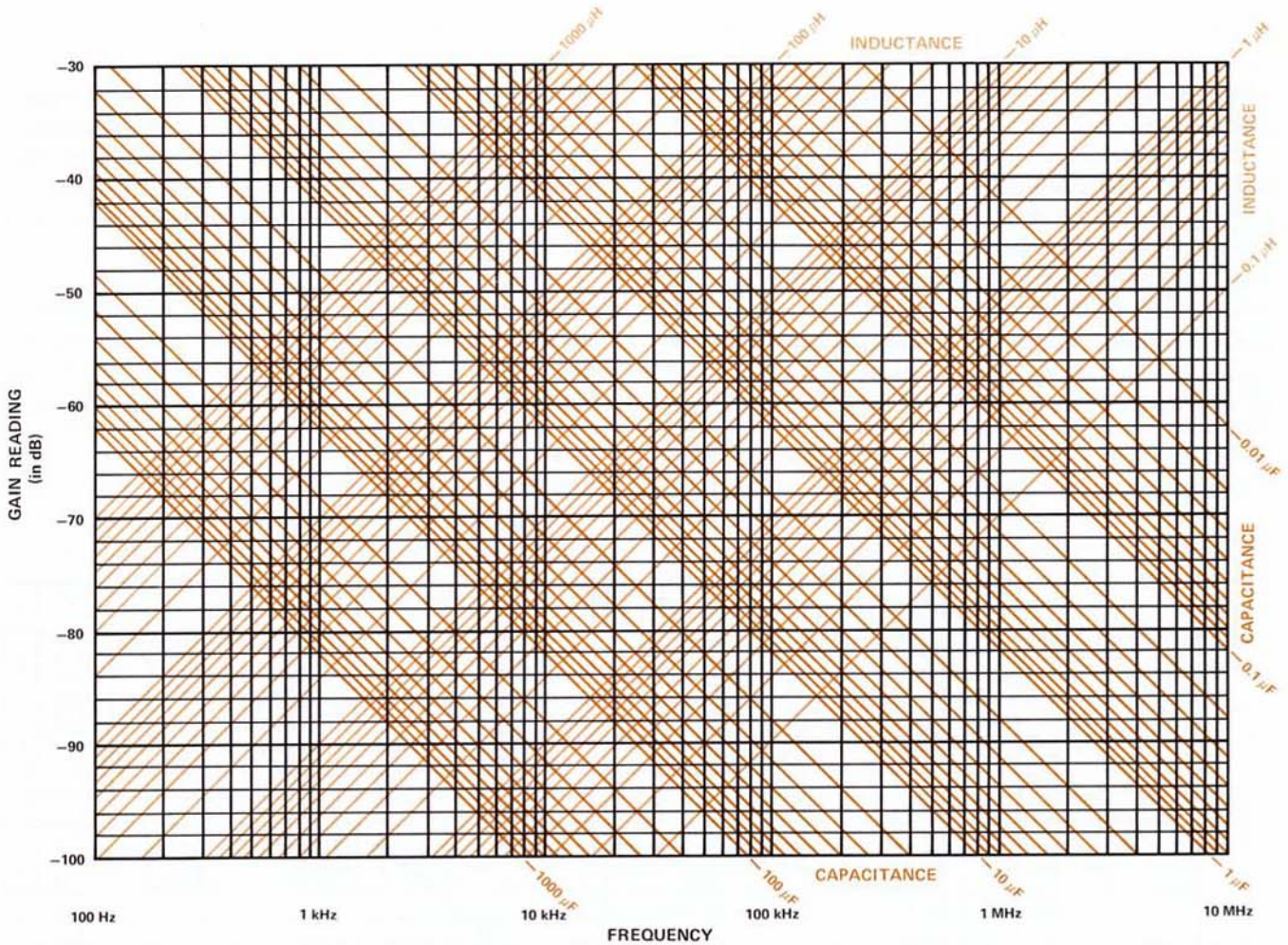

Figure 18. Capacitance/Inductance

### Delay Lines

The requirements for delay line measurements are quite a bit different from capacitor measurements. Ingenuity pays off because the gain phase meter can be used in both cases. Traditionally, these measurements are made with a counter or a scope. A time interval counter is useful for long time delays but the internal clock limits the resolution to 100 ns. This just isn't adequate to cover the delay line range from 5 ns to 6000 ns. For the same reason, a time interval counter also fails to measure delay between tap points.

A good scope can be used to look at short delays, but the lack of accuracy and difficulty of reading to high resolution make this a less than optimum technique.

As an alternative to counters and scopes, time delay can be thought of and measured as phase shift of a sine wave as shown in Figure 19. By picking an appropriate driving frequency, the reading in phase will correspond to time delay using a conversion that is no more complicated than a decimal point shift. A 277 kHz sine wave that is delayed by 100 ns will have a  $10^\circ$  phase shift.

$$\text{Delay} = \frac{1}{F \cdot 360}$$

Drive Frequency	Conversion
2.77 MHz	$1^\circ = 1 \text{ ns}$
277 kHz	$1^\circ = 10 \text{ ns}$
27.7 kHz	$1^\circ = 100 \text{ ns}$

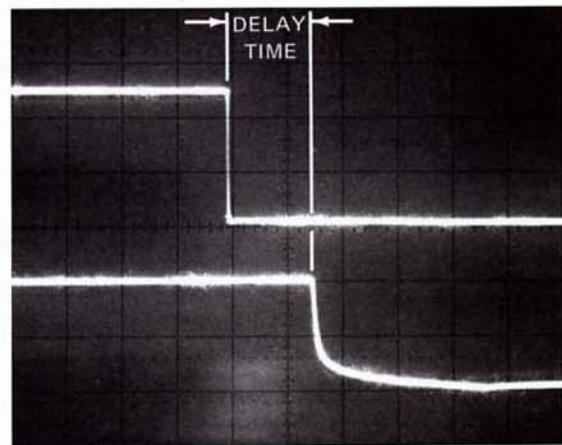

Figure 19. Measuring time delay of a delay line. The delay for this line is 37 ns.

The other characteristic of interest on delay lines is their loss. This isn't difficult to measure and it could be done in a variety of ways. Why not use the same instrument that is used to measure delay to also measure loss? A Gain Phase meter will do just that. The connections don't have to be changed to get both readings. The ability to find the ratio of the output to the input,

furthermore, removes the dependence on measuring the input level and output level separately to find loss through the delay line.

With this technique, it is easy to characterize a delay line and do it to accuracies good enough to find tap point and temperature variation characteristics.

### Op Amps/Rejection

Characterization of op amps present another opportunity for versatile measurements. To have complete understanding of the transient as well as steady state responses using the compensation schemes manufacturers suggest, amplitude and phase response plots have to be made. For the adventurous who want to extend the performance of op amps with their own compensation schemes, a response plot is also necessary. A broadband voltmeter and oscillator can be used to look at the amplitude response but that still leaves phase as an unknown. There are sweeping network analyzers for doing just this job. While they present a very nice display of the response, they are also expensive. By using a simple Gain Phase meter and plotting points yourself, a great cost savings can be realized without dedicating the instrument to a specific job.

While frequency response is important, it isn't the only parameter of interest. If the op amps didn't have common mode rejection or power supply rejection, they wouldn't be useful. The same instrument used for frequency response can be used for measuring rejection if it has a low enough frequency range to cover line frequencies and enough amplitude range to handle high gain amplifiers. While thinking about rejection measurements on op amps, consider the other opportunities for making a similar measurement. Figure 20 shows the typical hookups for rejection measurements in general. Note that in all these measurements, two instrument connections are made. These two connections are necessary for a true gain or loss measurement. The advantage of such a measurement is that readings are independent of the driving source flatness or loading as a function of frequency.

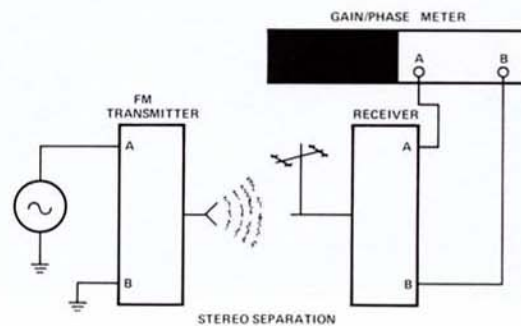
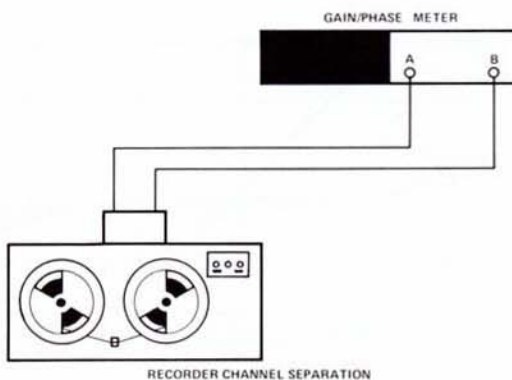
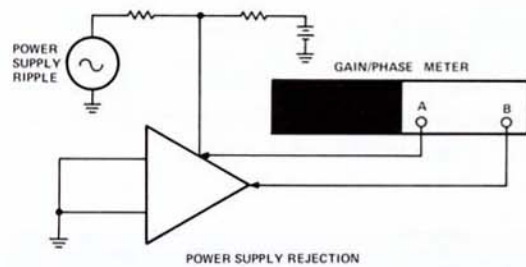
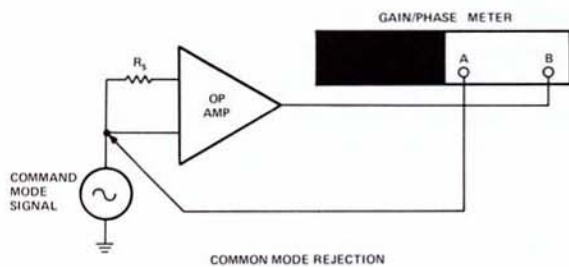

Figure 20. Typical hookups for general rejection measurements.

## Analyze Circuits with a Phase Meter That Also Measures Gain

Whether you're characterizing integrators and differentiators, measuring impedance or checking delay-line parameters, the phase method can come in handy.

How often have you bemoaned the shortcomings of your test equipment when attempting to solve a circuit problem? Perhaps your test equipment leaves something to be desired. However, before you get hung up on your test equipment, think about your measurement technique. In many cases, a change in technique can spare you the expense of buying better equipment, and as an additional bonus, give you valuable information that better equipment would not provide. A change in technique can be the key to solving many measurement problems at minimum cost. A few examples will illustrate how some traditional measurements can be improved and simplified by using a gain-phase meter; a meter that measures phase and amplitude or gain.

### Characterizing integrators and differentiators

The classical method for characterizing an integrator or differentiator is to apply a square-wave input to the circuit and monitor its response on an oscilloscope. This method has severe limitations where accuracy and resolution are required. The size of the oscilloscope face alone limits the resolution of a nonlinearity measurement to 5% and precludes high-accuracy measurements. The square-wave input can also introduce a slew-rate limitation in the circuit under test to produce high-frequency responses that mask low-frequency characteristics of interest.

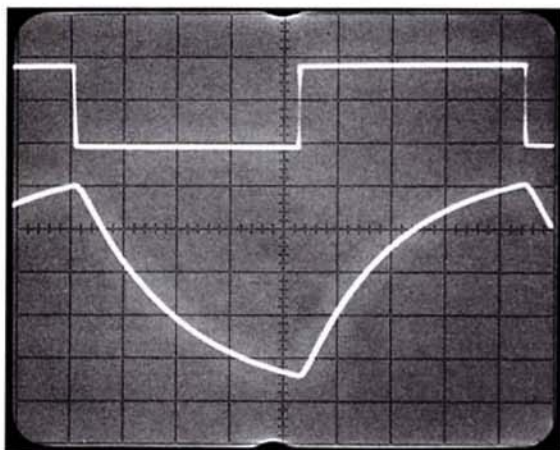

**Figure 21.** An integrator's response to a square wave input as seen on an oscilloscope (left). The same integrator's response to a sine-wave input can be plotted with a gain-

Since there is no such thing as a perfect integrator or differentiator due to physical limits on component values, part of your characterization should tell you how far an integrator or differentiator deviates from perfect performance. It should give a time-constant or a frequency to indicate low or high-frequency cutoffs.

Typically, oscilloscopes can indicate triangle-wave sags of roughly 20% below that of ideal linear traces. Sags of 1% could certainly not be quantified on an oscilloscope to evaluate a waveform for a time-constant or the location of a low-frequency pole. It is clear that the time-domain method of measurement is difficult for good accuracies. The answer is a simple change in technique. Phase measurements can add insight and the additional resolution needed for better measurements.

Theoretically, an integrator shifts a sine-wave input by  $-90$  degrees while a differentiator shifts the same input by  $+90$  degrees. By making a phase measurement, deviations from the theoretical phase-response curve can be easily investigated without calculations of slopes and linearity from oscilloscope measurements.

Another advantage of the phase technique over an oscilloscope is that the latter cannot distinguish between the source of high frequency problems in an integrator. (Is the problem in the integrator itself or is it from the signal source?) Phase measurement eliminates source errors and exposes only integrator problems.

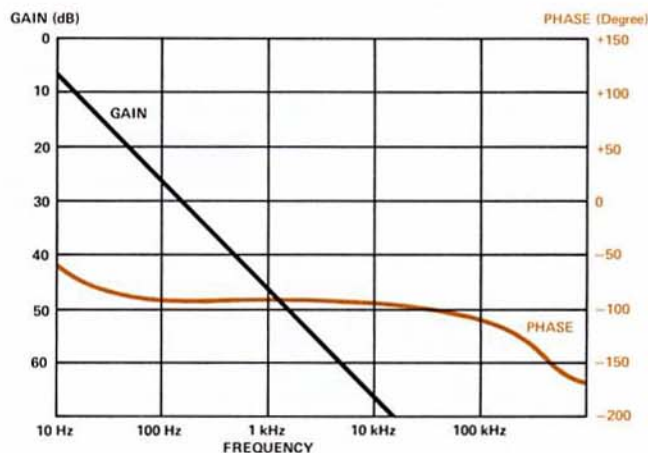

phase meter (right). This latter method shows how much easier it is to look for integrator deviations in phase shift than it is by using an oscilloscope.

Figure 21 (right) shows the gain and phase response of an integrator to a sine-wave input. At the low-frequency end, phase is not ideally  $-90$  degrees and the amplitude curve is not rolling off by  $6$  dB/octave. The oscilloscope trace in Fig. 21 (left) is the same integrator's response to a square-wave input. Using it to measure the slope to find deviations from the theoretical amplitude response is obviously quite difficult. Two points have to be looked at and calculations are required. The phase method as shown in the response curve is obviously much easier.

For general applications, the response curve allows integrator characterization at a frequency range where phase is within  $5$  degrees of  $-90$  degrees. Alternatively, the frequency of the integrator pole can be found easily with a single phase measurement. For example, a phase reading of  $-84.3$  degrees automatically tells us that the integrator's stimulation frequency is ten times its pole frequency. At a phase reading of  $-87.1$  degrees, the pole frequency is  $1/20$ th that of the stimulating frequency.

### Impedance measurements

Traditional impedance-measuring instruments cannot always accurately measure complex and active-device impedances. Multimeters cannot measure the impedance of active components with dc bias or

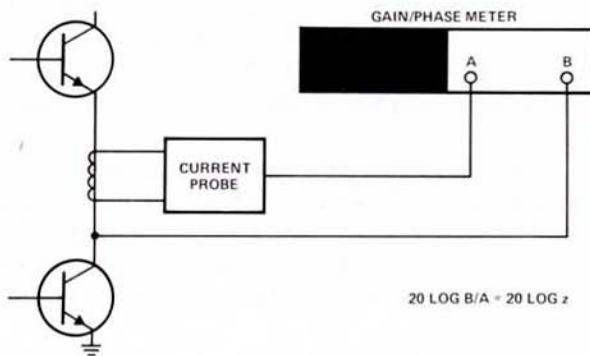
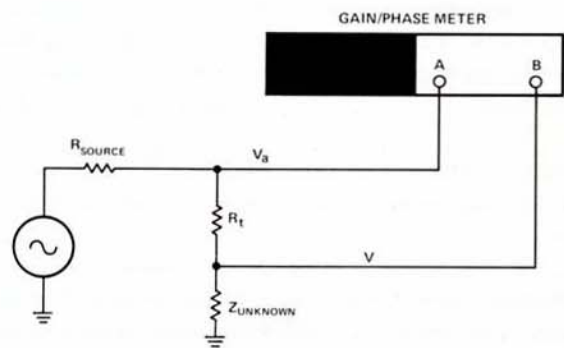

**Figure 22.** A gain-phase meter can simplify impedance measurements. Here a current probe converts current to voltage, allowing the meter to read a circuit's complex impedance by the use of the relationship  $20 \log B/A = 20 \log Z$ . The advantage of this setup is that the measurement is independent of any source variations allowing in-circuit measurements.

amplifier input impedance. A vector impedance meter solves the dc bias problem by making an ac measurement and blocking the dc. It also solves the problem of making complex measurements at different frequencies. Because the measurement is tied to the internal oscillator of the impedance meter, it is not possible to accurately measure impedances inside such working circuits as oscillators. It is all too easy for the circuit under test to induce disturbing harmonics into the impedance meter. Here again, a phase-measurement technique can solve this problem (Fig. 22).

Low-impedance measurements bring out another shortcoming of conventional impedance meters. For example, it is difficult to measure the  $20\text{-m}\Omega$  impedance of a ground bus using a conventional impedance meter with a  $1\ \Omega$  fullscale range. This type of measurement can be made, however, with a gain-phase meter, as shown in Fig. 23.

As long as  $R_t$  is much larger than the unknown impedance, voltage  $V_a$  will be directly proportional to the constant current flowing through the unknown resistance and voltage  $V$  will vary with the unknown impedance. The voltage ratio of  $V$  to  $V_a$  will be proportional to the complex impedance. With  $R_t = 50\ \Omega$ , a gain reading of  $-60$  dB on the meter corresponds to  $50\ \text{m}\Omega$ , and that of  $-80$  dB to  $5\ \text{m}\Omega$ . All that is needed for calculation is the value of  $R_t$ .



**Figure 23.** Low impedance can be measured with a gain-phase meter using this setup. As long as  $R_t$  is much larger than the unknown impedance, voltage  $V_a$  will be directly proportional to the constant current flowing through the unknown resistance and voltage  $V$  will vary with unknown impedance. The ratio of  $V$  to  $V_a$  will be proportional to the complex impedance.



**Figure 24.** Hewlett-Packard Model 3575A GAIN-PHASE METER is the first such unit with LED digital display to operate without requiring user tuning. Its operating frequency range is from 1 Hz to 13 MHz, and the dynamic amplitude span covered is 80 dB.

## Digital-Readout Gain-Phase Meter Spans 1 Hz to 13 MHz

### *Progress in Gain-Phase Meters*

Basically this new instrument provides a better way to make simultaneous gain and phase measurements at audio and low RF frequencies. It does so without frequency tuning or amplitude setting—and covers a wider frequency range than its competitors.

Several features of the 3575A are of considerable importance to a user. One such feature is its unique correction scheme to reduce noise-caused errors. This eliminates errors caused by noise in some situations. In other cases, it both makes the error smaller and causes them to increase less abruptly with an increase in the noise level.

**Effects of noise.** Most phase meters are subject to three types of noise-caused problems: Ambiguity, jitter and offset.

Ambiguity is the condition where readings are impossible because the input to the readout fluctuates wildly. This results in a bouncing analog meter reading,

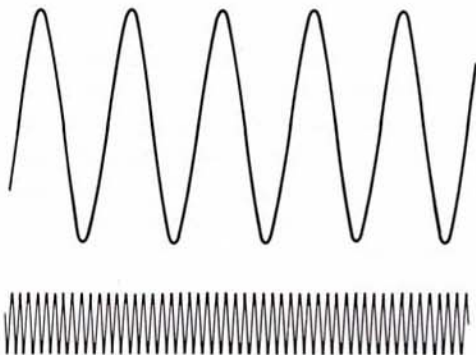

**Figure 25.** Versatility of the gain-phase meter is well-illustrated by its ratio-measuring capabilities. It can measure, in dB, the log ratio of two signals. Furthermore, these signals need not be of the same frequency, which increases the instrument's usefulness.

or a digital one in which all digits are constantly changing. It is this type of error that has been eliminated in the 3575A for any level. (Some competitive units require that noise be from 50 to 70 dB below the signal if they are to read correctly, and with greater noise input they can—and do—read 180° in error.)

Jitter caused by noise is handled in the usual way by filtering. Of course, the sample rate decreases as the amount of filtering is increased.

Offset effects from noise are a result of prefiltering in the zero-crossing circuits. Band-limiting filtering will reduce offset errors, but the H-P scheme for minimizing the ambiguity problem is also quite effective against the offset error.

A direct comparison of measuring ability will show that both the 3575A and competitive units usually are free of noise-caused reading errors if the noise level is 60 dB down. At 40 dB down, some competitive units are already in trouble, but the 3575A will have only about 1° error.

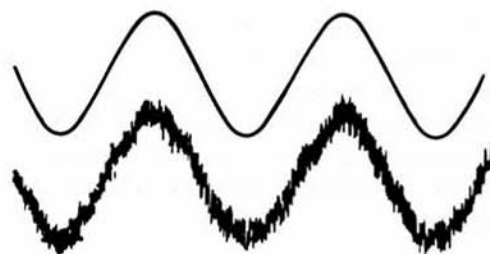

**Figure 26.** Phase measurements of noisy signals are readily made with the new 3575A Gain-Phase Meter. Even the high-frequency noise present on the lower trace does not preclude a useful phase measurement, for it only results in a phase offset of 2.5° and the measurement is free of jitter or bobble in the readout.

### Key specs of the 3575A

- Its 1 Hz to 13 MHz range is considerably greater than that covered by other similar instruments. Phase accuracy is specified as  $\pm 0.5^\circ$  from 1 Hz to 20kHz and phase resolution is  $0.1^\circ$ .
- Its dynamic amplitude span is 80 dB, permitting ranges of 200  $\mu\text{V}$  to 2V, 2 mV to 20V and (with divider probe) 20 mV to 200V. Amplitude accuracy is  $\pm 1$  dB from 1 Hz to 1 MHz, with 0.1 dB resolution.

### Automatic Network Analyzer Uses Calculator for Control and Data Analysis

Traditionally, network analysis has been done in one of two ways...either by manually controlled instruments or totally automatic computer-controlled instrumentation with great complexity and expense.

Now a new automatic network analyzer is available with the same capability as computer-controlled systems but at a much lower price. This network analyzer also brings the automatic data analysis capability of the computer system to the design engineer at a price often paid for the manual equipment alone.

Stimulus response measurements of amplitude, phase, and group delay can be made more accurately and conveniently than ever before. Programmable calculator control of a new Automatic Synthesizer and tracking detector provide greater accuracy and measurement range as well as providing data analysis capability.

### Stimulus Response Measurements

Stimulus response measurements of linear networks are made by this analyzer utilizing the 3330B Automatic Synthesizer as a source, and the 3570A as a tracking detector.

Amplitude measurements can be made over a frequency range of 50 Hz to 13 MHz, and over a dynamic range of 100 dB. The frequency and amplitude resolution of the source are 0.1 Hz and 0.01 dB respectively. The amplitude measurement of the detector

- Its digital readout uses light-emitting diodes for a crisp, compact display.
- It provides Log B/A, or dBV A or dBV B (reference 1 volt).
- It has automatic internal ranging about  $0^\circ$ .
- Overload indication is included.
- The option choice is wide, and includes either one- or two-DPM units; the same plus programming; or units without DPM.

is displayed in a 4 digit LED display to 0.01 dB resolution. HP's 3570A is a two-channel detector; amplitude measurements can be made of the Reference, Test Channel, or the difference between the two. These frequency selective amplitude measurements can be made with bandwidths of 10 Hz, 100 Hz, or 3 kHz.

The phase of the test channel, with respect to the reference channel is displayed by the tracking detector over a range of  $\pm 180^\circ$  to a resolution of  $0.01^\circ$ . The 3570A can optionally make group delay measurements by utilizing the phase readings to internally perform calculations on the group delay formula.

$$\tau_g = \frac{\phi_1 - \phi_2}{360 (f_2 - f_1)}$$

When in the optional delay mode, the 3570A indicates group delay in the phase display over five ranges from 20  $\mu\text{s}$  to 200 ms with a sensitivity of 1 ns to 10  $\mu\text{s}$ . Twenty choices of split frequencies are available for selecting frequency resolution of the delay measurements. These delay measurements can be either single point...that is, at any specific frequency...or can be swept over an entire frequency band of interest. In the standard 3042A Network Analyzer, the calculator performs these group delay calculations using the phase readings.

Analog outputs of the amplitude and phase readings are available for display of these parameters on an x-y recorder or oscilloscope.

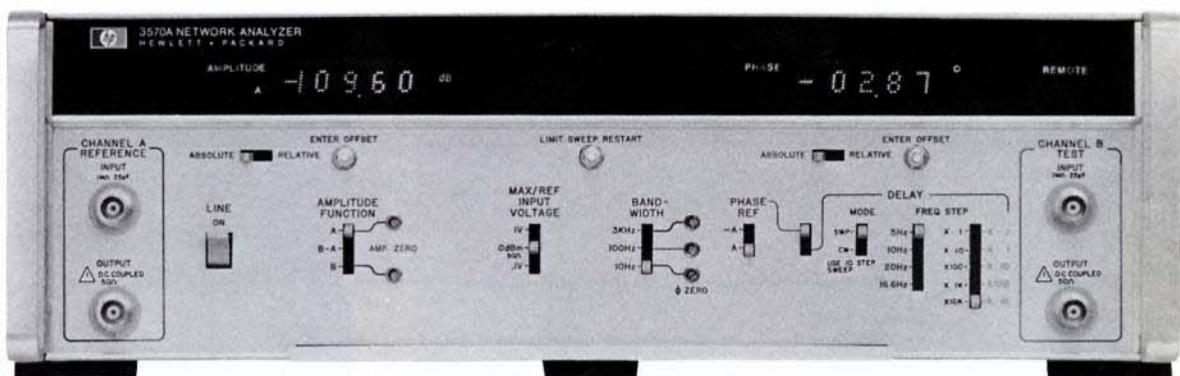

Figure 27. Hewlett-Packard Model 3570A Network Analyzer used with the 3320A/B or the 3330A has a frequency range from 50 Hz to 13 MHz and 100 dB of dynamic range.



## INSTRUMENT ALTERNATIVES

This is a representative list representing the most common configurations. Other instruments could be used to satisfy the needs of specific applications.

APPROXIMATE PRICE

FREQUENCY CONTROL

INSTRUMENT CONTROL

FREQUENCY

ACCURACY/RESOLUTION

DISPLAY OF READING

### EQUIPMENT LIST

This comparison chart shows the different configurations of instruments that can be assembled for different application requirements. Options can be added to extend the capability of these basis configurations.

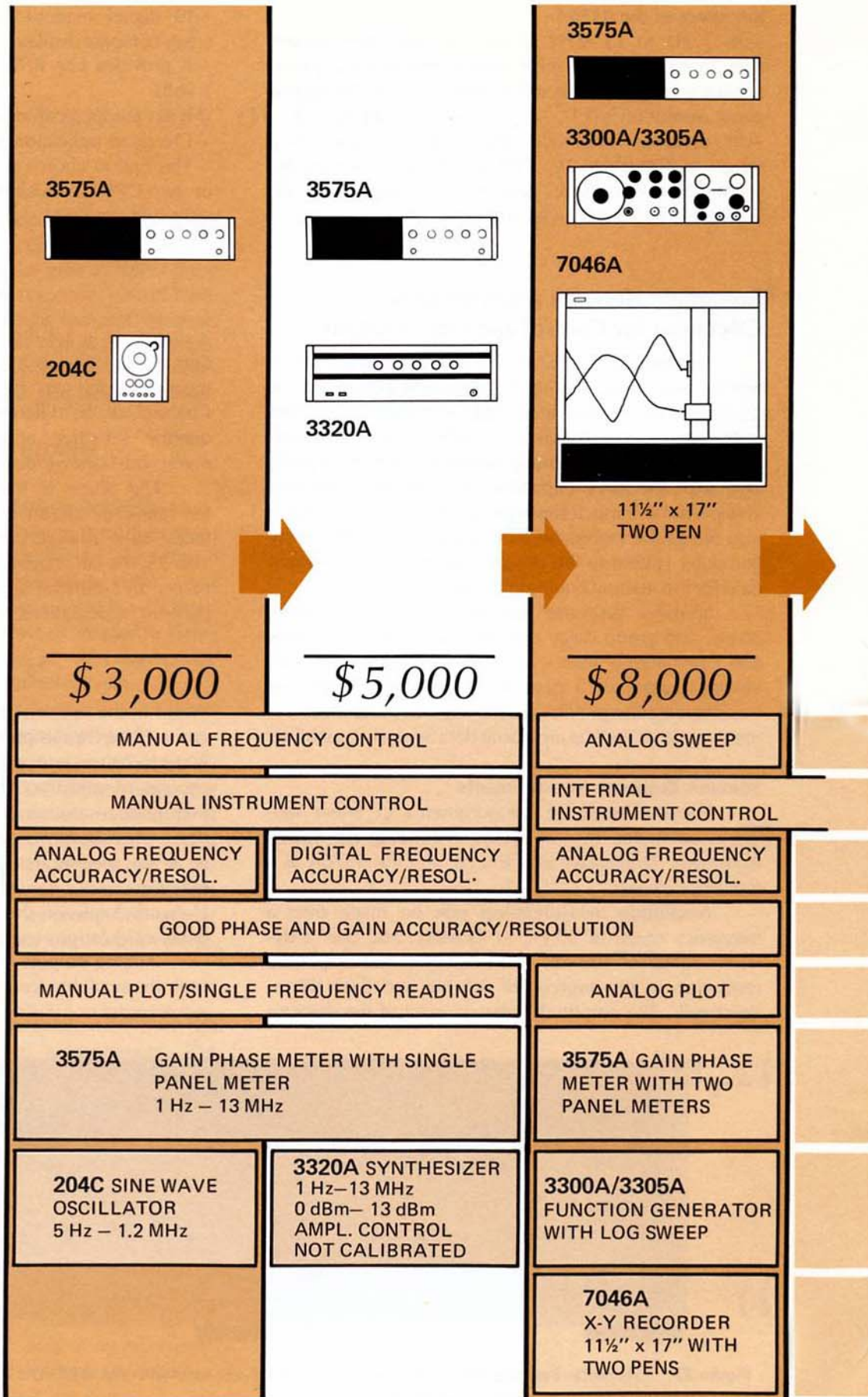
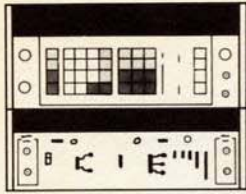
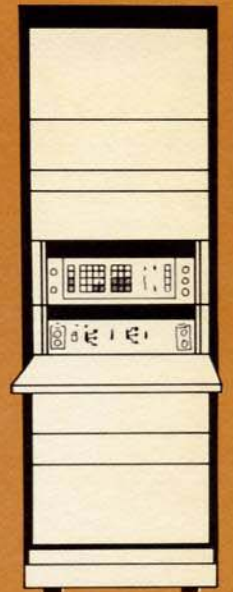
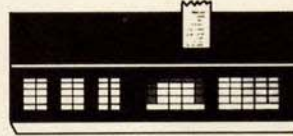
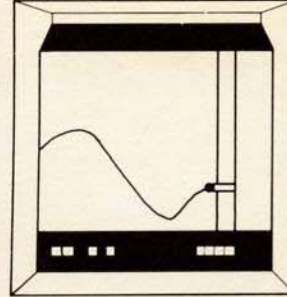
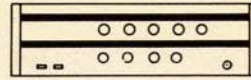

Figure 28. Instrument Selection Chart

3330B



3570A



3040A  
\$12,000

3041A  
\$15,000

3043A  
\$18,000

9820A  
3042A  
\$26,000

DIGITAL SWEEP

DIGITAL SWEEP

INTERNAL INSTRUMENT CONTROL

SEMI-AUTO CONTROL

AUTOMATIC CALCULATOR CONTROL

DIGITAL FREQUENCY ACCURACY/RESOLUTION

BEST PHASE AND GAIN ACCURACY/RESOLUTION

GOOD PHASE & GAIN ACCURACY/RESOL.

BEST PHASE & GAIN ACCURACY/RESOL.

LIMIT TEST CAPABILITY

DIGITAL PLOT

3570A NETWORK ANALYZER  
50 Hz - 13 MHz

3575A GAIN PHASE METER  
PROGRAMMABLE

3570A NETWORK ANALYZER WITH  
ASCII CONTROL

3330B SYNTHESIZER WITH LINEAR AMPLITUDE  
OR FREQUENCY SWEEP

3320B SYNTHESIZER WITH ASCII CONTROL  
+26.99 dBm to -69.99 dBm

3330B SYNTHESIZER WITH ASCII CONTROL

3260A CARD READER  
MARKED CARD CONTR OF INSTRUMENTS

9862A PLOTTER WITH DIGITAL PLOTS  
11 1/2" x 17"

9820A CALCULATOR CONTROL OF INSTRUMENT  
AND DATA MANIPULATION



For more information, call your local HP Sales Office or East (201) 265-5000 • Midwest (312) 677-0400 • South (404) 436-6181 • West (213) 877-1282. Or write: Hewlett-Packard, 1501 Page Mill Road, Palo Alto, CA 94304. In Europe: P.O. Box 85, CH-1217 Meyrin 2, Geneva, Switzerland. In Japan: YHP, 1-59-1, Yoyogi, Shibuya-Ku, Tokyo, 151.