

REVISION RECORD		APPROVED:	DATE:
LTR	ECD NO:		

1

2

3

4

5

6

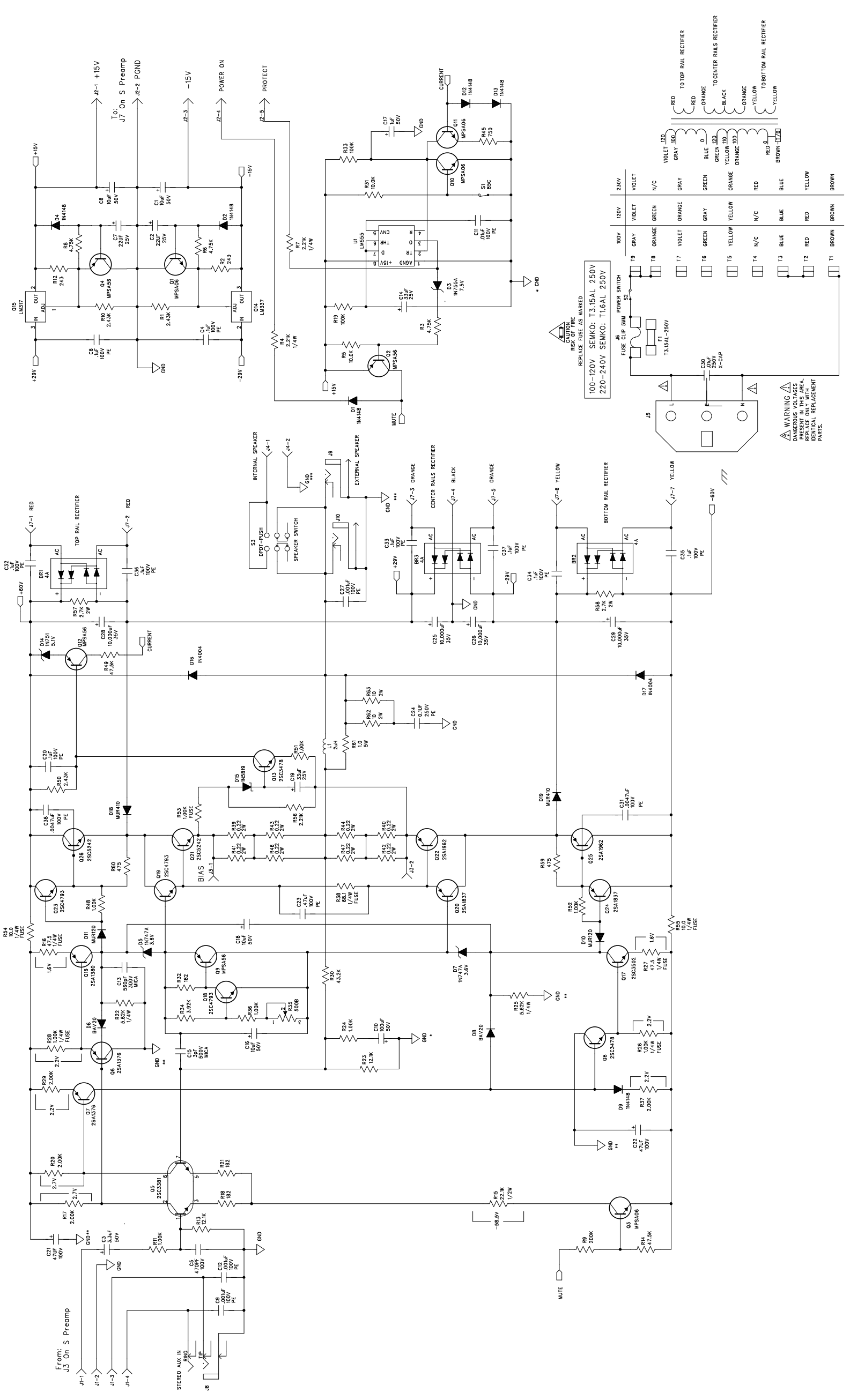

NOT VALID UNLESS STAMP IS RED

BIAS ADJUSTMENT PROCEDURE
 WITH POWER OFF, ADJUST POT R35 TO FULL COUNTER-CLOCKWISE POSITION.
 TURN ON POWER AND WAIT 5 SECONDS FOR TURN ON DELAY.
 TURN R35 CLOCKWISE UNTIL VOLTAGE ACROSS J3 READS TO mVDC.

WARNING
 DANGEROUS VOLTAGES
 REPLACE ONLY WITH
 IDENTICAL REPLACEMENT
 PARTS.

gallien technology

2240 PARAGON DRIVE SAN JOSE CA. 95131 VOICE: 408-441-8081 FAX: 408-441-8085		TITLE: MB150-III POWER AMP	
DESIGNED: R.A.G.	DATE: 2/28/01	DRAWING NO: 406-0211-A	REV: A
DRAWN: R.A.G.	DATE: 12/25/02	PART NO: 206-0211-A	
ELEC: R.A.G.		COMPANY: GALLIEN-KRUEGER	
MECH:		Q/A:	
RELEASED:		FILENAME: 6211A.sch	

1. CHANGE R48 TO 1K AND R32 TO 10K.
2. CHANGE R83 TO FUSE RESISTOR.
3. DELETE C23 AND Q24 SUPPLY BYPASS CAPS.
4. ADD .47UF ACROSS R38.
5. UPDATE ALL HOLE AND PAD SIZES.
6. MOVE D18 CLOSER TO Q28.
7. UPDATE BOARD NO. TO 206-0211-A.
8. UPDATE BOARD NO. TO 206-0211-A.
9. ADD OUTPUT FILTER.

X1

GK GALLIEN-KRUEGER

MB150-III Power Amp		Bill Of Material	206-021 1-A	
Part No.	Reference	Description	Manufacturer	Mfr. Part No.
001-2060-0	U1	LM555, TIMER	NATIONAL	LM555CN
010-0000-0	Q5	2SC3381BL,NPNX2,80V,100MA,2-10M1B	TOSHIBA	2SC3281BL
010-0001-0	Q8 Q13	2SC3478, NPN,180V,100MA,TO-92	NEC	2SC3478-K
010-0003-0	Q17	2SC3502-F,NPN,200V,100MA,TO-126	TOSHIBA	2SC3502
010-0012-0	Q1 Q3 Q10-11	MPSAO6, NPN,80V,500MA,TO-92	MOTOROLA	MPS-A06
010-1002-0	Q6-7	2SA1376, PNP,180V,100MA,TO-92	NEC	2SA1376-K
010-1003-0	Q16	2SA1380-F,PNP,200V,100MA,TO-126	SANYO/TOSHIBA	2SA1380-F/E
010-1013-0	Q2 Q4 Q9 Q12	MPSA56 PNP 80V 500MA TO-92	MOTOROLA	MPS-A56
012-0002-0	Q18-19 Q23	2SC4793,NPN,200V,1.5A,2-10R1A	TOSHIBA	2SC4793
012-0003-0	Q21 Q26	2SC5242,NPN,230V,15A,2-16C1A	TOSHIBA	2SC5242-O
012-1002-0	Q20 Q24	2SA1837,PNP,200V,1.5A,2-10R1A	TOSHIBA	2SA1837
012-1003-0	Q22 Q25	2SA1962,PNP,230V,15A,2-16C1A	TOSHIBA	2SA1962
014-0070-0	Q15	LM317	NATIONAL	LM317
014-1072-0	Q14	LM337	NATIONAL	LM337
020-0004-0	D3	1N755A, ZENER,7.5V,500MW ,D035	TAITRON	1N755A
020-0036-0	D5 D7	1N747A, ZENER, 3.6V, 5%, 400MW, DO-35	TAITRON	1N747A
020-0050-0	D14	1N751, ZENER,5.1V,10%,400MW,DO-35	NATIONAL	1N751
020-1000-0	D1-2 D4 D9 D12-13	1N4148, RECT-FAST, 200MA, 100V	MOTOROLA	1N4148
020-1022-0	D6 D8	BAV20, RECT, 200V, DO-35	NATIONAL	BAV20
020-1104-0	D15	SHOTTKY, 1A, 40V, 10NS, DO-41	MOTOROLA	1N5819
020-1120-0	D10-11	MUR120,RECT-FAST, 1A, 200V, 25NS, 59-04	MOTOROLA	MUR120
020-1122-0	D18-19	MUR410, RECT-FAST, 4A, 100V	MOTOROLA	MUR410
020-2106-0	D16-17	1N4004,RECT,1A,400V,DO-41	TAITRON	1N4004
023-0005-0	BR1-3	BRIDGE, 4A, 100V, VERT, PC	TAITRON	TU401
031-1226-0	C2 C7	CAP,ELEC,RAD,226, 20%,25V	UNITED CHEMI-CON	SRG25VB22RM5X7LL
031-1336-0	C14 C19	CAP,ELEC,RAD,336,20%,25V	UNITED CHEMI-CON	SRG25VB33RM5X7LL
031-2105-0	C17	CAP,ELEC,RAD, 105, 20%, 50V	UNITED CHEMI-CON	C440C105M5U5CA
031-2106-0	C1 C8 C16 C18	CAP,ELEC,RAD, 106, 20%, 50V	UNITED CHEMI-CON	SMG50VB10RM5X11LL
031-2107-0	C10	CAP,ELEC,RAD,107, 20%, 50V	UNITED CHEMI-CON	SMG50VB101M8X11LL
031-2109-1	C25-26 C28-29	CAP, ELEC, RAD, 10,000uF, -10% +50%, 35V	UNITED CHEMICON	SMH35VN103M30x30T2
031-2335-0	C3	CAP,ELEC,RAD,335,20%,50V	UNITED CHEMI-CON	SMG50VB3R3M5X11LL
031-4476-0	C21-22	CAP,ELEC,RAD,476,-10%+50%,100V	UNITED CHEMI-CON	SMG100VB47RM10X12LL
032-4102-0	C9 C12 C27	CAP,PE,102,5%,100V,	PANASONIC	ECQB1102JF
032-4103-0	C11	CAP,PE,103,5%,100V,	PANASONIC	ECQV1103JM
032-4104-0	C4 C6 C20 C32-37	CAP,PE,104,5%,100V,	PANASONIC	ECQV1104JM
032-4472-0	C31 C38	CAP,PE,472,5%,100V,	PANASONIC	ECQB1472JF
032-4474-0	C23	CAP,PE,474,5%,100V,	PANASONIC	ECQV1474JM
032-7104-0	C24	CAP,PE,104,10%, 250V	ILLINOIS CAPACITOR	104MSR250K
034-4471-0	C5	CAP,MCR,470pF,5%,100V,	TAITRON	TMRS471J100NPOB
034-7103-0	C30	CAP, CERMIC DISK, 103, 10%, X-250V	PANASONIC	ECK-DRS103ZV
035-8030-0	C15	CAP MICA AXIAL , 3pF, 10%, 500V	CORNELL	CD10CD030D03
035-8561-0	C13	CAP MICA RADIAL, 561, 5%, 300V	CORNELL	CD15FC561J103
052-2212-0	R4 R7	RES,METAL FILM,2.21k,1/4W,1%	ECI	M2F1AK002.21
052-5622-0	R22 R25	RES,METAL FILM,5.62K,1/4W,1%	ECI	M5F1AK005.62
055-.220-0	R39-44 R46-47	RES, METAL OXIDE, 0.22 Ohm, 2W, 5%	ECI	MOM20J3AJ000.22
055-0101-0	R62-63	RES, METAL OXIDE, 10 OHM, 2W, 5%	ECI	MOM20J3AJ010.00
055-2702-0	R57-58	RES, METAL OXIDE, 2.7K OHM, 2W, 5%	ECI	MOM20J3AK002.70
056-0100-0	R61	RES, CERAMIC WW, 1.0, 5W, 10%	ECI	WWC50J3AJ001.00
059-1000-0	R54-55	RES,MF,FUSE,10.0 OHM, 1/4W,1%	JUKN.OHM	FR25-10.0
059-1002-0	R26 R28	RES,MF,FUSE,1.00K,1/4W,1%	JUKN.OHM	FR25-1.00K
059-1002-0	R53	RES,MF,FUSE, 1.00K, 1/4W, 1%	JUKN.OHM	FR25-1.00K
059-4750-0	R16 R27	RES,MF,FUSE,47.5 OHM, 1/4W,1%	JUKN.OHM	FR25-47.5
059-6810-0	R38	RES,MF,FUSE,68.1 OHM, 1/4W,1%	JUKN.OHM	FR25-68.1
060-1002-0	R11 R24 R36 R48 R51-52	RES,METAL FILM, 1.00K, 1/8W, 1%	ECI	M1F1AK001.00
060-1003-0	R5 R31	RES,METAL FILM, 10.0K, 1/8W,1%	ECI	M1F1AK010.00
060-1004-0	R19 R33	RES,METAL FILM, 100K, 1/8W, 1%	ECI	M1F1AK100.00
060-1213-0	R13 R23	RES,METAL FILM, 12.1K OHM, 1/8W, 1%	ECI	M1F1AK012.10
060-1821-0	R18 R21 R32	RES,METAL FILM, 182, 1/8W, 1%	ECI	M1F1AJ182.00
060-2002-0	R17 R20 R29 R37	RES,METAL FILM, 2.00K, 1/8W, 1%	ECI	M1F1AK002.00
060-2004-0	R9	RES,METAL FILM, 200K, 1/8W, 1%	ECI	M1F1AK200.00
060-2212-0	R56	RES,METAL FILM, 2.21K, 1/8W, 1%	ECI	M1F1AK002.21
060-2431-0	R2 R12	RES,METAL FILM, 243 Ohm, 1/8W, 1%	ECI	M1F1AJ243.00
060-2432-0	R1 R10 R50	RES,METAL FILM, 2.43K, 1/8W, 1%	ECI	M1F1AK002.43
060-3922-0	R34	RES,METAL FILM, 3.92K, 1/8W, 1%	ECI	M1F1AK003.92
060-4323-0	R30	RES,METAL FILM, 43.2K, 1/8W, 1%	ECI	M1F1AK043.20

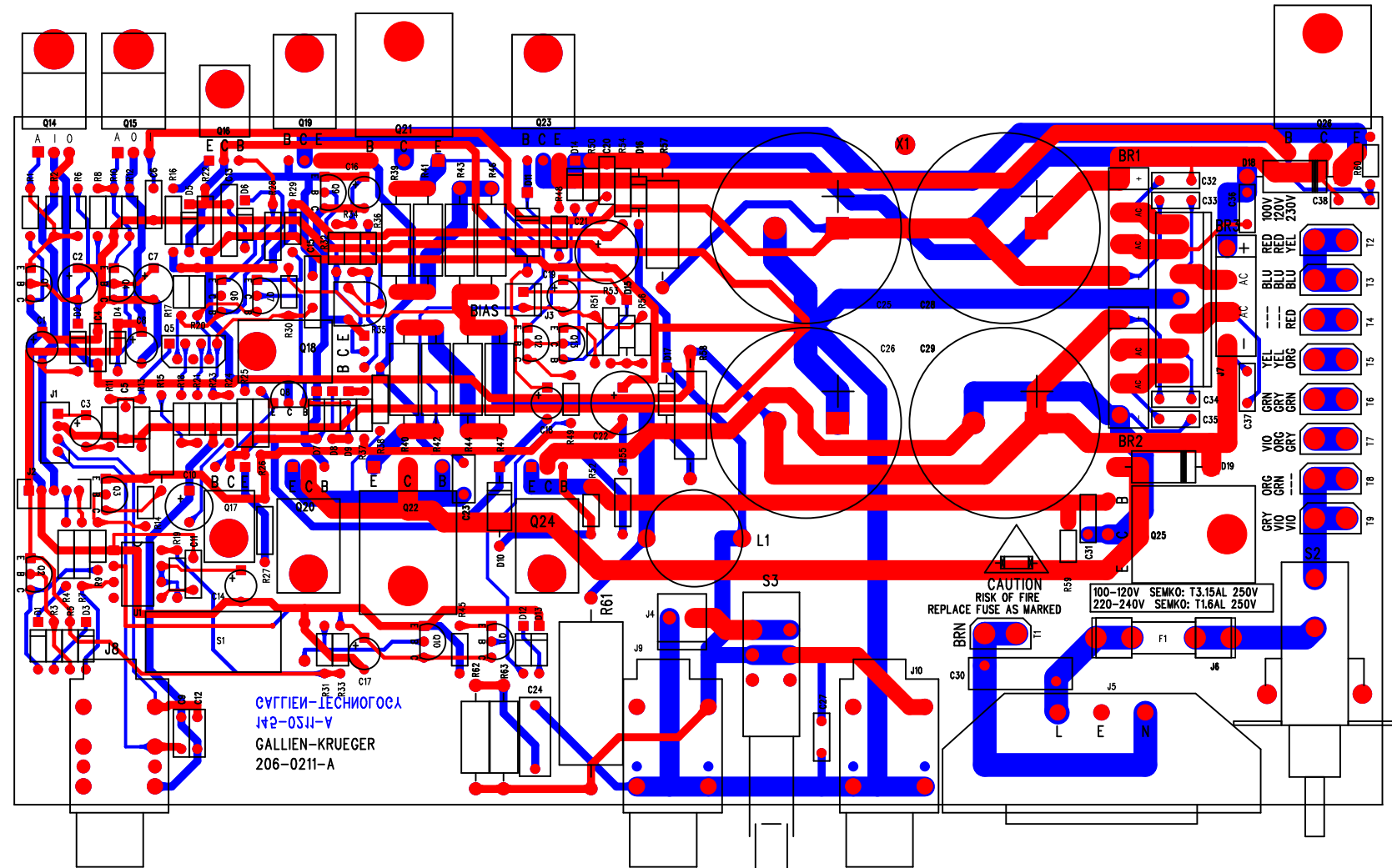

PCB WORK INSTRUCTIONS

DWG 420-0211-A

NOTES:

UNLESS OTHERWISE SPECIFIED:

1. SQUARE PADS ON THRU HOLE PARTS (ie: CONNECTORS, DIPS, SIPS, LEDS) DENOTE PIN 1.
2. ALL BOARDS REQUIRE A COMPLETE AND THOROUGH VISUAL INSPECTION.
3. ALL BOARDS MUST BE BARE BOARD TESTED.
4. ASSEMBLE AND SOLDER PER ANSI/IPC-A-610B.

LOADING

5. LOAD POWER TRANSISTORS AS INSTRUCTED BELOW AFTER WAVE.
USE A JIG TO POSITION MOUNTING HOLES CORRECTLY.
MOUNT ON BACK SIDE OF BOARD WITH PART NUMBER SIDE
FACING BOTTOM OF BOARD AND THERMAL CONDUCTING SIDE FACING DOWN.

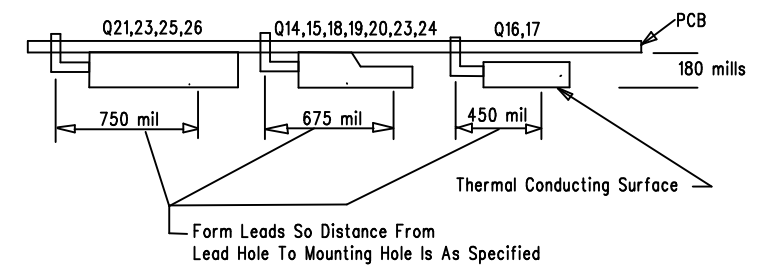

6. MOUNT S1 TO BOTTOM OF BOARD AFTER WAVE AS SHOWN.



7. FUSE LOADING - F1

FOR 100V & 120V MODEL:
LOAD FUSE, 5MM, T3.15AL 250V SEMKO

FOR 230V MODEL:
LOAD FUSE, 5MM, T1.6AL 250V SEMKO

FINAL QA

8. CHECK THAT J1,2,3,4,5,6 & 7 ARE FLUSH WITH PCB AND STRAIGHT.
9. GLUE C30 TO J5 WITH SILICON RTV

NOT VALID UNLESS STAMP IS RED		2240 PARAGON DRIVE SAN JOSE CA. 95131 VOICE: 408-441-8081 FAX: 408-441-8085	
gallien technology		TITLE: MB150 POWER AMP	
APPROVALS		SIZE: B	
INIT	DATE	DRAWING NO: 405-0211-A	
DESIGNED: R.A.G.	3/26/01	REV: A	
DRAWN: R.A.G.	12/26/02	PART NO: 145-00211-A	
ELEC:		COMPANY: GALLIEN-KRUEGER	
LAYER DESCRIPTION: S O P S S B E B O B S I O R O N		FILENAME: 5211A.sch	
MECH:		GERBER FILE NAME: sst01289.pcb	

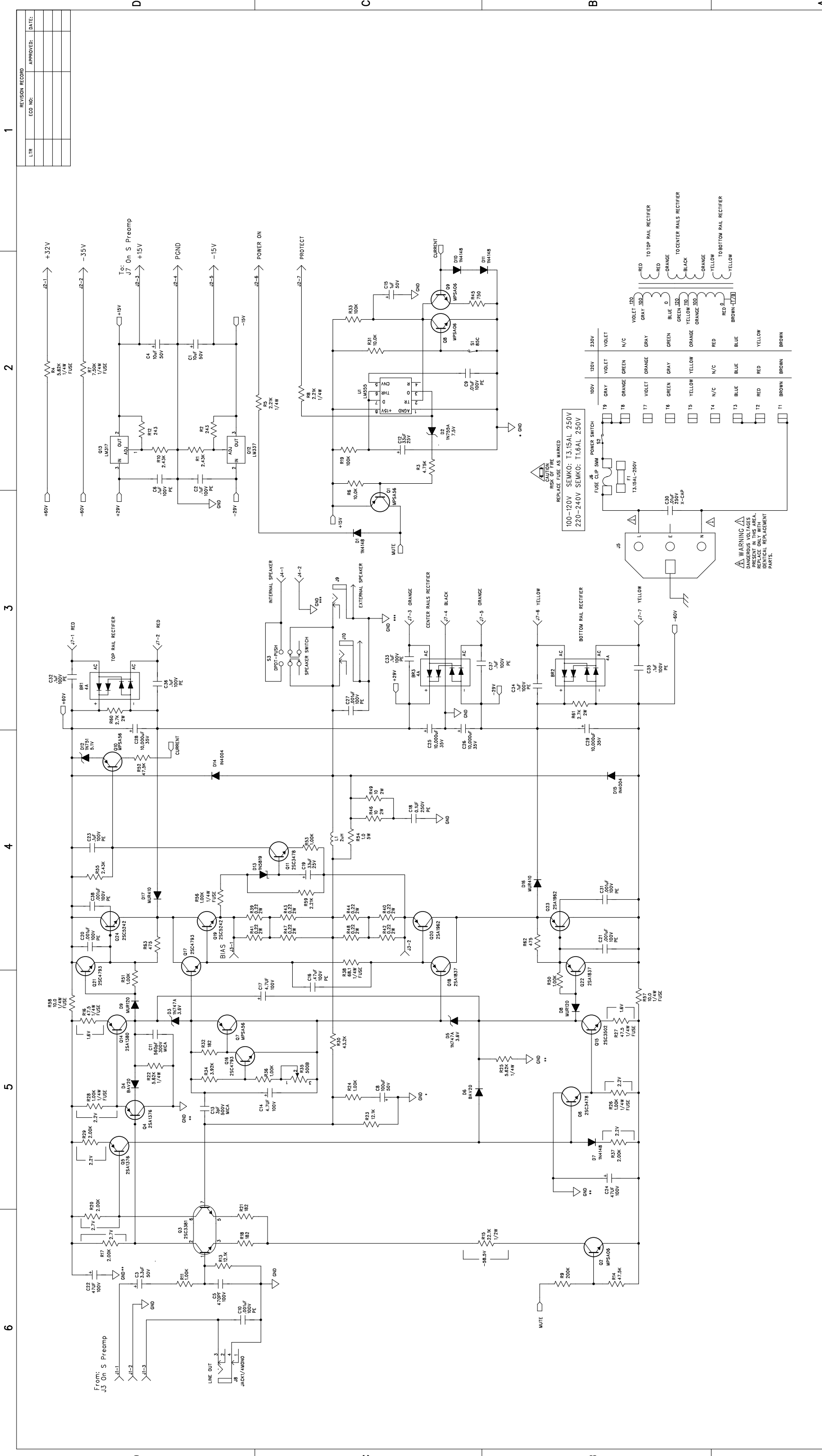

REVISION RECORD

LTR	ECD NO:	APPROVED:	DATE:

gallien technology

2240 PARAGON DRIVE
SAN JOSE CA. 95131
VOICE: 408-441-8081
FAX: 408-441-8085

NOT VALID UNLESS STAMP IS RED

BIAS ADJUSTMENT PROCEDURE
WITH POWER OFF, ADJUST POT R35 TO FULL COUNTER-CLOCKWISE POSITION.
TURN ON POWER AND WAIT 5 SECONDS FOR TURN ON DELAY.
TURN R35 CLOCKWISE UNTIL VOLTAGE ACROSS J3 READS 10 mVDC.

APPROVALS

INIT	DATE
DESIGNED: R.A.G.	2/28/01
DRAWN: R.A.G.	6/26/03

TITLE: MB150-III POWER AMP

1. ADD C20 AND C21
2. CHANGE C31 AND C38 TO .001UF.
3. INCREASE STAR VIA TO POWER VIA.
4. UPDATE BOARD NO. TO 208-0211-A1.
5. MOVE J4 AWAY FROM I/O BOARD.
6. REMOVE TURN ON DELAY FROM ISV SUPPLY.
7. CHANGE C14 TO .01UF - 50V SUPPLY.
8. CHANGED J3 TO 7 PIN.
9. CHANGED C14 & C17 TO 4.7UF/100V.
10. CHANGED J8 TO LINE OUT JACK.

DESIGNED: R.A.G. DATE: 2/28/01
DRAWING NO: 406-0211-A1 REV: A1
PART NO: 208-0211-A1
COMPANY: GALLIEN-KRUEGER
O/A: FLEMME: 6211A1.sch

WARNING
DANGEROUS VOLTAGES
REPLACE ONLY WITH
IDENTICAL REPLACEMENT
PARTS.

REPLACE FUSE AS MARKED
100-120V SEMKO: T3.15AL 250V
220-240V SEMKO: T1.6AL 250V

TO TOP RAIL RECTIFIER
TO CENTER RAILS RECTIFIER
TO BOTTOM RAIL RECTIFIER

MB150-III Power Amp		206-0211-A1			
Part No.	Reference	Description	Manufacturer	Mfr. Part No.	Quan
001-2060-0	U1	LM555, TIMER	NATIONAL	LM555CN	1.00
010-0000-0	Q3	2SC3381BL,NPNX2,80V,100MA,2-10M1B	TOSHIBA	2SC3281BL	1.00
010-0001-0	Q6 Q11	2SC3478, NPN,180V,100MA,TO-92	NEC	2SC3478-K	2.00
010-0003-0	Q15	2SC3502-F,NPN,200V,100MA,TO-126	TOSHIBA	2SC3502	1.00
010-0012-0	Q2 Q8-9	MPSAO6, NPN,80V,500MA,TO-92	MOTOROLA	MPS-A06	3.00
010-1002-0	Q4-5	2SA1376, PNP,180V,100MA,TO-92	NEC	2SA1376-K	2.00
010-1003-0	Q14	2SA1380-F,PNP,200V,100MA,TO-126	SANYO/TOSHIBA	2SA1380-F/E	1.00
010-1013-0	Q1 Q7 Q10	MPSA56 PNP 80V 500MA TO-92	MOTOROLA	MPS-A56	3.00
012-0002-0	Q16-17 Q21	2SC4793,NPN,200V,1.5A,2-10R1A	TOSHIBA	2SC4793	3.00
012-0003-0	Q19 Q24	2SC5242,NPN,230V,15A,2-16C1A	TOSHIBA	2SC5242-O	2.00
012-1002-0	Q18 Q22	2SA1837,PNP,200V,1.5A,2-10R1A	TOSHIBA	2SA1837	2.00
012-1003-0	Q20 Q23	2SA1962,PNP,230V,15A,2-16C1A	TOSHIBA	2SA1962	2.00
014-0070-0	Q13	LM317	NATIONAL	LM317	1.00
014-1072-0	Q12	LM337	NATIONAL	LM337	1.00
020-0004-0	D2	1N755A, ZENER,7.5V,500MW ,D035	TAITRON	1N755A	1.00
020-0036-0	D3 D5	1N747A, ZENER, 3.6V, 5%, 400MW, DO-35	TAITRON	1N747A	2.00
020-0050-0	D12	1N751, ZENER,5.1V,10%,400MW,DO-35	NATIONAL	1N751	1.00
020-1000-0	D1 D7 D10-11	1N4148, RECT-FAST, 200MA, 100V	MOTOROLA	1N4148	4.00
020-1022-0	D4 D6	BAV20, RECT, 200V, DO-35	NATIONAL	BAV20	2.00
020-1104-0	D13	SHOTTKY, 1A, 40V, 10NS, DO-41	MOTOROLA	1N5819	1.00
020-1120-0	D8-9	MUR120,RECT-FAST, 1A, 200V, 25NS, 59-04	MOTOROLA	MUR120	2.00
020-1122-0	D16-17	MUR410, RECT-FAST, 4A, 100V	MOTOROLA	MUR410	2.00
020-2106-0	D14-15	1N4004,RECT,1A,400V,DO-41	TAITRON	1N4004	2.00
023-0005-0	BR1-3	BRIDGE, 4A, 100V, VERT, PC	TAITRON	TU401	3.00
031-1336-0	C12 C19	CAP,ELEC,RAD,336,20%,25V	UNITED CHEMI-CON	SRG25VB33RM5X7LL	2.00
031-2105-0	C15	CAP,ELEC,RAD, 105, 20%, 50V	UNITED CHEMI-CON	C440C105M5U5CA	1.00
031-2106-0	C1 C4	CAP,ELEC,RAD, 106, 20%, 50V	UNITED CHEMI-CON	SMG50VB10RM5X11LL	2.00
031-2107-0	C8	CAP,ELEC,RAD,107, 20%, 50V	UNITED CHEMI-CON	SMG50VB101M8X11LL	1.00
031-2109-1	C25-26 C28-29	CAP, ELEC, RAD, 100,00uF, 35V	UNITED CHEMICON	SMH35VN103M30x30T2	4.00
031-2335-0	C3	CAP,ELEC,RAD,335,20%,50V	UNITED CHEMI-CON	SMG50VB3R3M5X11LL	1.00
031-4475-0	C14 C17	CAP,EL-R,4.7UF/100V, M	UNITED CHEMI-CON	SMG100VB4R7M5X11LL	2.00
031-4476-0	C22 C24	CAP,ELEC,RAD,476,-10%+50%,100V	UNITED CHEMI-CON	SMG100VB47RM10X12LL	2.00
032-4102-0	C10,20,21,27,31,38	CAP,PE,102,5%,100V,	PANASONIC	ECQB1102JF	6.00
032-4103-0	C9	CAP,PE,103,5%,100V,	PANASONIC	ECQV1103JM	1.00
032-4104-0	C2 C6 C23 C32-37	CAP,PE,104,5%,100V,	PANASONIC	ECQV1104JM	9.00
032-4474-0	C16	CAP,PE,474,5%,100V,	PANASONIC	ECQV1474JM	1.00
032-7104-0	C18	CAP,PE,104,10%, 250V	ILLINOIS CAPACITOR	104MSR250K	1.00
034-4471-0	C5	CAP,MCR,470pF,5%,100V,	TAITRON	TMRS471J100NPOB	1.00
034-7103-0	C30	CAP, CERMIC DISK, 103, 10%, X-250V	PANASONIC	ECK-DRS103ZV	1.00
035-8030-0	C13	CAP MICA AXIAL , 3pF, 10%, 500V	CORNELL	CD10CD030D03	1.00
035-8561-0	C11	CAP MICA RADIAL, 561, 5%, 300V	CORNELL	CD15FC561J103	1.00
052-2212-0	R5 R8	RES,METAL FILM,2.21k,1/4W,1%	ECI	M2F1AK002.21	2.00
052-5622-0	R22 R25	RES,METAL FILM,5.62K,1/4W,1%	ECI	M5F1AK005.62	2.00
055-.220-0	R39-44 R47-48	RES, METAL OXIDE, 0.22 Ohm, 2W, 5%	ECI	MOM20J3AJ000.22	8.00
055-0101-0	R46 R49	RES, METAL OXIDE, 10 OHM, 2W, 5%	ECI	MOM20J3AJ010.00	2.00
055-2702-0	R60-61	RES, METAL OXIDE, 2.7K OHM, 2W, 5%	ECI	MOM20J3AK002.70	2.00
056-0100-0	R54	RES, CERAMIC WW, 1.0, 5W, 10%	ECI	WWC50J3AJ001.00	1.00
059-1000-0	R57-58	RES,MF,FUSE,10.0 OHM, 1/4W,1%	JUKN.OHM	FR25-10.0	2.00
059-1002-0	R26 R28	RES,MF,FUSE,1.00K,1/4W,1%	JUKN.OHM	FR25-1.00K	2.00
059-1002-0	R56	RES,MF,FUSE, 1.00K, 1/4W, 1%	JUKN.OHM	FR25-1.00K	1.00
059-4750-0	R16 R27	RES,MF,FUSE,47.5 OHM, 1/4W,1%	JUKN.OHM	FR25-47.5	2.00
059-5622-0	R4	RES,MF,FUSE, 5.62K, 1/4W, 1%	JUKN.OHM	FR25-5.62K	1.00
059-6810-0	R38	RES,MF,FUSE,68.1 OHM, 1/4W,1%	JUKN.OHM	FR25-68.1	1.00
059-7502-0	R7	RES,MF,FUSE, 7.50K, 1/4W, 1%	JUKN.OHM	FR25-7.50K	1.00
060-1002-0	R11,24,36,50,51,53	RES,METAL FILM, 1.00K, 1/8W, 1%	ECI	M1F1AK001.00	6.00
060-1003-0	R6 R31	RES,METAL FILM, 10.0K, 1/8W,1%	ECI	M1F1AK010.00	2.00
060-1004-0	R19 R33	RES,METAL FILM, 100K, 1/8W, 1%	ECI	M1F1AK100.00	2.00
060-1213-0	R13 R23	RES,METAL FILM, 12.1K OHM, 1/8W, 1%	ECI	M1F1AK012.10	2.00
060-1821-0	R18 R21 R32	RES,METAL FILM, 182, 1/8W, 1%	ECI	M1F1AJ182.00	3.00
060-2002-0	R17 R20 R29 R37	RES,METAL FILM, 2.00K, 1/8W, 1%	ECI	M1F1AK002.00	4.00
060-2004-0	R9	RES,METAL FILM, 200K, 1/8W, 1%	ECI	M1F1AK200.00	1.00
060-2212-0	R59	RES,METAL FILM, 2.21K, 1/8W, 1%	ECI	M1F1AK002.21	1.00
060-2431-0	R2 R12	RES,METAL FILM, 243 Ohm, 1/8W, 1%	ECI	M1F1AJ243.00	2.00
060-2432-0	R1 R10 R55	RES,METAL FILM, 2.43K, 1/8W, 1%	ECI	M1F1AK002.43	3.00
060-3922-0	R34	RES,METAL FILM, 3.92K, 1/8W, 1%	ECI	M1F1AK003.92	1.00

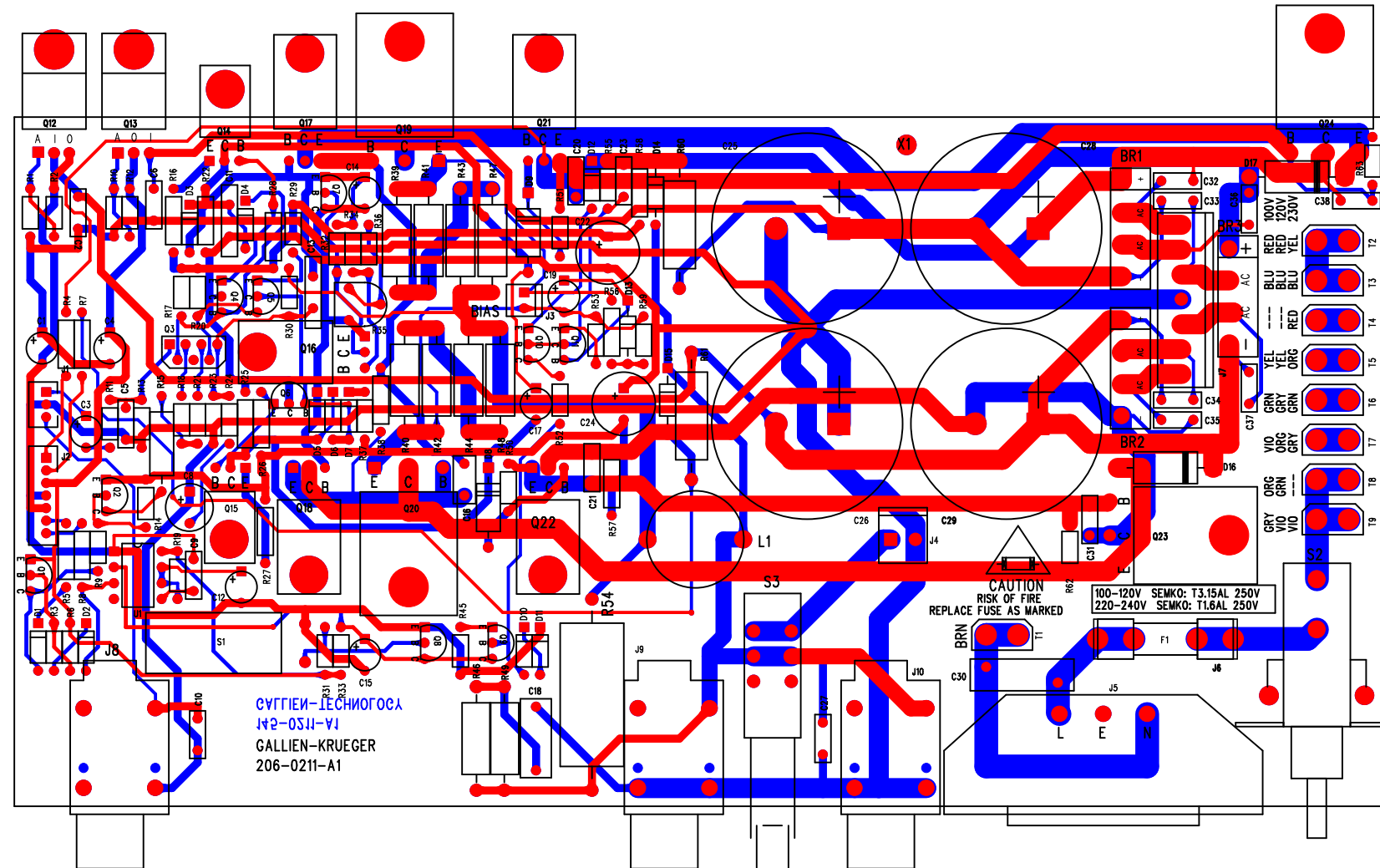

PCB WORK INSTRUCTIONS

DWG 420-0211-A1

NOTES:

UNLESS OTHERWISE SPECIFIED:

1. SQUARE PADS ON THRU HOLE PARTS (ie: CONNECTORS, DIPS, SIPS, LEDS) DENOTE PIN 1.
2. ALL BOARDS REQUIRE A COMPLETE AND THOROUGH VISUAL INSPECTION.
3. ALL BOARDS MUST BE BARE BOARD TESTED.
4. ASSEMBLE AND SOLDER PER ANSI/IPC-A-610B.

LOADING

5. LOAD POWER TRANSISTORS AS INSTRUCTED BELOW AFTER WAVE.

USE A JIG TO POSITION MOUNTING HOLES CORRECTLY.
MOUNT ON BACK SIDE OF BOARD WITH PART NUMBER SIDE
FACING BOTTOM OF BOARD AND THERMAL CONDUCTING SIDE FACING DOWN.

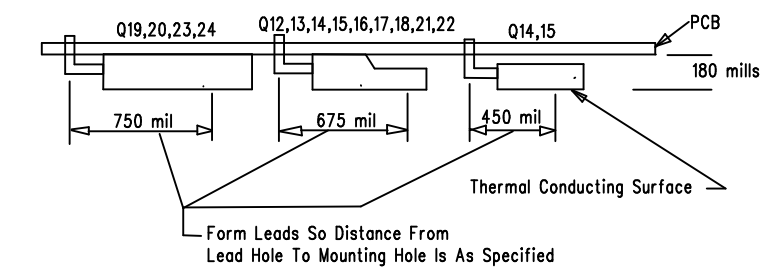

6. MOUNT S1 TO BOTTOM OF BOARD AFTER WAVE AS SHOWN.



7. FUSE LOADING - F1

FOR 100V & 120V MODEL:
LOAD FUSE, 5MM, T3.15AL 250V SEMKO

FOR 230V MODEL:
LOAD FUSE, 5MM, T1.6AL 250V SEMKO

FINAL QA

8. CHECK THAT J1,2,3,4,5,6 & 7 ARE FLUSH WITH PCB AND STRAIGHT.
9. GLUE C30 TO J5 WITH SILICON RTV

NOT VALID UNLESS STAMP IS RED		gallien technology		2240 PARAGON DRIVE SAN JOSE CA. 95131 VOICE: 408-441-8081 FAX: 408-441-8085	
APPROVALS		TITLE: MB150 POWER AMP			
INIT	DATE	SIZE	DRAWING NO:	REV.	
DESIGNED: R.A.G.	3/26/01	B	405-0211-A1	A1	
DRAWN: R.A.G.	6/26/03		PART NO:		
ELEC:		COMPANY:	GALLIEN-KRUEGER		
LAYER DESCRIPTION: S O P S S B E B O B S I O R O I N		MECH:	GERBER FILE NAME:	FILENAME: 5211A1.sch	
			5211A1.pcb		

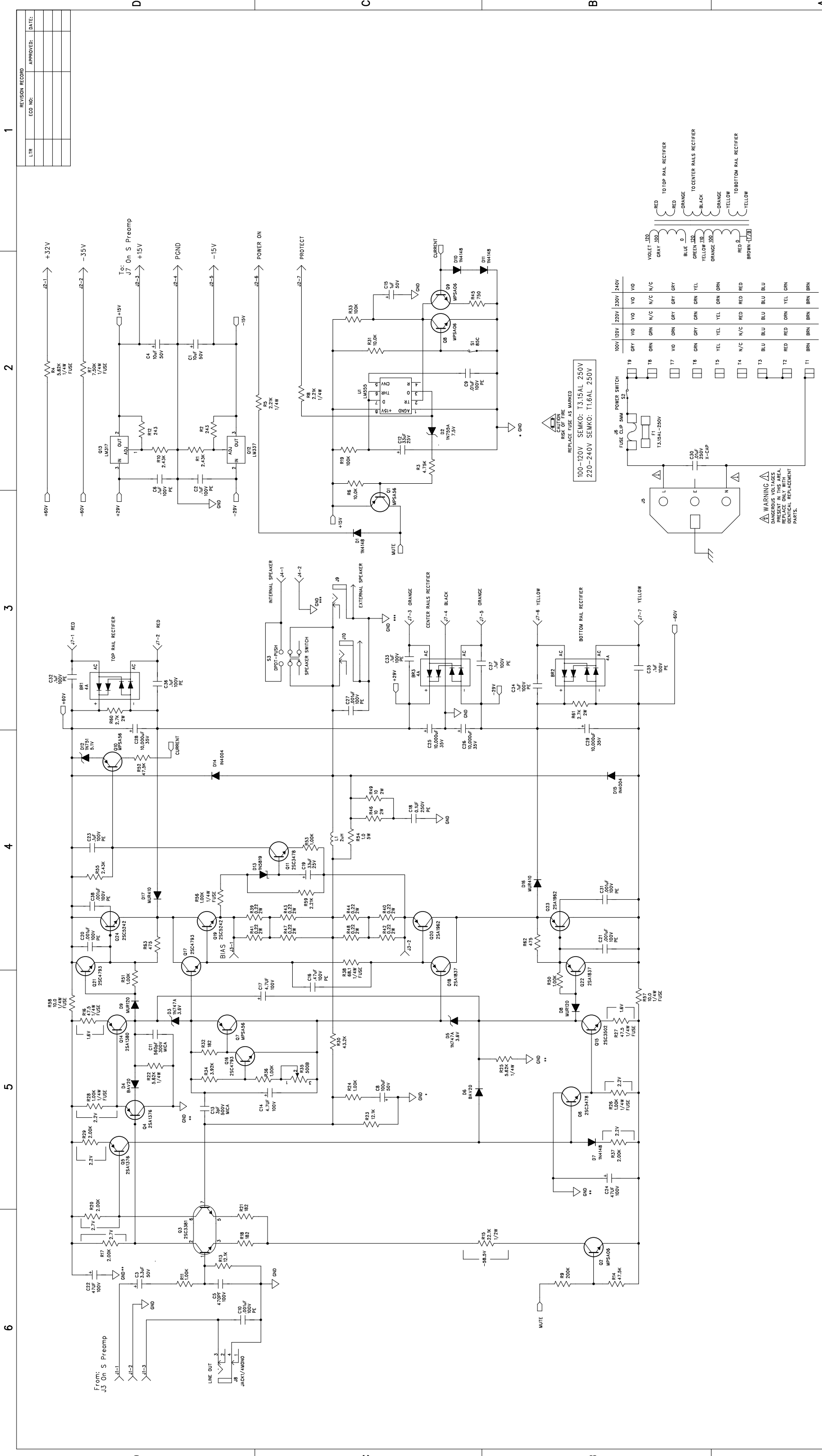

1

REVISION RECORD		APPROVED:	DATE:
LTR	ECD NO:		

2234 INDUSTRIAL DRIVE
STOCKTON, CA. 95208
VOICE: 209-234-7300
FAX: 209-234-8420

gallien technology

NOTES TO REV. A2:
1. ADD 240V SUPPLY TABLE TO LAYOUT.

NOT VALID UNLESS STAMP IS RED

BIAS ADJUSTMENT PROCEDURE
WITH POWER OFF, ADJUST POT R35 TO FULL COUNTER-CLOCKWISE POSITION.
TURN ON POWER AND WAIT 5 SECONDS FOR TURN ON DELAY.
TURN R35 CLOCKWISE UNTIL VOLTAGE ACROSS J3 READS 10 mVDC.

APPROVALS		TITLE:	
INIT	DATE	DESIGNED:	REV.
		R.A.G.	2/28/01
		F.A.G.	11/19/03

PART NO:		REV:	
MB150-III	POWER AMP	406-0211-A2	A2
206-0211-A2			

COMPANY: GALLIEN-KRUEGER
FLEMME: 6211A2.sch

100-120V SEMKO: T3.15AL 250V
220-240V SEMKO: T1.6AL 250V

REPLACE FUSE AS MARKED

CAUTION
RISK OF FIRE
REPLACE FUSE AS MARKED

WARNING
DANGEROUS VOLTAGES
PRESENT IN THIS AREA.
IDENTICAL REPLACEMENT
PARTS.

TO TOP RAIL RECTIFIER
RED TO CENTER RAILS RECTIFIER
ORANGE TO BOTTOM RAIL RECTIFIER

VIOLET 120
GRAY 100
RED
ORANGE
BLUE 0
GREEN 100
YELLOW 100
ORANGE 100
RED 0
BROWN 100

100V 120V 220V 230V 240V
GRAY VIO VIO VIO VIO
ORN GRN N/C N/C N/C
VIO GRN GRN GRN GRN
T8 T7 T6 T5 T4 T3 T2 T1
BRN BRN BRN BRN BRN
BLU BLU BLU
RED RED RED
ORN ORN ORN
YEL YEL YEL
N/C N/C N/C

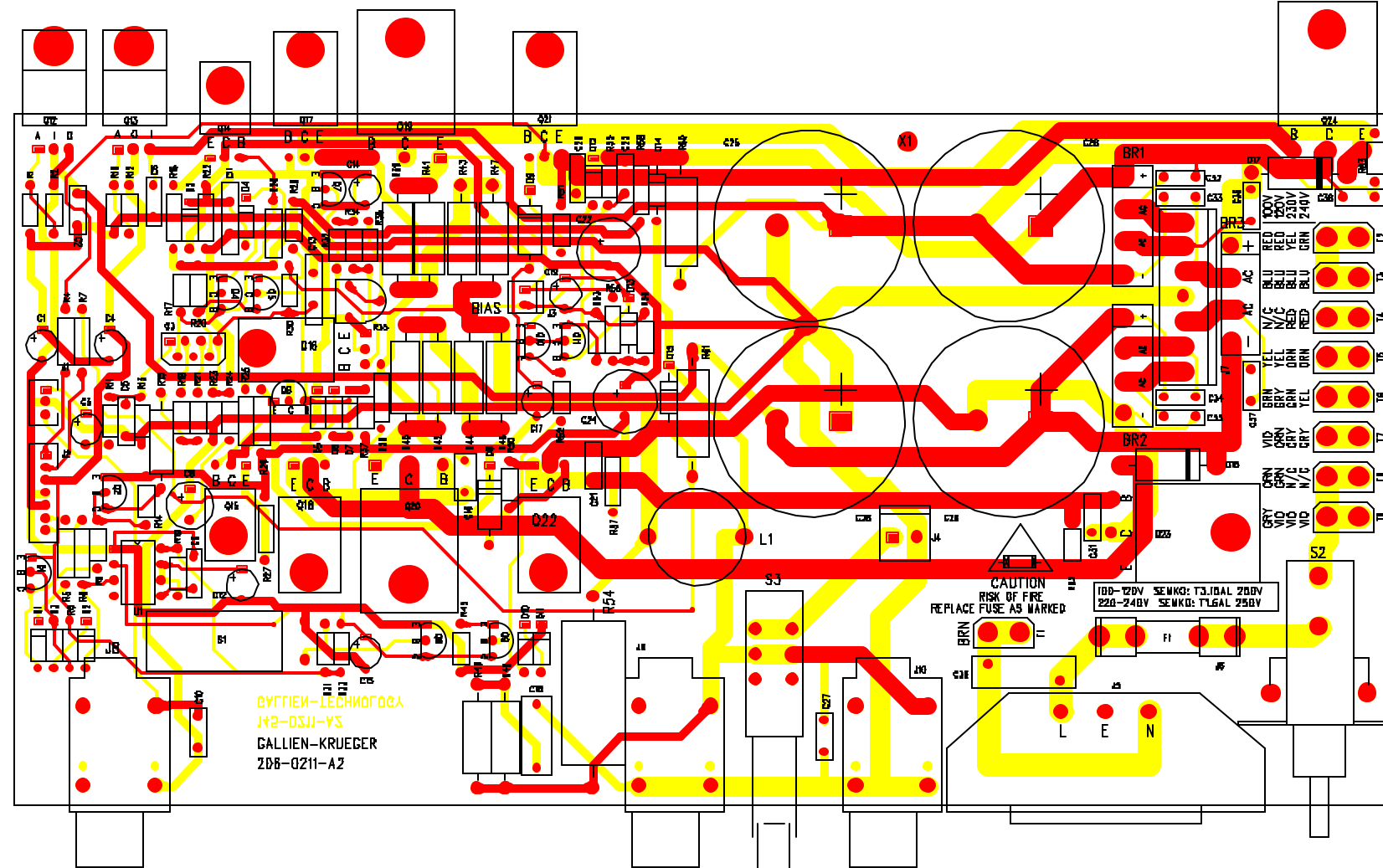

PCB WORK INSTRUCTIONS

DWG 420-0211-A2

NOTES:

UNLESS OTHERWISE SPECIFIED:

1. SQUARE PADS ON THRU HOLE PARTS (ie: CONNECTORS, DIPs, SIPS, LEDS) DENOTE PIN 1.
2. ALL BOARDS REQUIRE A COMPLETE AND THOROUGH VISUAL INSPECTION.
3. ALL BOARDS MUST BE BARE BOARD TESTED.
4. ASSEMBLE AND SOLDER PER ANSI/IPC-A-810B.

LOADING

5. LOAD POWER TRANSISTORS AS INSTRUCTED BELOW AFTER WAVE.

USE A JIG TO POSITION MOUNTING HOLES CORRECTLY.
MOUNT ON BACK SIDE OF BOARD WITH PART NUMBER SIDE
FACING BOTTOM OF BOARD AND THERMAL CONDUCTING SIDE FACING DOWN.

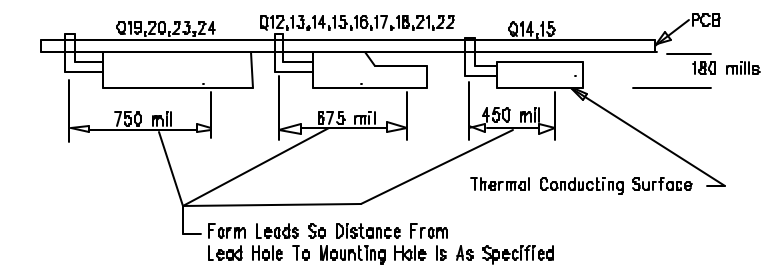

6. MOUNT S1 TO BOTTOM OF BOARD AFTER WAVE AS SHOWN.



7. FUSE LOADING - F1

FOR 100V & 120V MODEL:
LOAD FUSE, 5MM, T3.15AL 250V SEMKO

FOR 230V MODEL:
LOAD FUSE, 5MM, T1.6AL 250V SEMKO

FINAL QA

8. CHECK THAT J1,2,3,4,5,6 & 7 ARE FLUSH WITH PCB AND STRAIGHT.
9. GLUE C30 TO J5 WITH SILICON RTV

NOT VALID UNLESS STAMP IS RED		2240 PARAGON DRIVE SAN JOSE CA. 95131 VOICE: 408-441-8081 FAX: 408-441-8085	
gallien technology		TITLE: MB150 POWER AMP	
APPROVALS		SIZE: B	DRAWING NO: 405-0211-A2
INIT	DATE	REV: A2	PART NO: 145-00211-A2
DESIGNED: R.A.G.	3/26/01		
DRAWN: R.A.G.	11/19/03	COMPANY: GALLIEN-KRUEGER	
ELEC:		FILENAME: 5211A2.sch	
MECH:		GERBER FILE NAME: sst01219.pcb	
LAYER DESCRIPTION: S.D.R.S.D.B.E.F.R.O.B.S.T.R.N			

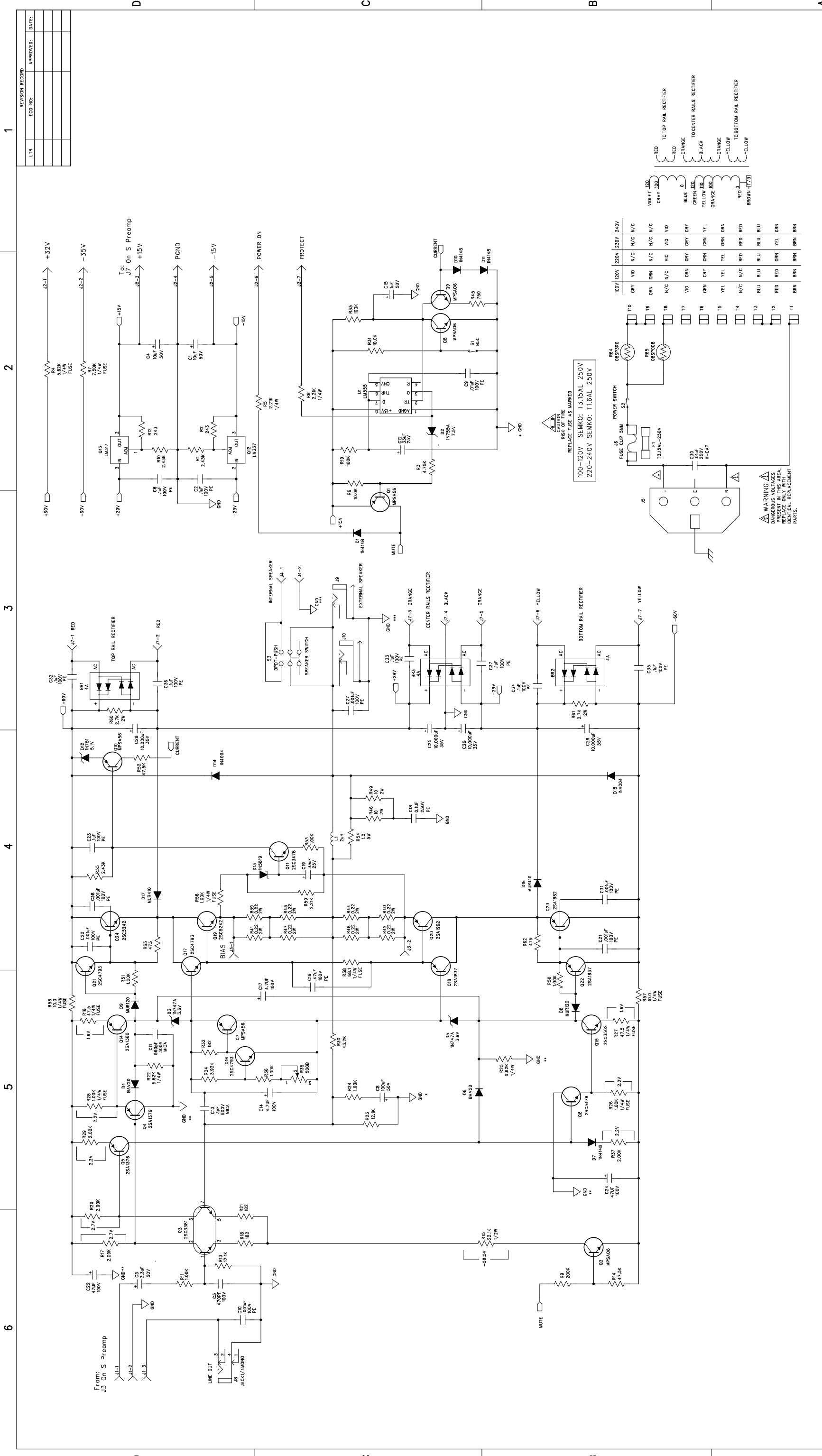

1
2
3
4
5
6

gallien technology

2234 INDUSTRIAL DRIVE
STOCKTON, CA. 95206
VOICE: 209-234-7300
FAX: 209-234-8420

NOT VALID UNLESS STAMP IS RED

XI

BIAS ADJUSTMENT PROCEDURE
WITH POWER OFF, ADJUST POT R35 TO FULL COUNTER-CLOCKWISE POSITION.
TURN ON POWER AND WAIT 5 SECONDS FOR TURN ON DELAY.
TURN R35 CLOCKWISE UNTIL VOLTAGE ACROSS J3 READS 10 mVDC.

WARNING
DANGEROUS VOLTAGES
PRESENT IN THIS AREA.
IDENTICAL REPLACEMENT
PARTS.

CAUTION
REPLACE FUSE AS MARKED

100-120V SEMKO: T3.15AL 250V
220-240V SEMKO: T1.6AL 250V

TO TOP RAIL RECTIFIER
TO CENTER RAILS RECTIFIER
TO BOTTOM RAIL RECTIFIER

100V 120V 220V 230V 240V
GRY VIO N/C N/C N/C N/C
GRN GRN N/C N/C N/C N/C
VIO GRN GRN GRN GRN
BLK 0
ORNGE TO CENTER RAILS RECTIFIER
GRN GRN GRN GRN YEL
YEL GRN GRN GRN GRN
N/C N/C N/C N/C RED RED
BLU BLU BLU BLU
RED RED GRN YEL GRN
BRN BRN BRN BRN

APPROVALS
INIT DATE
DESIGNED: R.A.G. 12/28/01
DRAWN: R.A.G. 12/11/03
ELEC: B
MECH:
O/A:
RELEASED:

TITLE: MB150-III POWER AMP
DRAWING NO: 406-0211-A3
PART NO: 206-0211-A3
COMPANY: GALLIEN-KRUEGER
FILENAME: 6211A3.sch

NOTES TO REV A3:
1. MODIFY SUPPLY TABLE FOR THERMISTORS.
2. ADD THERMISTORS R64 AND R65.
3. ADD TB.

REVISION RECORD

LTR	ECD NO:	APPROVED:	DATE:

GK GALLIEN-KRUEGER

MB150-III Power Amp		Costed Bill Of Material		206-0211-A3		
Part No.	Reference	Description	Manufacturer	Mfr. Part No.	Quan	\$ Ea.
001-2060-0	U1	LM555, TIMER	NATIONAL	LM555CN	1.00	0.175
010-0000-0	Q3	2SC3381BL,NPNX2,80V,100MA,2-10M1B	TOSHIBA	2SC3281BL	1.00	0.590
010-0001-0	Q6 Q11	2SC3478, NPN,180V,100MA,TO-92	NEC	2SC3478-K	2.00	0.137
010-0003-0	Q15	2SC3502-F,NPN,200V,100MA,TO-126	TOSHIBA	2SC3502	1.00	0.230
010-0012-0	Q2 Q8-9	MPSA06, NPN,80V,500MA,TO-92	MOTOROLA	MPS-A06	3.00	0.041
010-1002-0	Q4-5	2SA1376, PNP,180V,100MA,TO-92	NEC	2SA1376-K	2.00	0.135
010-1003-0	Q14	2SA1380-F,PNP,200V,100MA,TO-126	SANYO/TOSHIBA	2SA1380-F/E	1.00	0.230
010-1013-0	Q1 Q7 Q10	MPSA56 PNP 80V 500MA TO-92	MOTOROLA	MPS-A56	3.00	0.040
012-0002-0	Q16-17 Q21	2SC4793,NPN,200V,1.5A,2-10R1A	TOSHIBA	2SC4793	3.00	0.312
012-0003-0	Q19 Q24	2SC5242,NPN,230V,15A,2-16C1A	TOSHIBA	2SC5242-O	2.00	1.197
012-1002-0	Q18 Q22	2SA1837,PNP,200V,1.5A,2-10R1A	TOSHIBA	2SA1837	2.00	0.318
012-1003-0	Q20 Q23	2SA1962,PNP,230V,15A,2-16C1A	TOSHIBA	2SA1962	2.00	1.097
014-0070-0	Q13	LM317	NATIONAL	LM317	1.00	0.000
014-1072-0	Q12	LM337	NATIONAL	LM337	1.00	0.000
020-0004-0	D2	1N755A, ZENER,7.5V,500MW ,D035	TAITRON	1N755A	1.00	0.025
020-0036-0	D3 D5	1N747A, ZENER, 3.6V, 5%, 400MW, DO-35	TAITRON	1N747A	2.00	0.000
020-0050-0	D12	1N751, ZENER,5.1V,10%,400MW,DO-35	NATIONAL	1N751	1.00	0.018
020-1000-0	D1 D7 D10-11	1N4148, RECT-FAST, 200MA, 100V	MOTOROLA	1N4148	4.00	0.008
020-1022-0	D4 D6	BAV20, RECT, 200V, DO-35	NATIONAL	BAV20	2.00	0.018
020-1104-0	D13	SHOTTKY, 1A, 40V, 10NS, DO-41	MOTOROLA	1N5819	1.00	0.075
020-1120-0	D8-9	MUR120,RECT-FAST, 1A, 200V, 25NS, 59-04	MOTOROLA	MUR120	2.00	0.000
020-1122-0	D16-17	MUR410, RECT-FAST, 4A, 100V	MOTOROLA	MUR410	2.00	0.125
020-2106-0	D14-15	1N4004,RECT,1A,400V,DO-41	TAITRON	1N4004	2.00	0.010
022-3010-0	R64	THERMISTOR, 3 OHM, 3 AMP	UEI	08SP003M	1.00	0.000
022-3015-0	R65	THERMISTOR, 8 OHM, 3 AMP	UEI	08SP008M	1.00	0.000
023-0005-0	BR1-3	BRIDGE, 4A, 100V, VERT, PC	TAITRON	TU401	3.00	0.000
031-1336-0	C12 C19	CAP,ELEC,RAD,336,20%,25V	UNITED CHEMI-CON	SRG25VB33RM5X7LL	2.00	0.011
031-2105-0	C15	CAP,ELEC,RAD, 105, 20%, 50V	UNITED CHEMI-CON	C440C105M5U5CA	1.00	0.010
031-2106-0	C1 C4	CAP,ELEC,RAD, 106, 20%, 50V	UNITED CHEMI-CON	SMG50VB10RM5X11LL	2.00	0.011
031-2107-0	C8	CAP,ELEC,RAD,107, 20%, 50V	UNITED CHEMI-CON	SMG50VB101M8X11LL	1.00	0.000
031-2109-1	C25-26 C28-29	CAP, ELEC, RAD, 10,000uF, 35V	UNITED CHEMICON	SMH35VN103M30x30T2	4.00	1.570
031-2335-0	C3	CAP,ELEC,RAD,335,20%,50V	UNITED CHEMI-CON	SMG50VB3R3M5X11LL	1.00	0.010
031-4475-0	C14 C17	CAP,EL-R,4.7UF/100V, M	UNITED CHEMI-CON	SMG100VB4R7M5X11LL	2.00	0.000
031-4476-0	C22 C24	CAP,ELEC,RAD,476,-10%+50%,100V	UNITED CHEMI-CON	SMG100VB47RM10X12LL	2.00	0.000
032-4102-0	C10,20,21,27,31,38	CAP,PE,102.5%,100V,	PANASONIC	ECQB1102JF	6.00	0.054
032-4103-0	C9	CAP,PE,103.5%,100V,	PANASONIC	ECQV1103JM	1.00	0.052
032-4104-0	C2 C6 C23 C32-37	CAP,PE,104.5%,100V,	PANASONIC	ECQV1104JM	9.00	0.058
032-4474-0	C16	CAP,PE,474.5%,100V,	PANASONIC	ECQV1474JM	1.00	0.130
032-7104-0	C18	CAP,PE,104,10%, 250V	ILLINOIS CAPACITOR	104MSR250K	1.00	0.100
034-4471-0	C5	CAP,MCR,470pF,5%,100V,	TAITRON	TMRS471J100NPOB	1.00	0.025
034-7103-0	C30	CAP, CERMIC DISK, 103, 10%, X-250V	PANASONIC	ECK-DRS103ZV	1.00	0.143
035-8030-0	C13	CAP MICA AXIAL , 3pF, 10%, 500V	CORNELL	CD10CD030D03	1.00	0.330
035-8561-0	C11	CAP MICA RADIAL, 561, 5%, 300V	CORNELL	CD15FC561J103	1.00	0.000
052-2212-0	R5 R8	RES,METAL FILM,2.21k,1/4W,1%	ECI	M2F1AK002.21	2.00	0.004
052-5622-0	R22 R25	RES,METAL FILM,5.62K,1/4W,1%	ECI	M5F1AK005.62	2.00	0.004
055-.220-0	R39-44 R47-48	RES, METAL OXIDE, 0.22 Ohm, 2W, 5%	ECI	MOM20J3AJ000.22	8.00	0.073
055-0101-0	R46 R49	RES, METAL OXIDE, 10 OHM, 2W, 5%	ECI	MOM20J3AJ010.00	2.00	0.025
055-2702-0	R60-61	RES, METAL OXIDE, 2.7K OHM, 2W, 5%	ECI	MOM20J3AK002.70	2.00	0.019
056-0100-0	R54	RES, CERAMIC WW, 1.0, 5W, 10%	ECI	WWC50J3AJ001.00	1.00	0.055
059-1000-0	R57-58	RES,MF,FUSE,10.0 OHM, 1/4W,1%	JUKN.OHM	FR25-10.0	2.00	0.009
059-1002-0	R26 R28	RES,MF,FUSE,1.00K,1/4W,1%	JUKN.OHM	FR25-1.00K	2.00	0.009
059-1002-0	R56	RES,MF,FUSE, 1.00K, 1/4W, 1%	JUKN.OHM	FR25-1.00K	1.00	0.009
059-4750-0	R16 R27	RES,MF,FUSE,47.5 OHM, 1/4W,1%	JUKN.OHM	FR25-47.5	2.00	0.009
059-5622-0	R4	RES,MF,FUSE, 5.62K, 1/4W, 1%	JUKN.OHM	FR25-5.62K	1.00	0.009
059-6810-0	R38	RES,MF,FUSE,68.1 OHM, 1/4W,1%	JUKN.OHM	FR25-68.1	1.00	0.009
059-7502-0	R7	RES,MF,FUSE, 7.50K, 1/4W, 1%	JUKN.OHM	FR25-7.50K	1.00	0.009
060-1002-0	R11,24,36,50,51,53	RES,METAL FILM, 1.00K, 1/8W, 1%	ECI	M1F1AK001.00	6.00	0.007
060-1003-0	R6 R31	RES,METAL FILM, 10.0K, 1/8W,1%	ECI	M1F1AK010.00	2.00	0.007
060-1004-0	R19 R33	RES,METAL FILM, 100K, 1/8W, 1%	ECI	M1F1AK100.00	2.00	0.007
060-1213-0	R13 R23	RES,METAL FILM, 12.1K OHM, 1/8W, 1%	ECI	M1F1AK012.10	2.00	0.007
060-1821-0	R18 R21 R32	RES,METAL FILM, 182, 1/8W, 1%	ECI	M1F1AJ182.00	3.00	0.007
060-2002-0	R17 R20 R29 R37	RES,METAL FILM, 2.00K, 1/8W, 1%	ECI	M1F1AK002.00	4.00	0.007
060-2004-0	R9	RES,METAL FILM, 200K, 1/8W, 1%	ECI	M1F1AK200.00	1.00	0.007
060-2212-0	R59	RES,METAL FILM, 2.21K, 1/8W, 1%	ECI	M1F1AK002.21	1.00	0.007
060-2431-0	R2 R12	RES,METAL FILM, 243 Ohm, 1/8W, 1%	ECI	M1F1AJ243.00	2.00	0.007
060-2432-0	R1 R10 R55	RES,METAL FILM, 2.43K, 1/8W, 1%	ECI	M1F1AK002.43	3.00	0.007
060-3922-0	R34	RES,METAL FILM, 3.92K, 1/8W, 1%	ECI	M1F1AK003.92	1.00	0.007

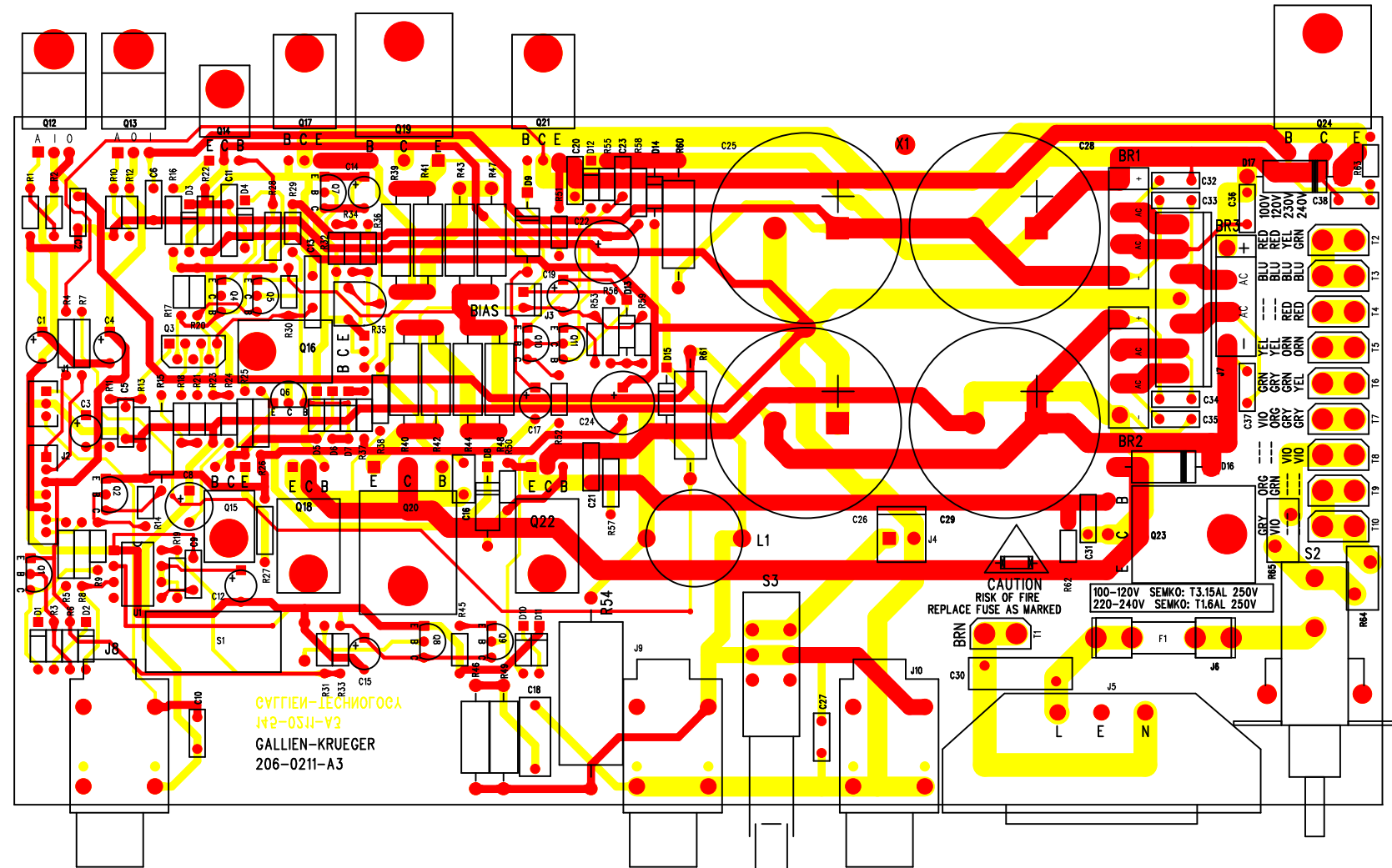

PCB WORK INSTRUCTIONS

DWG 420-0211-A3

NOTES:

UNLESS OTHERWISE SPECIFIED:

1. SQUARE PADS ON THRU HOLE PARTS (ie: CONNECTORS, DIPS, SIPS, LEDS) DENOTE PIN 1.
2. ALL BOARDS REQUIRE A COMPLETE AND THOROUGH VISUAL INSPECTION.
3. ALL BOARDS MUST BE BARE BOARD TESTED.
4. ASSEMBLE AND SOLDER PER ANSI/IPC-A-610B.

LOADING

5. LOAD POWER TRANSISTORS AS INSTRUCTED BELOW AFTER WAVE.
USE A JIG TO POSITION MOUNTING HOLES CORRECTLY.
MOUNT ON BACK SIDE OF BOARD WITH PART NUMBER SIDE
FACING BOTTOM OF BOARD AND THERMAL CONDUCTING SIDE FACING DOWN.

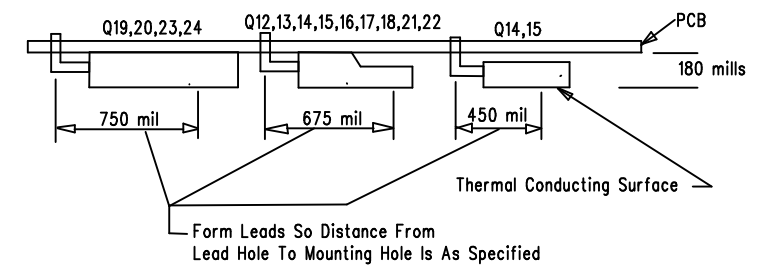

6. MOUNT S1 TO BOTTOM OF BOARD AFTER WAVE AS SHOWN.



7. FUSE LOADING - F1
FOR 100V & 120V MODEL:
LOAD FUSE, 5MM, T3.15AL 250V SEMKO

FOR 230V MODEL:
LOAD FUSE, 5MM, T1.6AL 250V SEMKO

FINAL QA

8. CHECK THAT J1,2,3,4,5,6 & 7 ARE FLUSH WITH PCB AND STRAIGHT.
9. GLUE C30 TO J5 WITH SILICON RTV

NOT VALID UNLESS STAMP IS RED		gallien technology		2234 INDUSTRIAL DRIVE STOCKTON CA. 95206 VOICE: 209-234-7300 FAX: 209-234-8420	
APPROVALS		TITLE: MB150 POWER AMP			
INIT	DATE	SIZE	DRAWING NO:	REV.	
DESIGNED: R.A.G.	3/26/01	B	405-0211-A3	A3	
DRAWN: R.A.G.	12/11/03		PART NO:		
ELEC:		COMPANY: GALLIEN-KRUEGER			
LAYER DESCRIPTION: S O P S S B E B O B S I O R O I N		GERBER FILE NAME: sst01239.pcb		FILENAME: 5211A3.sch	

1 2 3 4 5 6

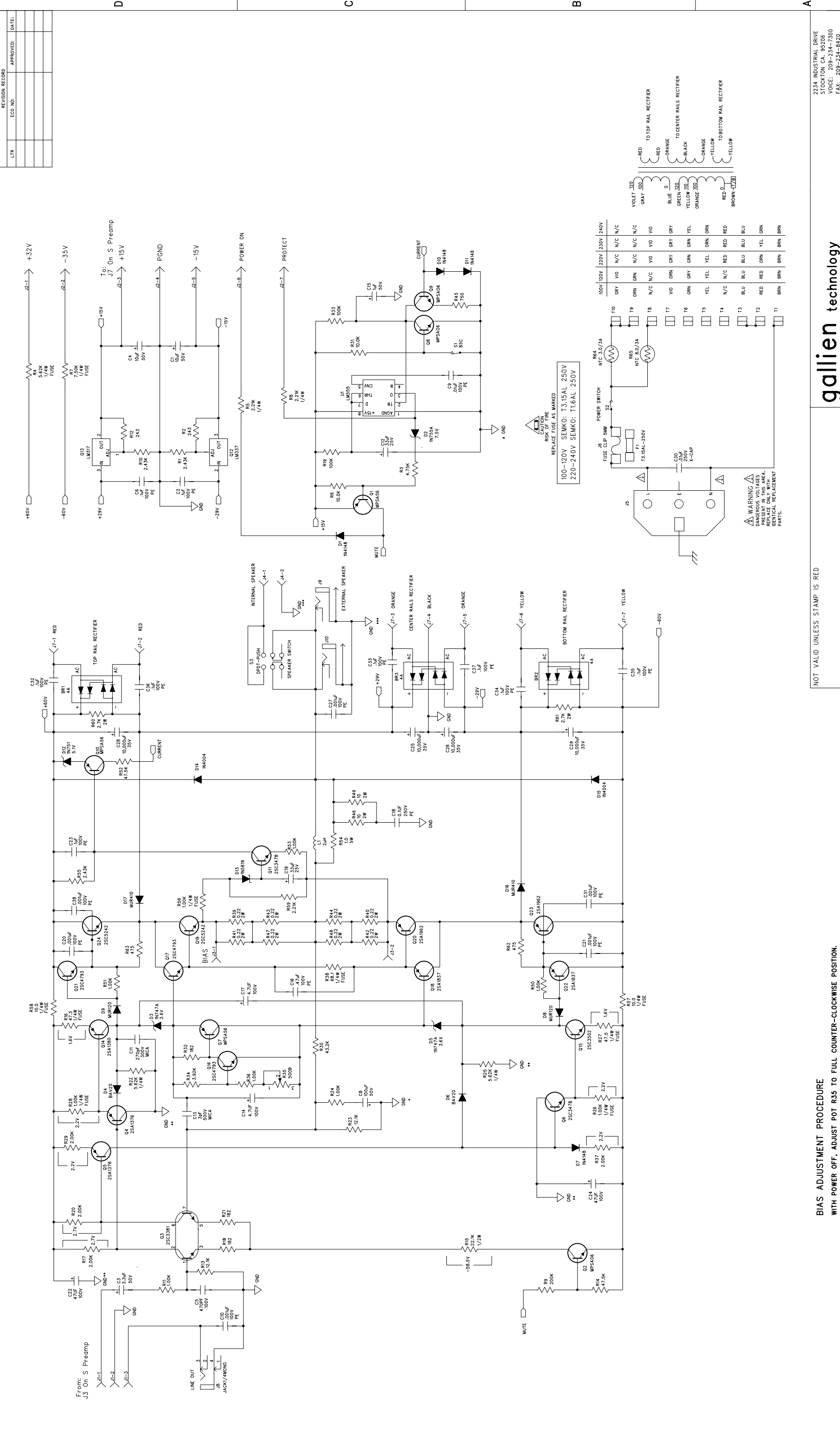

REVISION RECORD		DATE:	
LTR	ECO NO:	APPROVED:	DATE:

APPROVALS		DATE
INIT	R.A.G.	2/28/01
DRAWN	R.A.G.	2/13/04
ELEC:		
MECH:		
G/A:		
RELEASED:		

TITLE:	MB150-III POWER AMP
DESIGNED:	R.A.G.
DRAWING NO:	406-0211-A4
SIZE:	B
PART NO:	206-0211-A4
REV:	A4
COMPANY:	GALLIEN-KRUEGER
FILENAME:	6211A4.sch

NOTES TO REV A4:
 1. CHANGE C11 TO 270pF FROM 500pF.

gallien technology

NOT VALID UNLESS STAMP IS RED

BIAS ADJUSTMENT PROCEDURE
 WITH POWER OFF, ADJUST POT R35 TO FULL COUNTER-CLOCKWISE POSITION.
 TURN ON POWER AND WAIT 5 SECONDS FOR TURN ON DELAY.
 TURN R35 CLOCKWISE UNTIL VOLTAGE ACROSS J5 READS 10 mVDC.



Part No.	Reference	Description
001-2060-0	U1	LM555, TIMER
010-0000-0	Q3	2SC3381BL,NPNX2,80V,100MA,2-10M1B
010-0001-0	Q6 Q11	2SC3478, NPN,180V,100MA,TO-92
010-0003-0	Q15	2SC3502-F,NPN,200V,100MA,TO-126
010-0012-0	Q2 Q8-9	MPSAO6, NPN,80V,500MA,TO-92
010-1002-0	Q4-5	2SA1376, PNP,180V,100MA,TO-92
010-1003-0	Q14	2SA1380-F,PNP,200V,100MA,TO-126
010-1013-0	Q1 Q7 Q10	MPSA56 PNP 80V 500MA TO-92
012-0002-0	Q16-17 Q21	2SC4793,NPN,200V,1.5A,2-10R1A
012-0003-0	Q19 Q24	2SC5242,NPN,230V,15A,2-16C1A
012-1002-0	Q18 Q22	2SA1837,PNP,200V,1.5A,2-10R1A
012-1003-0	Q20 Q23	2SA1962,PNP,230V,15A,2-16C1A
014-0070-0	Q13	LM317
014-1072-0	Q12	LM337
020-0004-0	D2	1N755A, ZENER,7.5V,500MW ,D035
020-0036-0	D3 D5	1N747A, ZENER, 3.6V, 5%, 400MW, DO-35
020-0050-0	D12	1N751, ZENER,5.1V,10%,400MW,DO-35
020-1000-0	D1 D7 D10-11	1N4148, RECT-FAST, 200MA, 100V
020-1022-0	D4 D6	BAV20, RECT, 200V, DO-35
020-1104-0	D13	SHOTTKY, 1A, 40V, 10NS, DO-41
020-1120-0	D8-9	MUR120,RECT-FAST, 1A, 200V, 25NS, 59-04
020-1122-0	D16-17	MUR410, RECT-FAST, 4A, 100V
020-2106-0	D14-15	1N4004,RECT,1A,400V,DO-41
022-3010-0	R64	THERMISTOR, 3 OHM, 3 AMP
022-3015-0	R65	THERMISTOR, 8 OHM, 3 AMP
023-0005-0	BR1-3	BRIDGE, 4A, 100V, VERT, PC
031-1336-0	C12 C19	CAP,ELEC,RAD,336,20%,25V
031-2105-0	C15	CAP,ELEC,RAD, 105, 20%, 50V
031-2106-0	C1 C4	CAP,ELEC,RAD, 106, 20%, 50V
031-2107-0	C8	CAP,ELEC,RAD,107, 20%, 50V
031-2109-1	C25-26 C28-29	CAP, ELEC, RAD, 10,000uF, 35V
031-2335-0	C3	CAP,ELEC,RAD,335,20%,50V
031-4475-0	C14 C17	CAP,EL-R,4.7UF/100V, M
031-4476-0	C22 C24	CAP,ELEC,RAD,476,-10%+50%,100V
032-4102-0	C10,20,21,27,31,38	CAP,PE,102,5%,100V,
032-4103-0	C9	CAP,PE,103,5%,100V,
032-4104-0	C2 C6 C23 C32-37	CAP,PE,104,5%,100V,
032-4474-0	C16	CAP,PE,474,5%,100V,
032-7104-0	C18	CAP,PE,104,10%, 250V
034-4471-0	C5	CAP,MCR,470pF,5%,100V,
034-7103-0	C30	CAP, CERMIC DISK, 103, 10%, X-250V
035-8030-0	C13	CAP MICA RADIAL, 3pF, 10%, 500V
035-8271-0	C11	CAP MICA RADIAL, 271, 5%, 300V
052-2212-0	R5 R8	RES,METAL FILM,2.21k,1/4W,1%
052-5622-0	R22 R25	RES,METAL FILM,5.62K,1/4W,1%
055-220-0	R39-44 R47-48	RES, METAL OXIDE, 0.22 Ohm, 2W, 5%
055-0101-0	R46 R49	RES, METAL OXIDE, 10 OHM, 2W, 5%
055-2702-0	R60-61	RES, METAL OXIDE, 2.7K OHM, 2W, 5%
056-0100-0	R54	RES, CERAMIC WW, 1.0, 5W, 10%
059-1000-0	R57-58	RES,MF,FUSE,10.0 OHM, 1/4W,1%
059-1002-0	R26 R28	RES,MF,FUSE,1.00K,1/4W,1%
059-1002-0	R56	RES,MF,FUSE, 1.00K, 1/4W, 1%
059-4750-0	R16 R27	RES,MF,FUSE,47.5 OHM, 1/4W,1%
059-5622-0	R4	RES,MF,FUSE, 5.62K, 1/4W, 1%
059-6810-0	R38	RES,MF,FUSE,68.1 OHM, 1/4W,1%
059-7502-0	R7	RES,MF,FUSE, 7.50K, 1/4W, 1%
060-1002-0	R11,24,36,50,51,53	RES,METAL FILM, 1.00K, 1/8W, 1%
060-1003-0	R6 R31	RES,METAL FILM, 10.0K, 1/8W,1%
060-1004-0	R19 R33	RES,METAL FILM, 100K, 1/8W, 1%
060-1213-0	R13 R23	RES,METAL FILM, 12.1K OHM, 1/8W, 1%
060-1821-0	R18 R21 R32	RES,METAL FILM, 182, 1/8W, 1%
060-2002-0	R17 R20 R29 R37	RES,METAL FILM, 2.00K, 1/8W, 1%
060-2004-0	R9	RES,METAL FILM, 200K, 1/8W, 1%
060-2212-0	R59	RES,METAL FILM, 2.21K, 1/8W, 1%
060-2431-0	R2 R12	RES,METAL FILM, 243 Ohm, 1/8W, 1%
060-2432-0	R1 R10 R55	RES,METAL FILM, 2.43K, 1/8W, 1%
060-3922-0	R34	RES,METAL FILM, 3.92K, 1/8W, 1%

Part No.	Reference	Description
060-4323-0	R30	RES,METAL FILM, 43.2K, 1/8W, 1%
060-4751-0	R62-63	RES,METAL FILM, 475 ohm, 1/8W, 1%
060-4752-0	R3	RES,METAL FILM, 4.75K, 1/8W, 1%
060-4753-0	R14 R52	RES,METAL FILM, 47.5K, 1/8W, 1%
060-7501-0	R45	RES,METAL FILM, 750 OHM, 1/8W, 1%
061-2213-0	R15	RES ,METAL FILM,22.1K,1/2W,1%
070-0520-0	R35	POT,500B TRIM, 200mW
081-0055-0	L1	INDUCTOR,2UH,20A,AIR CORE
090-0007-0	S2	SWITCH, 8A/128A,250V,PP,PCB
090-0014-0	S3	SWITCH,PP,DPDT,,5A,BREAK/MAKE
091-0012-0	F1	FUSE,5mm,T3.15AL,250V,SEMKO
091-1001-0	S1	THRM BRKR, 85C +/-5,0-DIFF, PC
092-0001-0	J5	CON, IECX3, 10A, 250V, PC TERM
092-0066-0	T1-10	FASTON, M, PC, .250"
092-0081-0	J8	JACK,1/4",MONO,PC,NON GROUNDING
092-0082-0	J9-10	JACK,1/4",MONO,PC, GROUNDING
093-0025-0	J3	HDR,,1X2,VERT,MALE,LOCK,GOLD
093-0043-0	J1	HDR, 2MMX3, VERT, LOCK
093-1010-0	J7	HDR,,156X7,VERT,MALE,LOCK,SQUARE
093-1011-0	J4	HDR,,156X2,VERT,MALE,LOCK,SQUARE
093-2005-0	J2	HDR, 2MMX7, VERT, SHROUDED
094-0004-0	J6	FUSE CLIP, 5MM, 15A, P.C.
145-0211-A2		MB150-III POWER AMP BOARD

GK GALLIEN-KRUEGER

MB150-III Power Amp		Costed Bill Of Material		206-021 1-A6	
Part No.	Reference	Description	Manufacturer	Mfr. Part No.	Quan
032-4102-0	C10 C20-21 C27 C31 C38	CAP,PE,102,5%,100V,	PANASONIC	ECQB1102JF	6
032-4103-0	C9	CAP,PE,103,5%,100V,	PANASONIC	ECQV1103JM	1
034-7103-0	C30	CAP, CERMIC DISK, 103, 10%, X-250V	PANASONIC	ECK-DRS103ZV	1
032-4104-0	C2 C6 C23 C32-37	CAP,PE,104,5%,100V,	PANASONIC	ECQV1104JM	9
032-7104-0	C18	CAP,PE,104,10%, 250V	ILLINOIS CAPACITOR	104MSR250K	1
032-4474-0	C16	CAP,PE,474,5%,100V,	PANASONIC	ECQV1474JM	1
031-2109-1	C25-26 C28-29	CAP, ELEC, RAD, 10,000uF, -10% +50%, 35V	UNITED CHEMICON	SMH35VN103M30x30T2	4
031-2107-0	C8	CAP,ELEC,RAD,107, 20%, 50V	UNITED CHEMI-CON	SMG50VB101M8X11LL	1
031-2106-0	C1 C4	CAP,ELEC,RAD, 106, 20%, 50V	UNITED CHEMI-CON	SMG50VB10RM5X11LL	2
031-2105-0	C15	CAP,ELEC,RAD, 105, 20%, 50V	UNITED CHEMI-CON	C440C105M5U5CA	1
035-8271-0	C11	CAP MICA RADIAL, 270pF, 5%, 300V	CORNELL	CD15FC271J103	1
031-2335-0	C3	CAP,ELEC,RAD,335,20%,50V	UNITED CHEMI-CON	SMG50VB3R3M5X11LL	1
031-1336-0	C12 C19	CAP,ELEC,RAD,336,20%,25V	UNITED CHEMI-CON	SRG25VB33RM5X7LL	2
035-8030-0	C13	CAP MICA AXIAL , 3pF, 10%, 500V	CORNELL	CD10CD030D03	1
031-4475-0	C14 C17	CAP,EL-R,4.7UF/100V, M	UNITED CHEMI-CON	SMG100VB4R7M5X11LL	2
034-4471-0	C5	CAP,MCR,470pF,5%,100V,	TAITRON	TMRS471J100NPOB	1
031-4476-0	C22 C24	CAP,ELEC,RAD,476,-10%+50%,100V	UNITED CHEMI-CON	SMG100VB47R7M10X12LL	2
092-0001-0	J5	CON, IECX3, 10A, 250V, PC TERM	DIHTAIN	DTS-0045	1
092-0081-0	J8	JACK,1/4",MONO,PC,NON GROUNDING	NEUTRIK	S102-84	1
092-0082-0	J9-10	JACK,1/4",MONO,PC, GROUNDING	NEUTRIK	S102-84G	2
092-0066-0	T1-10	FASTON, M, PC, .250"	KEYSTONE	1021	10
020-2106-0	D14-15	1N4004,RECT,1A,400V,DO-41	TAITRON	1N4004	2
020-1000-0	D1 D7 D10-11	1N4148, RECT-FAST, 200MA, 100V	MOTOROLA	1N4148	4
020-1104-0	D13	SHOTTKY, 1A, 40V, 10NS, DO-41	MOTOROLA	1N5819	1
020-0036-0	D3 D5	1N747A, ZENER, 3.6V, 5%, 400MW, DO-35	TAITRON	1N747A	2
020-0050-0	D12	1N751, ZENER,5.1V,10%,400MW,DO-35	NATIONAL	1N751	1
020-0004-0	D2	1N755A, ZENER,7.5V,500MW ,D035	TAITRON	1N755A	1
020-1022-0	D4 D6	BAV20, RECT, 200V, DO-35	NATIONAL	BAV20	2
023-0005-0	BR1-3	BRIDGE, 4A, 100V, VERT, PC	TAITRON	TU401	3
020-1120-0	D8-9	MUR120,RECT-FAST, 1A, 200V, 25NS, 59-04	MOTOROLA	MUR120	2
020-1122-0	D16-17	MUR410, RECT-FAST, 4A, 100V	MOTOROLA	MUR410	2
091-0012-0	F1	FUSE,5mm,T3.15AL,250V,SEMKO	LITTLE FUSE	218-3.15	1
094-0004-0	J6	FUSE CLIP, 5MM, 15A, P.C.	MOUSER	44FH052	1
091-1001-0	S1	THRM BRKR, 85C +/-5,0-DIFF, PC	KLIXON	7AM-024-A5	1
093-1011-0	J4	HDR,.156X2,VERT,MALE,LOCK,SQUARE	MOLEX	26-60-4020	1
093-1010-0	J7	HDR,.156X7,VERT,MALE,LOCK,SQUARE	MOLEX	26-60-4070	1
093-0025-0	J3	HDR,.1X2,VERT,MALE,LOCK,GOLD	AMP	641126-2	1
093-0043-0	J1	HDR, 2MMX3, VERT, LOCK	JST	B3B-PH-K-S	1
093-2005-0	J2	HDR, 2MMX7, VERT, SHROUDED	JST	B7B-PH-K-S	1
014-0070-0	Q13	LM317	NATIONAL	LM317	1
014-1072-0	Q12	LM337	NATIONAL	LM337	1
001-2060-0	U1	LM555, TIMER	NATIONAL	LM555CN	1
081-0055-0	L1	INDUCTOR,2UH,20A,AIR CORE	SCHONBERG	081-0055-0	1
000-0000-0	X1	.125 HOLE, NON-PLATED			1
070-0520-0	R35	POT,500B TRIM, 200mW	SONG HUEI	SH-655MCL-500B	1
055-.220-0	R39-44 R47-48	RES, METAL OXIDE, 0.22 Ohm, 2W, 5%	ECI	MOM20J3AJ000.22	8
059-1002-0	R26 R28	RES,MF,FUSE,1.00K,1/4W,1%	JUKN.OHM	FR25-1.00K	2
059-1002-0	R56	RES,MF,FUSE, 1.00K, 1/4W, 1%	JUKN.OHM	FR25-1.00K	1
060-1002-0	R11 R24 R36 R50-51 R53	RES,METAL FILM, 1.00K, 1/8W, 1%	ECI	M1F1AK001.00	6
056-0100-0	R54	RES, CERAMIC WW, 1.0, 5W, 10%	ECI	WWC50J3AJ001.00	1
060-1212-0	R59	RES,METAL FILM, 1.21K, 1/8W, 1%	ECI	M1F1AK001.21	1
060-1003-0	R6 R31	RES,METAL FILM, 10.0K, 1/8W,1%	ECI	M1F1AK010.00	2
059-1000-0	R57-58	RES,MF,FUSE,10.0 OHM, 1/4W,1%	JUKN.OHM	FR25-10.0	2
060-1004-0	R19 R33	RES,METAL FILM, 100K, 1/8W, 1%	ECI	M1F1AK100.00	2
055-0101-0	R46 R49	RES, METAL OXIDE, 10 OHM, 2W, 5%	ECI	MOM20J3AJ010.00	2
060-1213-0	R13 R23	RES,METAL FILM, 12.1K OHM, 1/8W, 1%	ECI	M1F1AK012.10	2
060-1821-0	R18 R21 R32	RES,METAL FILM, 182, 1/8W, 1%	ECI	M1F1AJ182.00	3
060-2002-0	R17 R20 R29 R37	RES,METAL FILM, 2.00K, 1/8W, 1%	ECI	M1F1AK002.00	4
052-2212-0	R5 R8	RES,METAL FILM,2.21k,1/4W,1%	ECI	M2F1AK002.21	2
060-2432-0	R1 R10 R55	RES,METAL FILM, 2.43K, 1/8W, 1%	ECI	M1F1AK002.43	3
055-2702-0	R60-61	RES, METAL OXIDE, 2.7K OHM, 2W, 5%	ECI	MOM20J3AK002.70	2
060-2004-0	R9	RES,METAL FILM, 200K, 1/8W, 1%	ECI	M1F1AK200.00	1
061-2213-0	R15	RES ,METAL FILM,22.1K,1/2W,1%	ECI	M5F1AK022.10	1
060-2431-0	R2 R12	RES,METAL FILM, 243 Ohm, 1/8W, 1%	ECI	M1F1AJ243.00	2
060-3922-0	R34	RES,METAL FILM, 3.92K, 1/8W, 1%	ECI	M1F1AK003.92	1
060-4752-0	R3	RES,METAL FILM, 4.75K, 1/8W, 1%	ECI	M1F1AK004.75	1
060-4323-0	R30	RES,METAL FILM, 43.2K, 1/8W, 1%	ECI	M1F1AK043.20	1
060-4753-0	R14 R52	RES,METAL FILM, 47.5K, 1/8W, 1%	ECI	M1F1AK047.50	2

Customer Name:		Gallien-Krueger		Current Rev #:		A6		New ECO Rev #:		A7	
Model:		MB150-III		Distribute To:				Page:		1 Of: 1	
Assembly Description:		Power Amp		Originator:		Enrique Hernandez					
Assembly Numbers:		206-0211-A		Approved by:							
		145-0211-A		Effective Date:		9/3/2004					
Effective				Document Update				Date		Initials	
<input checked="" type="checkbox"/>	All in Process	<input checked="" type="checkbox"/>	Next Buy	<input type="checkbox"/>	Artwork						
<input checked="" type="checkbox"/>	All in Service	<input checked="" type="checkbox"/>	Next Production Run	<input type="checkbox"/>	Assembly Dwg.						
<input type="checkbox"/>	All in Stock	<input type="checkbox"/>		<input type="checkbox"/>	Board Artwork						
Beginning Serial Number:				<input checked="" type="checkbox"/>	BOM						Noli
Reason For Change				<input type="checkbox"/>	Control Form						
Resistors R39 through R44, R47, and R48 moved to the solder side of the power amp board, with insulator in between the resistors and the power amp board. Also, insulator placed on the heatsink, where the above mentioned resistors will lie.				<input type="checkbox"/>	Costing						
				<input type="checkbox"/>	Fab Drawing						
				<input type="checkbox"/>	Inspection Proc.						
				<input checked="" type="checkbox"/>	Part Master File						Noli
				<input checked="" type="checkbox"/>	Schematic						Noli
				<input type="checkbox"/>	Service Manual						
				<input type="checkbox"/>	Test Procedure						
				<input type="checkbox"/>							
				Other Affected Assemblies							
				302 Assemblies, 303 Assemblies							
<input type="checkbox"/>	Continued on ECO Supplement Page										
Description Of Change				Distribution				Date		Initials	
				<input type="checkbox"/>	Accounting						
				<input type="checkbox"/>	Assembly						
Update part master file.				<input checked="" type="checkbox"/>	Engineering						
				<input checked="" type="checkbox"/>	Incoming Q.C.						
Update BOM.				<input checked="" type="checkbox"/>	Production Eng.						
				<input checked="" type="checkbox"/>	Purchasing						
PCB layout remains the same.				<input type="checkbox"/>	Q.A.						
				<input checked="" type="checkbox"/>	Service						
				<input checked="" type="checkbox"/>	Test						
<input type="checkbox"/>	Continued on Supplement Page			<input checked="" type="checkbox"/>	Drawing(s) attached						
Part Number	Description	Parts Added		Parts Deleted							
		Qty	Ref. Designator	Qty	Ref. Designator						
023-0005-0	4A Bridge Rect.			1	BR3						
023-0004-0	8A Bridge Rect.	1	BR3								

1 2 3 4 5 6

REVISION RECORD	
LTR	ECO NO
ECO NO	APPROVED
DATE	DATE
	8/03/04

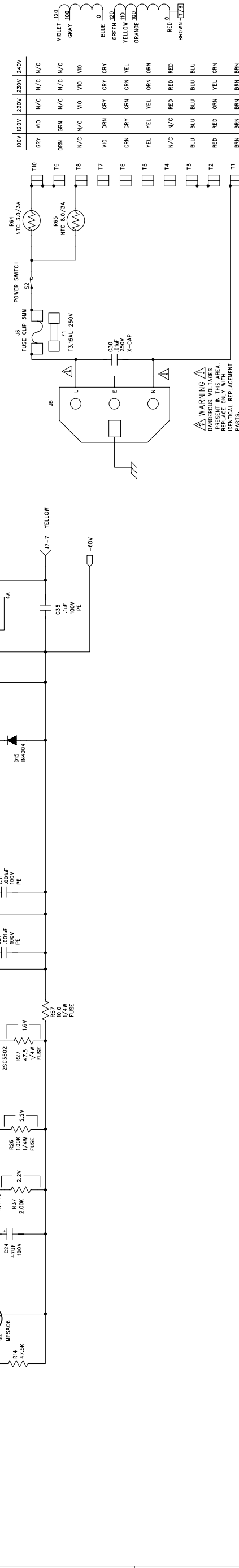
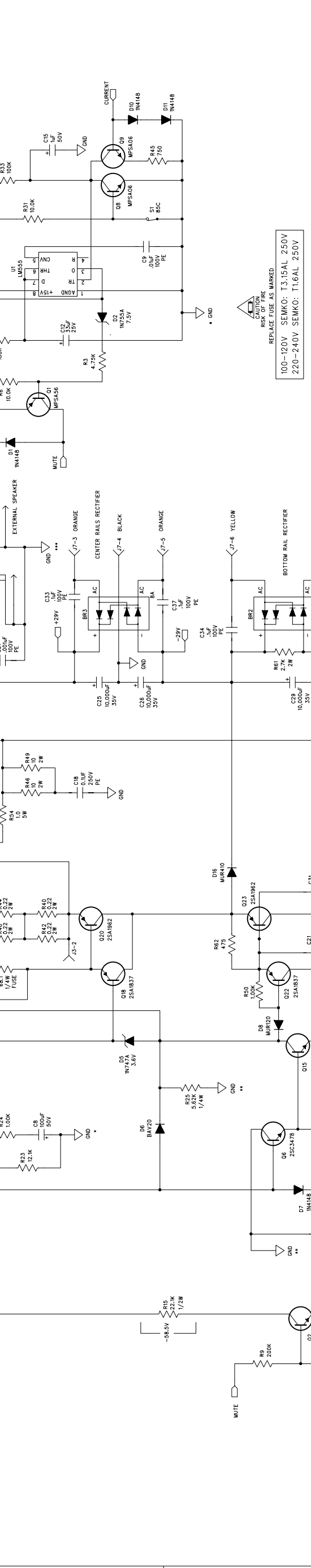
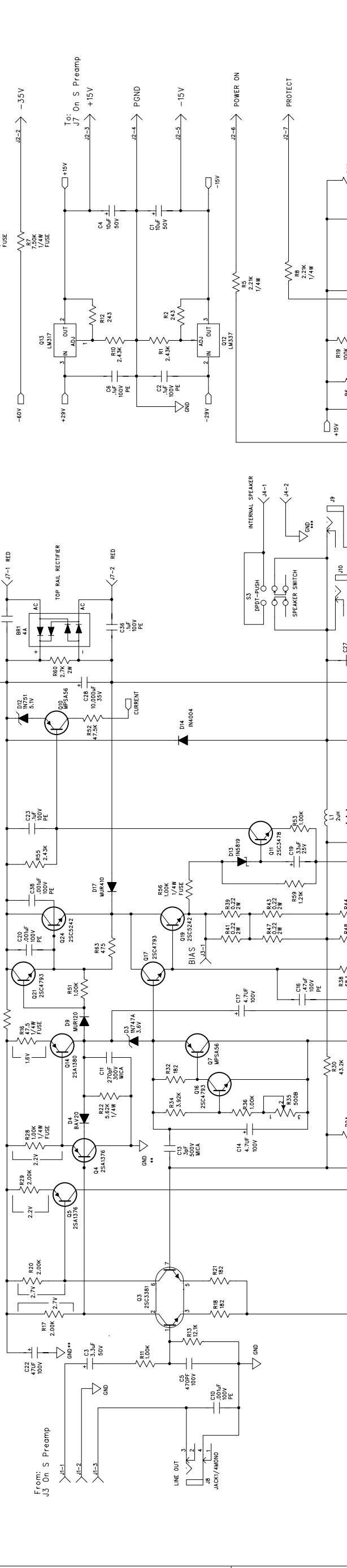

WARNING
DANGEROUS VOLTAGES PRESENT IN THIS AREA. REPLACE ONE PART WITHOUT REPLACING THE ENTIRE PARTS.

REPLACE FUSE AS MARKED
RISK OF FIRE
100-120V SEMKO: T3.15AL 250V
220-240V SEMKO: T1.6AL 250V

100V	120V	220V	230V	240V
GRY	VD	N/C	N/C	N/C
GRN	GRN	N/C	N/C	N/C
N/C	N/C	VD	VD	VD
VD	VD	DRN	GRY	GRY
GRN	GRN	GRN	GRN	YEL
YEL	YEL	YEL	YEL	DRN
N/C	N/C	N/C	RED	RED
BLU	BLU	BLU	BLU	BLU
RED	RED	DRN	DRN	BRN
BRN	BRN	BRN	BRN	BRN

TO TOP RAIL RECTIFIER
TO CENTER RAILS RECTIFIER
TO BOTTOM RAIL RECTIFIER

NOT VALID UNLESS STAMP IS RED

BIAS ADJUSTMENT PROCEDURE
WITH POWER OFF, ADJUST POT R35 TO FULL COUNTER-CLOCKWISE POSITION.
TURN ON POWER AND WAIT 5 SECONDS FOR TURN ON DELAY.
TURN R35 CLOCKWISE UNTIL VOLTAGE ACROSS J5 READS 10 mVDC.

gallen technology

APPROVALS	
INIT	DATE
DESIGNED: R.A.C.	2/28/01
DRAWN: NOLI	9/07/04
ELEC:	
MECH:	
G/A:	
RELEASED:	

NOTES TO REV A7:
1. Mount R39 to R44, R47 and R48 to solder
2. Replace BR1 with BR bridge rect.
3. Update board number to 206-0211-A7.

TITLE: MB150-III POWER AMP
DRAWING NO: 406-0211-A7
PART NO: 206-0211-A7
COMPANY: GALLIEN-KRUEGER
FILENAME: 6211A6.sch

2234 INDUSTRIAL DRIVE
STOCKTON CA. 95206
VOICE: 209-234-7300
FAX: 209-234-8420

GALLIEN-KRUEGER

MB150-III Power Amp		Costed Bill Of Material		206-0211-A7	
Part No.	Reference	Description	Manufacturer	Mfr. Part No.	Quan
032-4102-0	C10 C20-21 C27 C31 C38	CAP,PE,102,5%,100V,	PANASONIC	ECQB1102JF	6
032-4103-0	C9	CAP,PE,103,5%,100V,	PANASONIC	ECQV1103JM	1
034-7103-0	C30	CAP, CERMIC DISK, 103, 10%, X-250V	PANASONIC	ECK-DRS103ZV	1
032-4104-0	C2 C6 C23 C32-37	CAP,PE,104,5%,100V,	PANASONIC	ECQV1104JM	9
032-7104-0	C18	CAP,PE,104,10%, 250V	ILLINOIS CAPACITOR	104MSR250K	1
032-4474-0	C16	CAP,PE,474,5%,100V,	PANASONIC	ECQV1474JM	1
031-2109-1	C25-26 C28-29	CAP, ELEC, RAD, 10,000uF, -10% +50%, 35V	UNITED CHEMICON	SMH35VN103M30x30T2	4
031-2107-0	C8	CAP,ELEC,RAD,107, 20%, 50V	UNITED CHEMI-CON	SMG50VB101M8X11LL	1
031-2106-0	C1 C4	CAP,ELEC,RAD, 106, 20%, 50V	UNITED CHEMI-CON	SMG50VB10RM5X11LL	2
031-2105-0	C15	CAP,ELEC,RAD, 105, 20%, 50V	UNITED CHEMI-CON	C440C105M5U5CA	1
035-8271-0	C11	CAP MICA RADIAL, 270pF, 5%, 300V	CORNELL	CD15FC271J103	1
031-2335-0	C3	CAP,ELEC,RAD,335,20%,50V	UNITED CHEMI-CON	SMG50VB3R3M5X11LL	1
031-1336-0	C12 C19	CAP,ELEC,RAD,336,20%,25V	UNITED CHEMI-CON	SRG25VB33RM5X7LL	2
035-8030-0	C13	CAP MICA AXIAL, 3pF, 10%, 500V	CORNELL	CD10CD030D03	1
031-4475-0	C14 C17	CAP,EL-R,4.7UF/100V, M	UNITED CHEMI-CON	SMG100VB4R7M5X11LL	2
034-4471-0	C5	CAP,MCR,470pF,5%,100V,	TAITRON	TMR5471J100NPOB	1
031-4476-0	C22 C24	CAP,ELEC,RAD,476,-10%+50%,100V	UNITED CHEMI-CON	SMG100VB47RM10X12LL	2
092-0001-0	J5	CON, IECX3, 10A, 250V, PC TERM	DIHTAIN	DTS-0045	1
092-0081-0	J8	JACK,1/4",MONO,PC,NON GROUNDING	NEUTRIK	S102-84	1
092-0082-0	J9-10	JACK,1/4",MONO,PC, GROUNDING	NEUTRIK	S102-84G	2
092-0066-0	T1-10	FASTON, M, PC, .250"	KEYSTONE		1021 10
020-2106-0	D14-15	1N4004,RECT,1A,400V,DO-41	TAITRON	1N4004	2
020-1000-0	D1 D7 D10-11	1N4148, RECT-FAST, 200MA, 100V	MOTOROLA	1N4148	4
020-1104-0	D13	SHOTTKY, 1A, 40V, 10NS, DO-41	MOTOROLA	1N5819	1
020-0036-0	D3 D5	1N747A, ZENER, 3.6V, 5%, 400MW, DO-35	TAITRON	1N747A	2
020-0050-0	D12	1N751, ZENER,5.1V,10%,400MW,DO-35	NATIONAL	1N751	1
020-0004-0	D2	1N755A, ZENER,7.5V,500MW ,D035	TAITRON	1N755A	1
020-1022-0	D4 D6	BAV20, RECT, 200V, DO-35	NATIONAL	BAV20	2
023-0005-0	BR1-2	BRIDGE, 4A, 100V, VERT, PC	TAITRON	TU401	2
023-0004-0	BR3	BRIDGE, 8A, 200V, VERT, PC	TAITRON	TU401	1
020-1120-0	D8-9	MUR120,RECT-FAST, 1A, 200V, 25NS, 59-04	MOTOROLA	MUR120	2
020-1122-0	D16-17	MUR410, RECT-FAST, 4A, 100V	MOTOROLA	MUR410	2
091-0012-0	F1	FUSE,5mm,T3.15AL,250V,SEMKO	LITTLE FUSE	218-3.15	1
094-0004-0	J6	FUSE CLIP, 5MM, 15A, P.C.	MOUSER	44FH052	1
091-1001-0	S1	THRM BRKR, 85C +/-5,0-DIFF, PC	KLIXON	7AM-024-A5	1
093-1011-0	J4	HDR,.156X2,VERT,MALE,LOCK,SQUARE	MOLEX	26-60-4020	1
093-1010-0	J7	HDR,.156X7,VERT,MALE,LOCK,SQUARE	MOLEX	26-60-4070	1
093-0025-0	J3	HDR,.1X2,VERT,MALE,LOCK,GOLD	AMP	641126-2	1
093-0043-0	J1	HDR, 2MMX3, VERT, LOCK	JST	B3B-PH-K-S	1
093-2005-0	J2	HDR, 2MMX7, VERT, SHROUDED	JST	B7B-PH-K-S	1
014-0070-0	Q13	LM317	NATIONAL	LM317	1
014-1072-0	Q12	LM337	NATIONAL	LM337	1
001-2060-0	U1	LM555, TIMER	NATIONAL	LM555CN	1
081-0055-0	L1	INDUCTOR,2UH,20A,AIR CORE	SCHONBERG	081-0055-0	1
000-0000-0	X1	.125 HOLE, NON-PLATED			1
070-0520-0	R35	POT,500B TRIM, 200mW	SONG HUEI	SH-655MCL-500B	1
055-220-0	R39-44 R47-48	RES, METAL OXIDE, 0.22 Ohm, 2W, 5%	ECI	MOM20J3AJ000.22	8
059-1002-0	R26 R28	RES,MF,FUSE,1.00K,1/4W,1%	JUKN.OHM	FR25-1.00K	2
059-1002-0	R56	RES,MF,FUSE, 1.00K, 1/4W, 1%	JUKN.OHM	FR25-1.00K	1
060-1002-0	R11 R24 R36 R50-51 R53	RES,METAL FILM, 1.00K, 1/8W, 1%	ECI	M1F1AK001.00	6
056-0100-0	R54	RES, CERAMIC WW, 1.0, 5W, 10%	ECI	WWC50J3AJ001.00	1
060-1212-0	R59	RES,METAL FILM, 1.21K, 1/8W, 1%	ECI	M1F1AK001.21	1
060-1003-0	R6 R31	RES,METAL FILM, 10.0K, 1/8W,1%	ECI	M1F1AK010.00	2
059-1000-0	R57-58	RES,MF,FUSE,10.0 OHM, 1/4W,1%	JUKN.OHM	FR25-10.0	2
060-1004-0	R19 R33	RES,METAL FILM, 100K, 1/8W, 1%	ECI	M1F1AK100.00	2
055-0101-0	R46 R49	RES, METAL OXIDE, 10 OHM, 2W, 5%	ECI	MOM20J3AJ010.00	2
060-1213-0	R13 R23	RES,METAL FILM, 12.1K OHM, 1/8W, 1%	ECI	M1F1AK012.10	2
060-1821-0	R18 R21 R32	RES,METAL FILM, 182, 1/8W, 1%	ECI	M1F1AJ182.00	3
060-2002-0	R17 R20 R29 R37	RES,METAL FILM, 2.00K, 1/8W, 1%	ECI	M1F1AK002.00	4
052-2212-0	R5 R8	RES,METAL FILM,2.21k,1/4W,1%	ECI	M2F1AK002.21	2
060-2432-0	R1 R10 R55	RES,METAL FILM, 2.43K, 1/8W, 1%	ECI	M1F1AK002.43	3
055-2702-0	R60-61	RES, METAL OXIDE, 2.7K OHM, 2W, 5%	ECI	MOM20J3AK002.70	2
060-2004-0	R9	RES,METAL FILM, 200K, 1/8W, 1%	ECI	M1F1AK200.00	1
061-2213-0	R15	RES ,METAL FILM,22.1K,1/2W,1%	ECI	M5F1AK022.10	1
060-2431-0	R2 R12	RES,METAL FILM, 243 Ohm, 1/8W, 1%	ECI	M1F1AJ243.00	2
060-3922-0	R34	RES,METAL FILM, 3.92K, 1/8W, 1%	ECI	M1F1AK003.92	1
060-4752-0	R3	RES,METAL FILM, 4.75K, 1/8W, 1%	ECI	M1F1AK004.75	1
060-4323-0	R30	RES,METAL FILM, 43.2K, 1/8W, 1%	ECI	M1F1AK043.20	1

MB150-III Power Amp		Costed Bill Of Material		206-0211-A7	
Part No.	Reference	Description	Manufacturer	Mfr. Part No.	Quan
060-4753-0	R14 R52	RES,METAL FILM,47.5K, 1/8W, 1%	ECI	M1F1AK047.50	2
059-4750-0	R16 R27	RES,MF,FUSE,47.5 OHM, 1/4W,1%	JUKN.OHM	FR25-47.5	2
060-4751-0	R62-63	RES,METAL FILM, 475 ohm, 1/8W, 1%	ECI	M1F1AJ475.00	2
052-5622-0	R22 R25	RES,METAL FILM,5.62K,1/4W,1%	ECI	M5F1AK005.62	2
059-5622-0	R4	RES,MF,FUSE, 5.62K, 1/4W, 1%	JUKN.OHM	FR25-5.62K	1
059-6810-0	R38	RES,MF,FUSE,68.1 OHM, 1/4W,1%	JUKN.OHM	FR25-68.1	1
059-7502-0	R7	RES,MF,FUSE, 7.50K, 1/4W, 1%	JUKN.OHM	FR25-7.50K	1
060-7501-0	R45	RES,METAL FILM, 750 OHM, 1/8W, 1%	ECI	M1F1AJ750.00	1
090-0014-0	S3	SWITCH,PP,DPDT,.5A,BREAK/MAKE,PC MOUNT	E-SWITCH	LTBP2UEE-CAU	1
090-0007-0	S2	SWITCH, 8A/128A,250V,PP,PCB	TECX	KDC-A04-10-B, B2-F	1
022-3010-0	R64	THERMISTOR, NTC 3.0 OHM, 3AMP	UEI	08SP003M	1
022-3015-0	R65	THERMISTOR, NTC 8.0 OHM, 3AMP	UEI	08SP008M	1
010-1002-0	Q4-5	2SA1376, PNP,180V,100MA,TO-92	NEC	2SA1376-K	2
010-1003-0	Q14	2SA1380-F,PNP,200V,100MA,TO-126	SANYO/TOSHIBA	2SA1380-F/E	1
012-1002-0	Q18 Q22	2SA1837,PNP,200V,1.5A,2-10R1A	TOSHIBA	2SA1837	2
012-1003-0	Q20 Q23	2SA1962,PNP,230V,15A,2-16C1A	TOSHIBA	2SA1962	2
010-0000-0	Q3	2SC3381BL,NPNX2,80V,100MA,2-10M1B	TOSHIBA	2SC3281BL	1
010-0001-0	Q6 Q11	2SC3478, NPN,180V,100MA,TO-92	NEC	2SC3478-K	2
010-0003-0	Q15	2SC3502-F,NPN,200V,100MA,TO-126	TOSHIBA	2SC3502	1
012-0002-0	Q16-17 Q21	2SC4793,NPN,200V,1.5A,2-10R1A	TOSHIBA	2SC4793	3
012-0003-0	Q19 Q24	2SC5242,NPN,230V,15A,2-16C1A	TOSHIBA	2SC5242-O	2
010-0012-0	Q2 Q8-9	MPSA06, NPN,80V,500MA,TO-92	MOTOROLA	MPS-A06	3
010-1013-0	Q1 Q7 Q10	MPSA56 PNP 80V 500MA TO-92	MOTOROLA	MPS-A56	3