

SCHEMATIC DIAGRAM

AC15VR Preamp

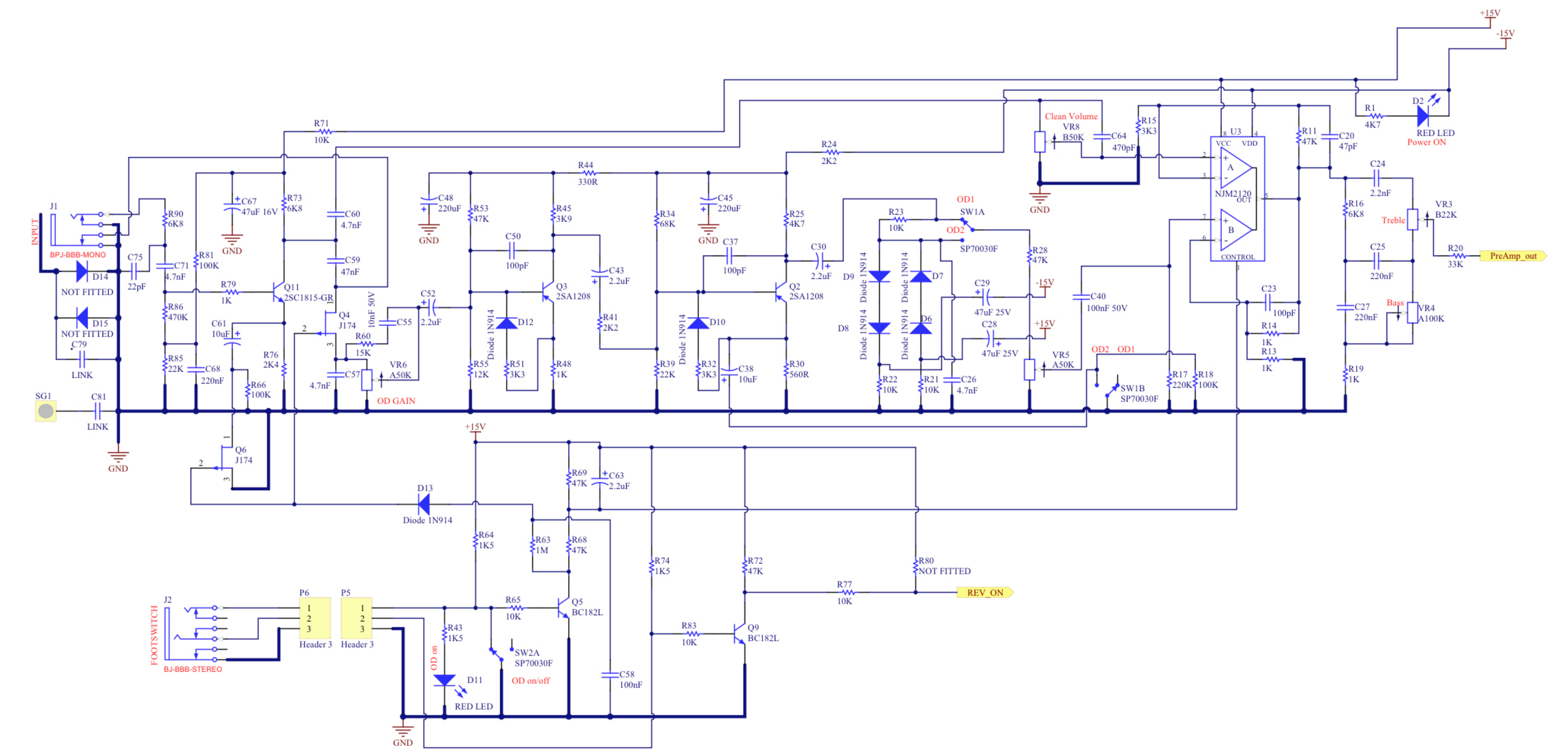

SCHEMATIC DIAGRAM

AC15VR Power Stage

