

Acoustic 260, 261 & 262 Service Manual

Note: The 160 was similar, I think it used a 150 series 17-10 preamp board for channel A and the full 260 preamp chain (variamp main pre, fuzz & reverb/tremolo boards) for Channel B, the power sections were the same.

260 SERIES AMPLIFIERS—FOR THE MUSICIAN WHO NEEDS MAXIMUM VERSATILITY

model 262

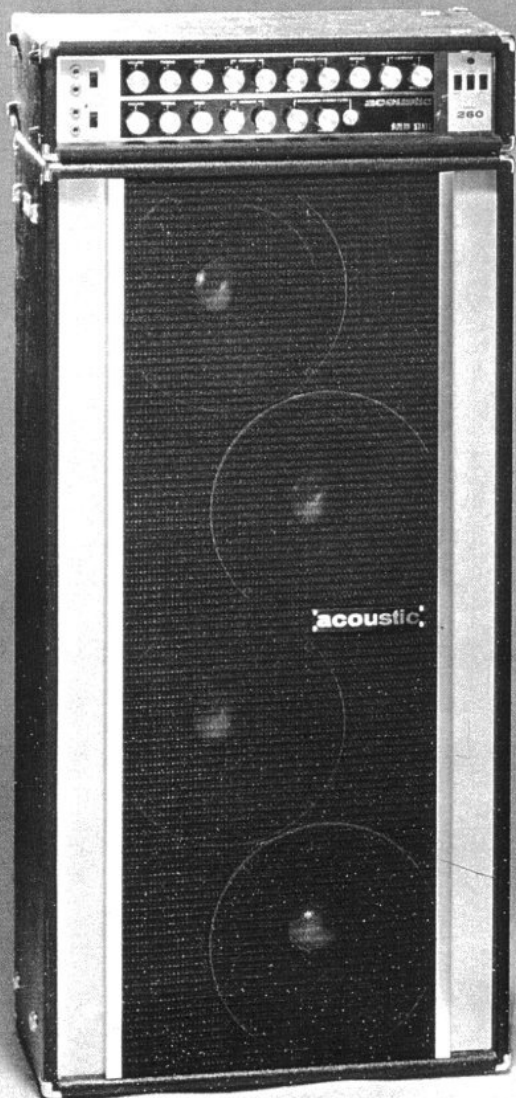

model 261

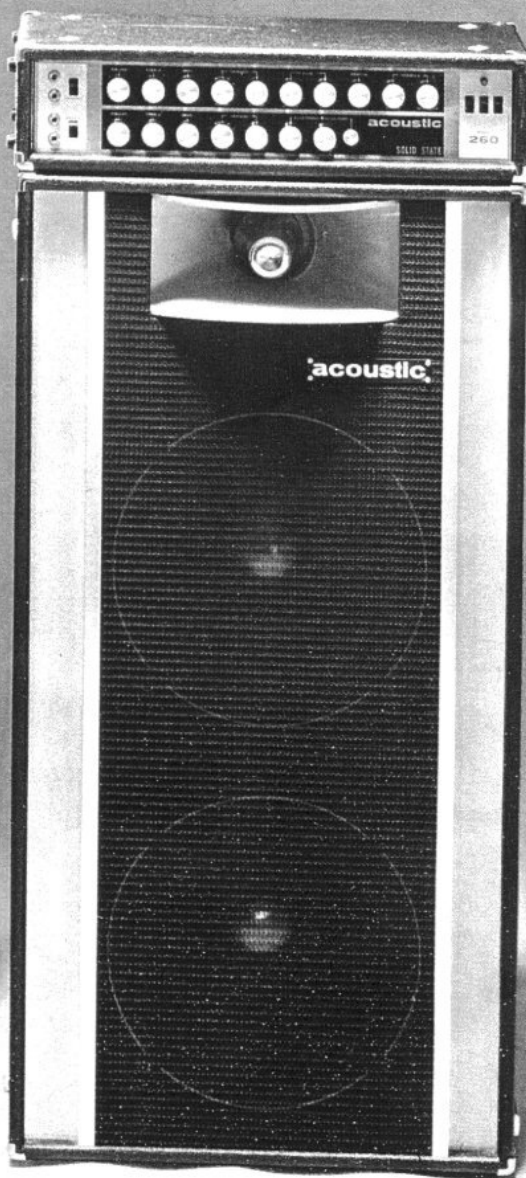

260 SERIES AMPLIFIERS—275 WATTS OF PORTABLE POWER WITH THE SOUND FACILITIES OF A RECORDING STUDIO.

Our 260 series amplifiers provide the special effects and sounds previously available only in a recording studio.

Variamp controls provide full spectrum tone control (range and amount).

Fuzz controls select both attack (type) and gain (amount).

Special effects channel also includes reverb and tremolo controls.

Two channels may be combined or separated with stereo/mono switch. Each channel output available for monitor or additional amplifiers.

Five octave built-in oscillator.

AGC control may be switched in to prevent bass distortion and overload.



Model 261 includes a high-compression, fiberglass horn and two 15" Altec Lansing speakers. This combination provides full rich tones plus unequalled clarity.



Model 262 includes four 12" Altec Lansing speakers and is particularly suited for blues players.

Our rugged speaker cabinets deliver the full power from the amplifier

- We use $\frac{3}{4}$ inch plywood throughout with tongue and groove construction to eliminate rattles.

- Speakers are front mounted, allowing permanent, rigid back construction.

- The front cover is a snap-off grill cloth.

SPECIFICATIONS

Power Output

RMS Continuous 125 Watts

Peak Music Power 275 Watts

Preamplifier Gain x40 (high gain input)

Signal-to-noise ratio 80 db

Inputs 4 (high gain and low gain for each channel)

Output Jacks

Auxiliary Power 1—110 VAC outlets

Speakers 1 (4 ohm output)

Booster Output 2 (one per channel, for use with Model 200 power amplifier and extra speaker system.)

Footswitch Electronic tuning fork, Tremolo, Reverb, Fuzz

Controls

Channel 1 Volume, Treble, Bass, Bright Switch, Variamp Range and Effect, Fuzz Attack and Gain, Reverb, Tremolo Speed and Intensity

Channel 2 Volume, Treble, Bass, Bright Switch, Variamp Range and Effect

Electronic Tuning Fork Fine, coarse, on/off switch

Power On/off and ground reverse switch

Special Controls AGC on/off switch, speaker on/off switch, stereo/mono switch

Overall size (including top) 54" high by 24" wide by 12" deep

Weight (including top)

261 145 lbs

262 175 lbs

ACOUSTIC SERVICE MANUAL

Model 260

	Page
I. General Information	1
A. Description	1
B. Specifications	1
II. Theory of Operations	1
III. General Troubleshooting	2
A. Equipment Required	2
B. Preliminary Checks	2
C. Detailed Testing and Voltage Tables	3
D. Adjustments	16
IV. Schematic Diagrams and Illustrations	
A. Complete Schematic	17
B. Pre Amp P.C. Board Photo 17-1B	18
C. Pre Amp P.C. Board Photo 17-1B	19
D. Pre Amp P.C. Board Photo 17-1B with Triridge Relay	20
E. Pre Amp P.C. Board Photo 17-1B with Triridge Relay	21
F. Pre Amp P.C. Board Photo 17-1C	22
G. Pre Amp P.C. Board Photo 17-1C	23
H. Fuzz P.C. Board Photo 17-2	24
I. Reverb Tremelo Photo 17-3	25
J. E.T.F. Electronic Tuning Fork 17-4	26
K. Power P.C. Board Photo 17-5	27
L. Power P.C. Board Photo 17-5	28
V. Control Locations	30
VI. Speaker and Network Wiring	31
VII. Troubleshooting Chart	32
VIII. Parts List	33
IX. Specifications	37

I. GENERAL INFORMATION

A. Description

The model 261 consists of two pieces. The electronics are contained in one cabinet while the speaker system is in a separate cabinet. The system is designed for use as a guitar amplifier. A separate panel with foot switches is provided for remote control of the various functions available.

B. Specifications

The unit is rated at 125W RMS power output. The speaker system contains 2-15" speakers and a high frequency horn mounted in an infinite baffle configuration. Features are:

- Channel A & Channel B — Hi & Lo gain inputs, bright switch, volume, treble and bass; variamp.
- Channel A — Fuzz, reverb, tremolo
- Channel B — Electronic tuning jack. Stereo/mono switching, automatic gain control.

II. THEORY OF OPERATION

For the following discussion it will be necessary to refer to the schematic diagram DWG No. 1004A on Page 17. The preamplifier sections proper are essentially the same for both channels, up to the emitter followers Q6A and Q6B. Beginning with Channel A, Q1A is an emitter follower providing high input impedance and unity gain. Q1A in this channel not only drives Q2A when the reed relay is in the position shown but drives also the reverb circuitry. Q2A is a variable gain amplifier stage with R7A, connected in a feedback arrangement, providing the gain control. Q3A is an emitter follower acting as a buffer for Q2A. Q3A drives the reverb circuitry. The direct signal returns from the reverb circuitry to the base of Q4A at the same level as at the emitter of Q3A (providing R67 is adjusted correctly). Q4A provides some gain and drives the tone control circuitry. Q5A provides a gain of 2 at all frequencies when R24A is in the midposition. When R24 is fully clockwise, the emitter of Q5A is shunted to ground for the band of frequencies determined by the series resonant circuit L1A and the particular capacitor selected by S4A. For this band of frequency the gain of Q5A is increased. See tables in the section on detailed testing for the proper frequencies, Page 4. When R24A is fully counter-clockwise, the collector of Q5A is shunted to ground for the band of frequencies selected as before. Under this condition the gain of Q5A is greatly reduced only for that particular band of frequencies. This is the "VARIAMP" effect and provides interesting tonal combinations. Q6A is again an emitter follower. R29A is mechanically ganged to R7A. This is done to reduce circuit noise at low levels.

- 1) Fuzz Section — Q7 is a reverse biased transistor which behaves as a zener diode to keep the supply for Q8 and Q9 from variations. Q8 and Q9 are connected as a low dynamic range, overdriven amplifier. Q8 is somewhat overdriven while Q9 is greatly overdriven. This causes a distortion of the signal resulting in the "fuzz" sound. R40 determines the mixture of signal fed to Q10 via R41. When the wiper of R40 is at the lower end of R40, the signal all comes from Q8 which introduces much less distortion than Q9 and hence a less raspy sound. The reed relay determines whether or not Q4A is driven with the fuzz signal or the clean signal directly from Q3A. The relay is activated by a foot switch and the switch S5 which is mechanically ganged to R41. Q10 is an emitter follower.

- 2) Reverb Section – Q11 thru Q16 comprise the reverb section. Q1 is driven from Q3A and is an emitter follower which provides a source of low impedance drive for Q12. Q12 operates at a fairly high current and drives the input coil of the reverb delay spring. Q13 is driven by the pickup coil on the spring and amplifies this signal while driving Q14. Q14 further amplifies the reverb signal. The reverb is cut off by the foot switch which grounds the junction of C35 and C37. When the wiper of R59 is at the lower end, Q15 receives signal directly from Q3A. Q15 drives Q16 which has a gain of one. Q15 also has a gain of unity when the resistance of the tremolo LDR is correct. This is set by adjusting R67. As R59 is moved upward, progressively more of the delayed signal is added to Q15 and less direct signal.
- 3) Tremolo Section – Q17 thru Q19 constitute the tremolo section along with the LDR cell. Q19 is a phase shift oscillator operating at the tremolo rate set by R73. Q17 and Q18 are connected as a Darlington emitter follower providing sufficient current gain to operate the lamp bulb inside the cell. The low frequency oscillator signal causes the bulb to flicker in intensity by an amount set by R69. This in turn causes the light dependent resistor (LDR) to vary its resistance causing the gain of Q14 to vary. This is the tremolo effect.
- 4) ETF Section – Q22 is a junction transistor in an oscillator circuit. The frequency is determined by the settings of R78 and R79 and C51. The supply voltage for the oscillator is held constant by Q20 and Q21 connected as zeners. R81 limits the current when the foot switch grounds its lower end. The oscillator wave is filtered by R75, R76 and C49. The filtered signal is applied to the input by Channel B preamp via R75. R75 also isolates the ETF circuitry from the input of the preamp when the ETF is de-activated.
- 5) Regulator Section - +25V – Q30, Q31 and Q38 are connected as a voltage regulator supplying +25V to the preamp circuits. Q38 is connected as a zener diode and acts as the reference for the regulator. Q30 compares a portion of the +25V with the reference and thus develops a current with sufficient gain to adjust the conduction of Q31, the series pass element.
- 6) Power Amplifier – The signals of both channels are added together by R84 and R85 and amplified by the preamp formed by Q23 and Q24. The gain of Q23 is two when the AGC is inoperative. Q24 has unity gain always and acts only as an inverter. Q34 and Q36 are output transistors which conduct during the positive signal excursions while Q35 and Q37 conduct during negative signal excursions. Q32 and Q33 are drivers. Q26 is the input amplifier. D5 thru D9 are drive current limiters as are D3 and D4. On the positive amplifier output signal peaks, just before clipping, Q28 and Q29 conduct as does D2. This signal is stored in C58 and acts as bias voltage for the field effect transistor Q25. The bias so developed tends to turn off Q25 causing a reduction in gain of stage Q23. This is how AGC action is effected. The AGC has a dynamic range of two-to-one, or 6 db.

III. GENERAL TROUBLESHOOTING

A. Equipment Required

- 1) FET VM or VTVM.
- 2) VDM with 20 K/V D.C. rating.
- 3) 5 amp variac with line voltage meter.

4) Audio signal generator with output level control and calibrated frequency dial.

5) Oscilloscope with good sync capability and calibrated vertical amplifier.

B. Preliminary Checks

It is often difficult to establish meaningful communication between the equipment user and the technically qualified man whose duty it is to effect the repair of the equipment. With this in mind, the repair technician should either have the customer actually demonstrate the problem or connect an instrument to the amplifier and determine the problem himself. Once it has been determined that the problem requires removal of the chassis, do so and give the chassis a thorough visual inspection. Keep in mind that you may find anything as someone may have been into the unit at a prior time.

C. Detailed Testing and Voltage Tables

The first measurements to make are the main supply voltages. Measure the positive end of C68. This should read +70V when the line = 120 VAC. Next measure the emitter of Q31. This should read +25V. If these are correct, apply signal from an audio generator to the input of Channel A-J1. Using the scope probe, trace the signal as indicated by the table following.

Conditions: Line = 120 VAC; Volume = full cw; bright sw-off
Treble and base = full ccw; input = 100 mvpp at 300 Hz.
Range = #1; effect-mid

(Note: All readings are given in peak-to-peak values throughout this manual.)

1) Preamp Section: (Table good for Channel B also)

Q	Collector	Base	Emitter
1A,B	0	97 mv	94 mv
2A,B	1.2V	92 mv	92 mv
3A,B	0	1.2V	1.2V
4A,B	4.7V	1.2V	1.2V
5A,B	800 mv	400 mv	400 mv
6A,B	0	800 mv	800 mv

- 2) Variamp Section (applies for both channels) – Conditions are the same as above. The center frequencies as defined by the LC resonant circuit may vary from unit to unit. To locate the exact center frequency for your particular unit, sweep the audio signal generators frequency above and below the frequency indicated in the table until a peak or dip in level is observed, depending on the position of the "EFFECT" control. Scope at Q6AE.

Range	Effect	Frequency	Level
#1	cw	100 Hz	2V
#1	ccw	100 Hz	30 mv
#2	cw	300 Hz	2V
#2	ccw	300 Hz	30 mv
#3	cw	600 Hz	2V
#3	ccw	600 Hz	40 mv
#4	cw	1200 Hz	1.8V
#4	ccw	1200 Hz	55 mv
#5	cw	2400 Hz	1.7V
#5	ccw	2400 Hz	120 mv

The control frequency response may be checked with the same setup conditions as defined above. The following table gives the frequencies and levels for the various tone control positions.

Treble and Bass = full cw

Test Point	Frequency	Level
Q5A Base	300 Hz	400 mv
Q5A Base	50 Hz	1.6V
Q5A Base	5 KHz	3.7V

Treble and Bass = full ccw

Q5A Base	300 Hz	310 mv
Q5A Base	50 Hz	240 mv
Q5A Base	5 KHz	380 mv

3) Bright Switch – Testing bright switch – all conditions remain the same. Test point is the emitter of Q3A. Adjust input level for 87 mv at Q3A emitter. Change bright switch to “BRIGHT” position and the level should increase to approximately 500 mv or +16 db.

4) Reverb Section

Conditions: Bass = ccw/treble = ccw/vol. cw
 Range = 1/effect = mid/reverb = ccw
 Bright sw = off Input = 60 mvpp at 1000 Hz
 Line = 120 VAC.

Using the oscilloscope, measure the signal levels at the points indicated in the following table and compare the data.

Q	Collector	Base	Emitter
11	48 mv (distorted)	0.65V	0.61V
12	20V	0.61V	0.55V
15	0.75V	0.68V	0.68V
16	0.68V*	0.75V	0.75V

* – this reading is contingent upon the setting of R67 in the tremolo circuitry. See theory of operation.

Reverb pickup amplifier. Apply a signal of 100 mv to the reverb spring phono plug at the end of the pickup shielded lead. Frequency = 1000 Hz.

Q	Collector	Base	Emitter
13	1.6V	100 mv	95 mv
14	6V	1.4V	1.4V

- 5) Tremolo Section – When the tremolo circuitry is operating correctly, waveforms will be as indicated in the following table.

Speed = ccw

Intensity = ccw

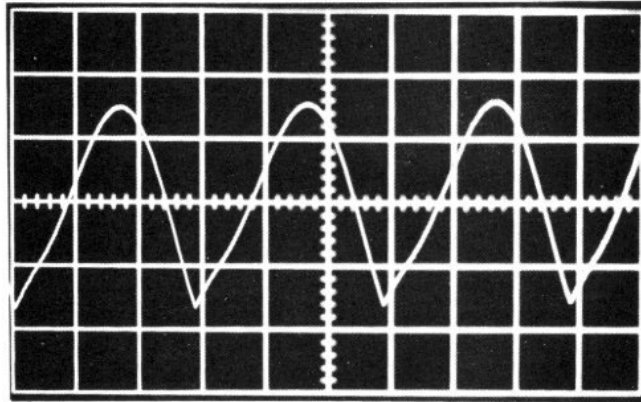

Q19 Collector = 6.5 V

0.05 Sec

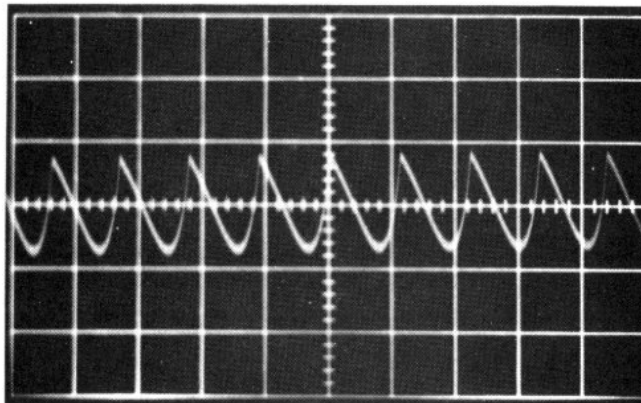

Q19 Base = 11 mv

Q19 Emitter = 0

- 6) **Electronic Tuning Fork Section** – The electronic tuning fork is a junction oscillator. A check of waveforms and timing is all that is necessary for A.C. measurements in order to determine if the circuit is oscillating.

Conditions: Switch – On (up) point of measurement = Q22 emitter (C51)

Coarse & Fine = Full cw

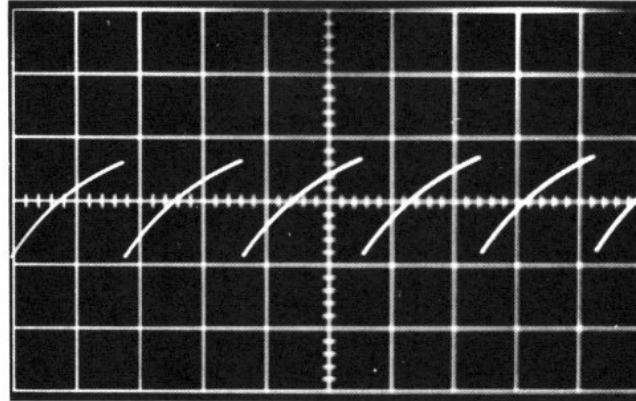

Coarse & Fine Full ccw

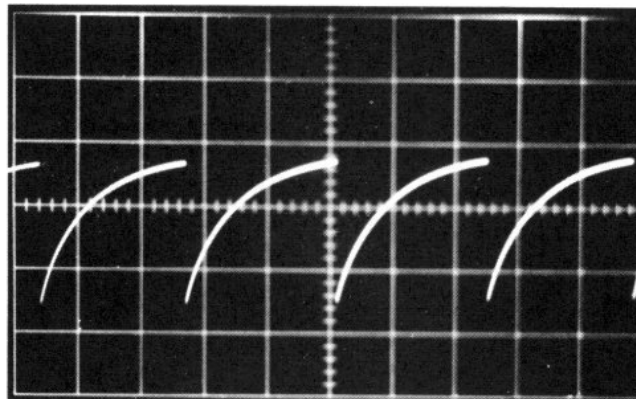

Remove signal from J1 and put scope probe on Q3B's emitter.

Volume = Full cw

Coarse & Fine = Full cw

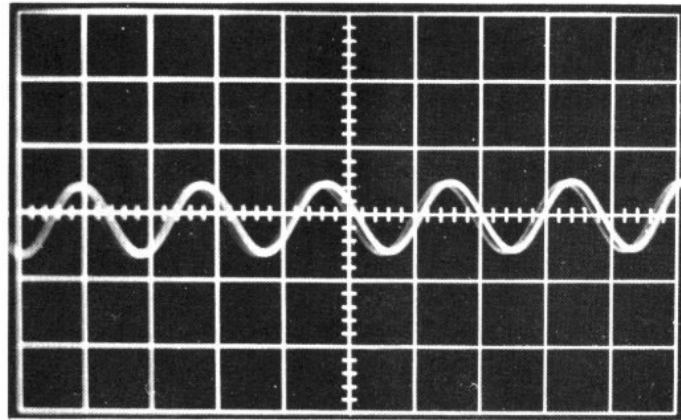

1-Volt Peak to Peak

Speed = cw intensity = ccw

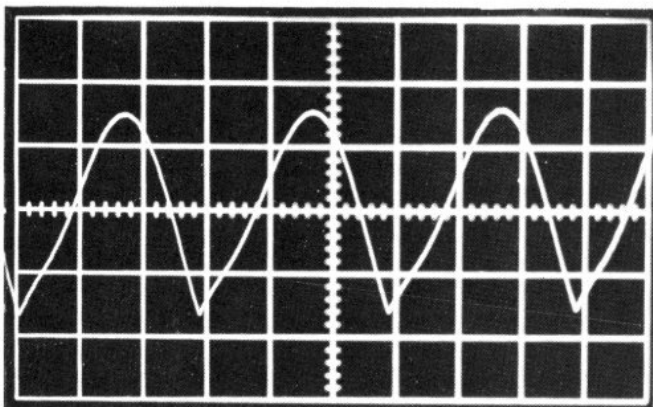

Q19

Collector

6V

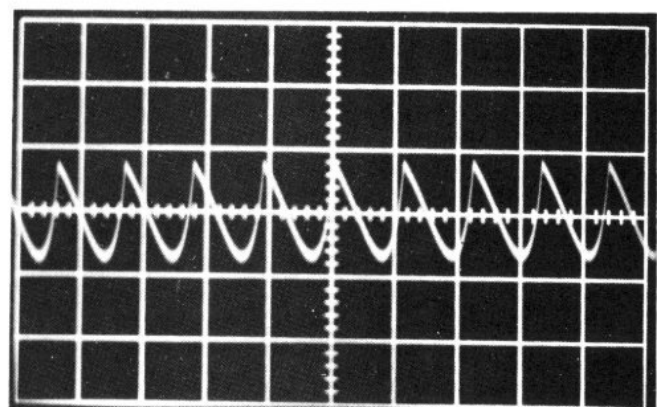

Q19

Base

15 mv

Q19 emitter = 0

Speed = cw Intensity = cw

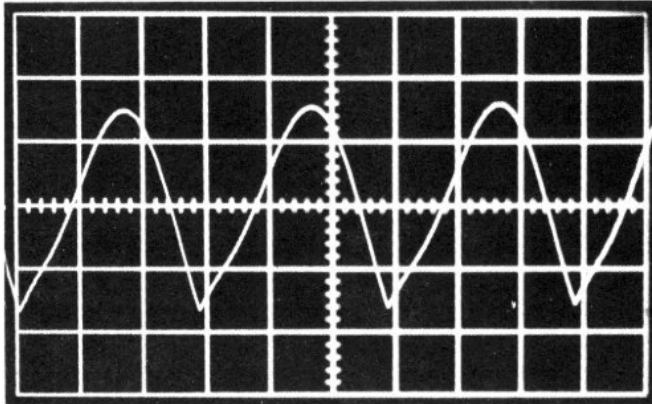

Q18 Base 3.2 V
 Q18 Emitter 3.2 V
 Q17 Base 3.2 V
 Q17 Emitter 3.2 V

Q18 Collector = 0
 Q17 Collector = 0

To this point, all circuit areas except the power amplifier and regulator have been tabulated as regards their A.C. signal levels. The power amplifier will be treated separately as will the regulator. Following, will be all the D.C. bias and voltage levels in table form for a correctly operating system. When trouble has been found during the signal tracing process, the next move is to measure the D.C. levels in the concerned area.

7) Preamp Section D.C. Voltages

Conditions: Line = 120 VAC; no signal; volume = ccw
 Treble = ccw; bass = ccw; range = 1; effect = mid.

Q	Collector	Base	Emitter
1A,B	+25V	+20.1V#	+19.5V
2A,B	+11V	+1.5V#	+0.9V
3A,B	+25V	+11V	+10.3V
4A,B	+7V	+4V#	+3.4V
5A,B	+12V	+7V#	+6.3V
Q6A,B	+25V	+12V	+11.3V

#Use VTVM or FET VM.

8) Reverb Section D.C. Voltages

Conditions: Same as in "7" above with the following additions
 Reverb = ccw

Q	Collector	Base	Emitter
11	+0.5V	+0.4V	+1.15V
12	+34V	+1.5V	+0.6V
13	+10V	+1.3V#	+0.7V
14	+7.3V	+4.3V#	+3.7V
15	+10.4V	+7.4V#	+6.8V
16	+15.5V	+10.4V	+9.8V

#Use FETVM or VTVM

9) Tremolo Section D.V. Voltages

Q	Collector	Base	Emitter
19	+3.4V (osc)	+0.6V#	0
18	0	+3.0V	+3.6V
17	0	+3.6V	+4.3V

(Q18 and Q17 reading depend on R67.)

10) Regulator Section (+25V) – The regulator does not amplify or generate any A.C. signals hence the following D.C. levels are all that is required to troubleshoot this part of the circuitry.

Q	Collector	Base	Emitter
30	+25.6V	+9.4V	+8.8V
31	+27.5V	+25.6V	+25V
38	0	0	+8.8V

If the Q38 emitter voltage is somewhat difference than that tabulated, this may be all right because a device used in this fashion as a zener reference will exhibit voltages anywhere from about 5 to 10 volts.

11) ETF Section D.C. Voltages

Q22 base₁ = +12V

- 12) Power Amplifier Section - A.C. and D.C. Voltages – The power amplifier is probably the most difficult area in which to locate a specific problem because it is a highly feedback system and a single problem can throw the entire voltage levels scheme out of balance. An attempt will be made to indicate some common symptoms and their probable causes along with the proper operating voltages, both A.C. and D.C. It would be wise to apply line power gradually by using a 5 amp variac setup. The power amplifier will be tested under two major modes – with load and without load. It would be very helpful if a 5 amp current meter were inserted in series with the +70V line. There are failures which can occur that do not allow full line voltage to be applied without blowing the fuse or burning up some component. This is because a fault exists which permits excessive current flow through the +70V line. The current meter will detect this condition immediately as the variac dial is increased slowly from zero. Typical variac hookup with current meter is shown below:

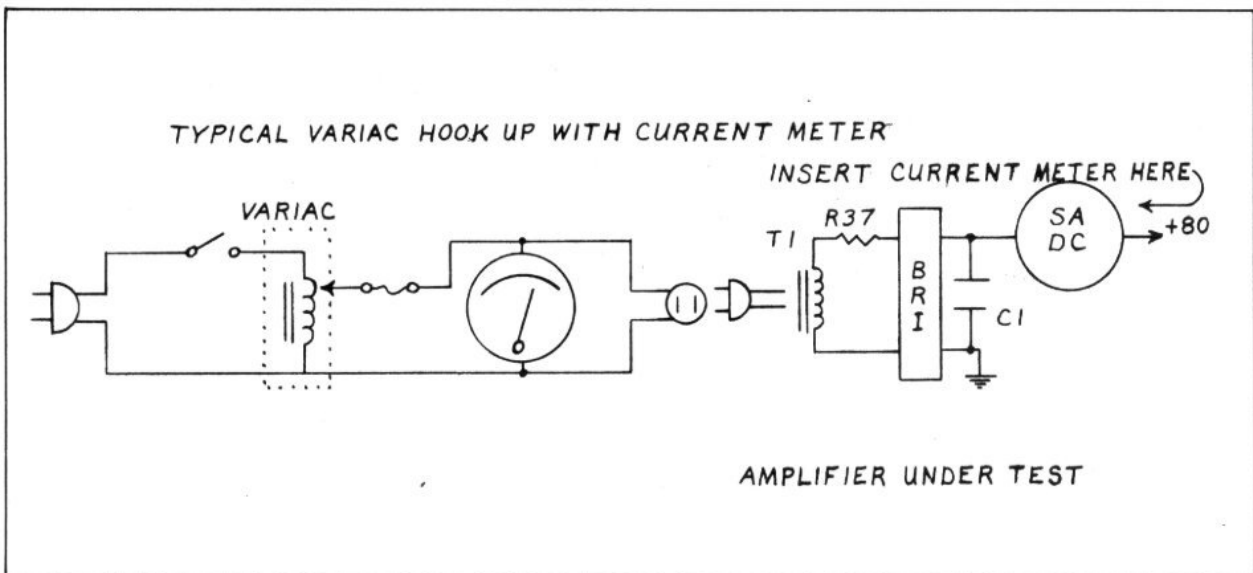

a) Large currents in the +70V line under no load can be caused by:

- (1) Any shorted transistor from Q32 thru Q37. More than one transistor can be shorted. To find shorted transistors use your VOM set on Rx1 scale. Remove primary power and apply meter leads to the emitter and collector terminals of each transistor successively. Any transistor giving a low or shorted indication should be *removed* from the circuit and checked in the conventional manner. Any transistor giving a doubtful reading should also be removed and carefully checked. Generally a truly shorted unit will indicate so regardless of the polarity of the meter leads.
- (2) R108 or D10 open.

- (3) Short to ground in the wiring harness containing the +70V line or on the P.C. board.
 - (4) Foreign material.
- b) Often the output line ((+) end of C64) will be at +70V when the amplifier is turned on. This can be caused by:
- (1) Q27 open.
 - (2) R18 open.
 - (3) Q26 open.
 - (4) R98 open to wiper.
 - (5) C59 shorted.
 - (6) R104 open.
 - (7) R96 open.
 - (8) R101 open.
- c) The output may be a ground. This can be caused by the following:
- (1) Q27 shorted.
 - (2) Q26 shorted.
 - (3) C56 shorted.
 - (4) R97 open.

The output line should be at around +35V. When this is so, Q26 and Q27 are operating correctly but this doesn't mean the remaining devices are all operating. Apply drive to the amplifier. The output should swing a good 70 V_{pp} at clipping with a good sine wave output under no load. Apply a 4Ω load to the amplifier after removing drive. Now re-apply drive slowly while watching the output voltage swing.

Following is a list of problems which can occur under loaded conditions and their probable causes.

- a) Negative half of signal OK but positive clips quite early.
- (1) Q32 open.
 - (2) Q34 and Q36 open.

- (3) C61 open.
 - (4) D5 or D6 shorted.
- b) Positive half of signal OK but negative clips quite early.
- (1) Q33 open.
 - (2) Q35 and Q37 open.
 - (3) D7, D8 or D9 shorted.

When the amplifier is operating under load it is important that all of the output transistors are operating. To test for this it is necessary to monitor the transistor currents while under loaded drive. Be certain that the oscilloscope ground is isolated from the power lines. Attach scope ground to output line (+ end of C64). Connect probe alternately to the emitters of Q34 and Q36. The waveforms observed should be as shown below:

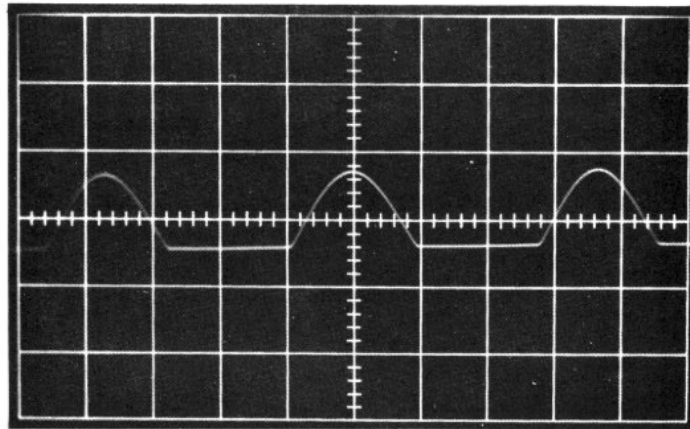

0.6 Volts

Now place scope ground at chassis ground and connect probe alternately to the emitters of Q35 and Q37. The resulting waveforms should be:

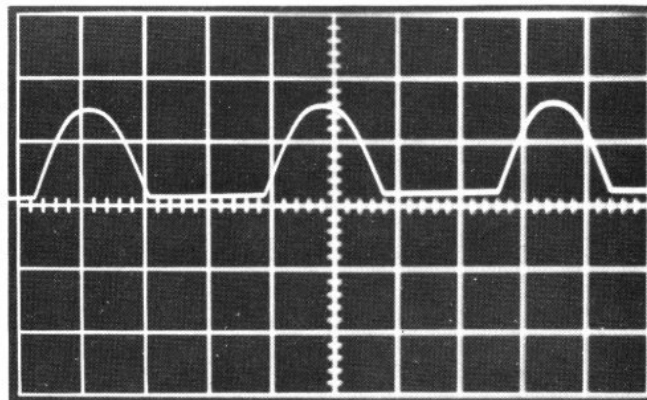

0.6 Volts

Note: Output should be just at the clipping level for the above waveforms.

The following table indicates the D.C. voltages throughout the power amplifier under normal conditions.

No load and no signal; line = 120 VAC

Q	Collector	Base	Emitter
23	+18V	+6.8#	+6.2V
24	+15V	+20.4V#	+9.8V
26	+3.2V	+31.4V	+32V
27	+35V	+0.72V	+0.15V
33	+0.43V	+35V	+36V
35/37	+35.8V	+0.43V	0
32	+70V	+37V	+36.2V
34/36	+70V	+36.2V	+36V

JUNCTION OF R97 and R98 = +33V

JUNCTION OF R105 and R107 = +60V

The following table indicates the A.C. signal levels under no load conditions

AGC = off; freq = 1000 Hz.

Q	Collector	Base	Emitter
23	0.85 Vpp	225 mv	220 mv
24	0.8 Vpp	0.85V	0.85V
26	0.8V	0.8V	0.8V
27	50V	8 mv	6 mv
32	0	50V	50V
33	0.5V	50V	50V
34/36	0	50V	50V
35/37	50V	0.5V	6 mv

Waveforms on next page.

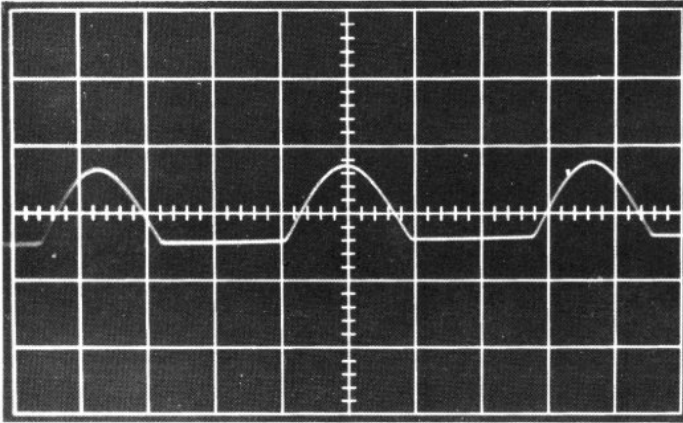

Q33 Collector
 Q35 Base
 Q37 Base

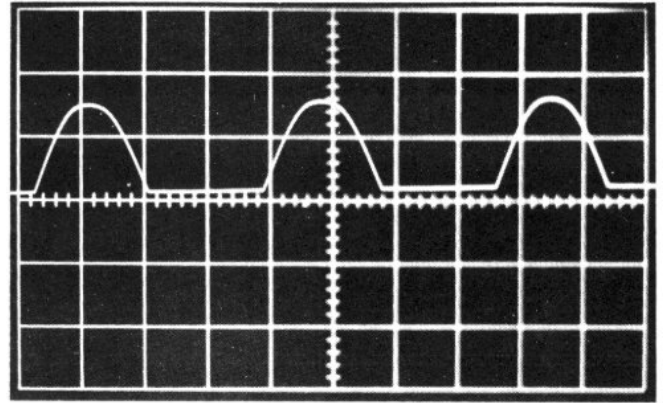

Q35 Emitter
 Q37 Emitter

The following tables indicate signal levels under load:

Conditions: Input — such as needed to produce 35 V_{pp} across 4Ω load.

Q	Collector	Base	Emitter
32	0	39V	37.5
33	1.35V	39V	37V
34/36	0	37.5V	37V
35/37	37V	1.35V	0.6V

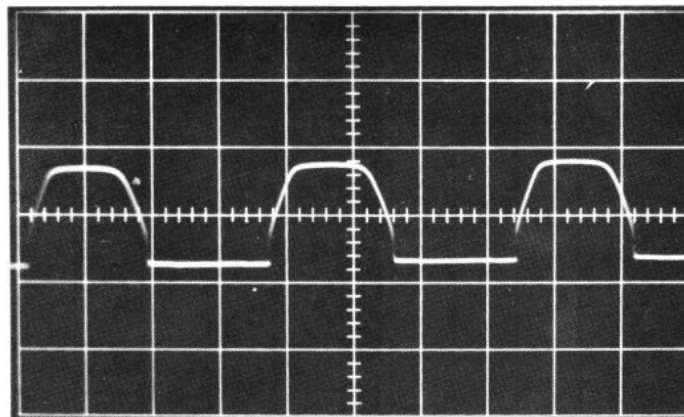

Q33 Collector
 Q35/37 Base & Emitter

Power Output – Increase drive until clipping just occurs across 4Ω load.

$$\text{Line} = 120 \text{ VAC}; E_o = 45 \text{ Vpp} = 62\text{W rms.}$$

Be certain that clipping is symmetric. Power bandwidth at the 50W level.

50 Hz – 15 KHz

AGC – Remove load from amplifier and drive output to 70 Vpp (just at clipping) with the AGC switch off. Now turn on the AGC and the output should drop to 50 Vpp.

D. Adjustments

- 1) Bias adjustment in the tremolo circuit R67.

Conditions: Intensity = full ccw
Reverb = full ccw
Volume = full cw
Freq. = 1000 Hz.

Apply signal to J1 and increase level until 500 mvpp is established at the emitter of Q3A. Now place scope probe on the base of Q4A. Adjust R67 for a level of 500 mv at the base of Q4A.

- 2) Power Amplifier Adjustments – R208 sets the bias current in the output transistors. Apply a 4Ω load and signal enough to produce 1 Vpp across the load. Frequency = 400 Hz. Line voltage = 110 VAC. Beginning with R108 anticlockwise, turn cw until crossover distortion just disappears. Crossover distortion appears as shown below:

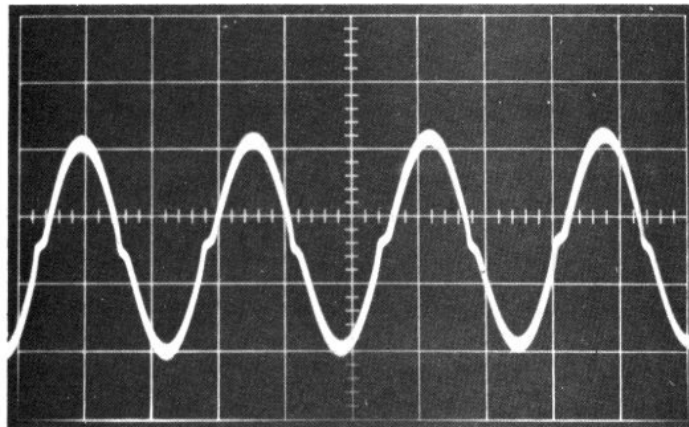

The adjustment of R98 is made under 4Ω load and full output. Adjust R98 so that the positive and negative signal peaks clip at the same time.

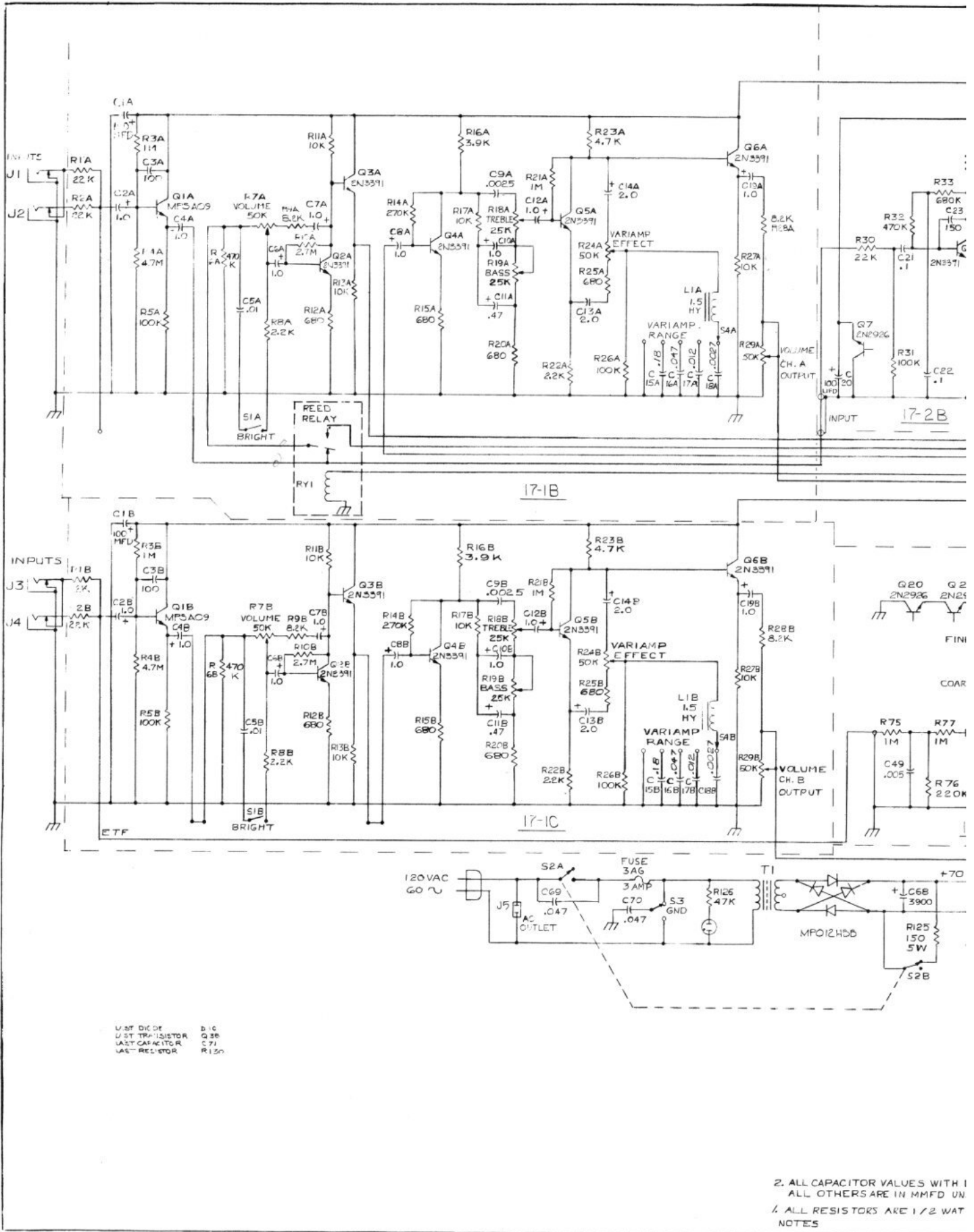

U 5% DIODE
 U 5% TRANSISTOR
 C LAST CAPACITOR
 R LAST RESISTOR

D 10
 Q 30
 C 71
 R 150

2. ALL CAPACITOR VALUES WITH 1
 ALL OTHERS ARE IN MMFD UN
 3. ALL RESISTORS ARE 1/2 WAT
 NOTES

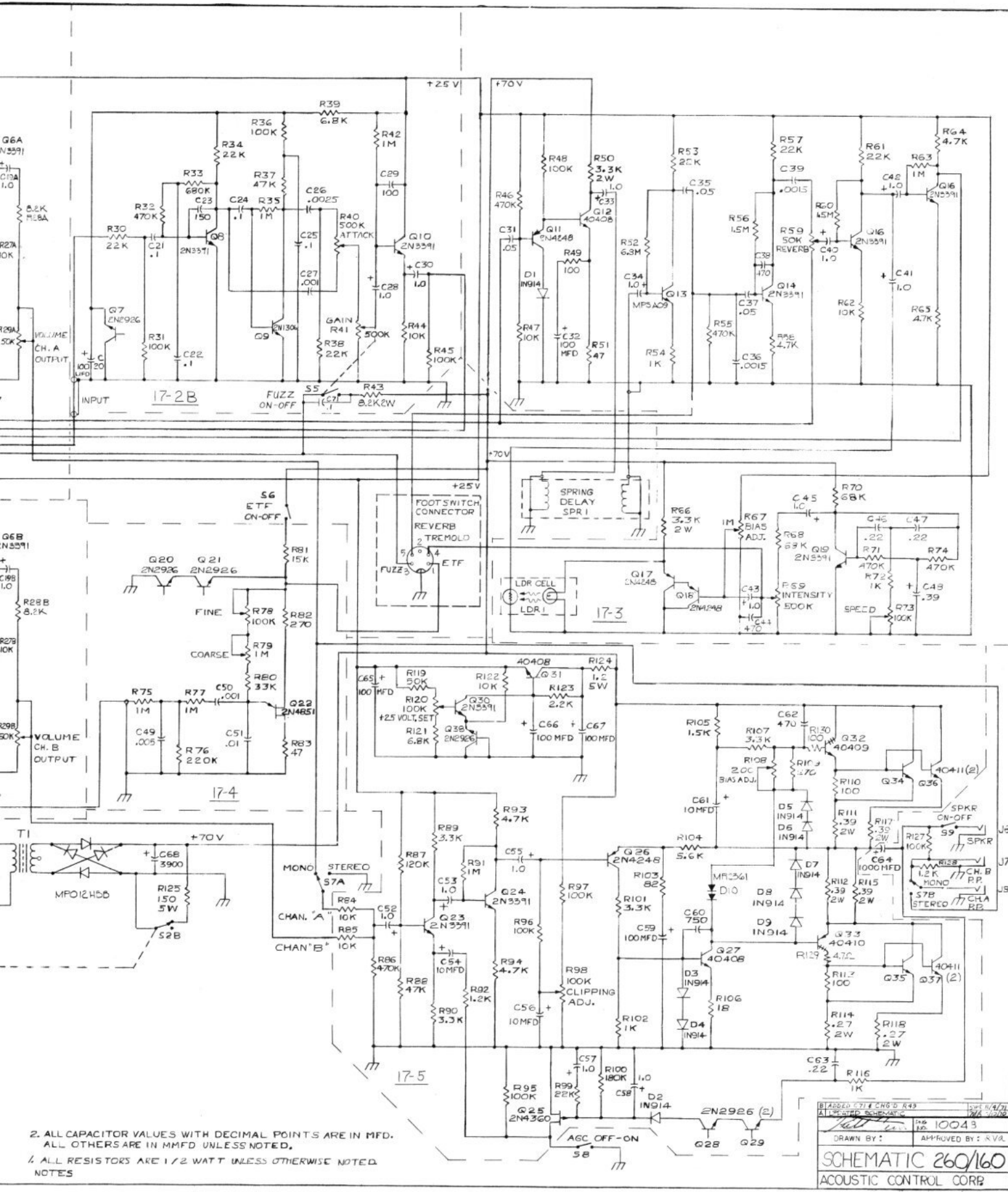

2. ALL CAPACITOR VALUES WITH DECIMAL POINTS ARE IN MFD.
 ALL OTHERS ARE IN MMFD UNLESS NOTED.

4. ALL RESISTORS ARE 1/2 WATT UNLESS OTHERWISE NOTED.

NOTES

BLASBUD C71 C85 D R49		DATE 9/4/71
ALL PARTS LISTED		7/16 10/28
DRAWN BY: [Signature]		REV 10043
APPROVED BY: N.V.L.		
SCHEMATIC 260/160		
ACOUSTIC CONTROL CORP		

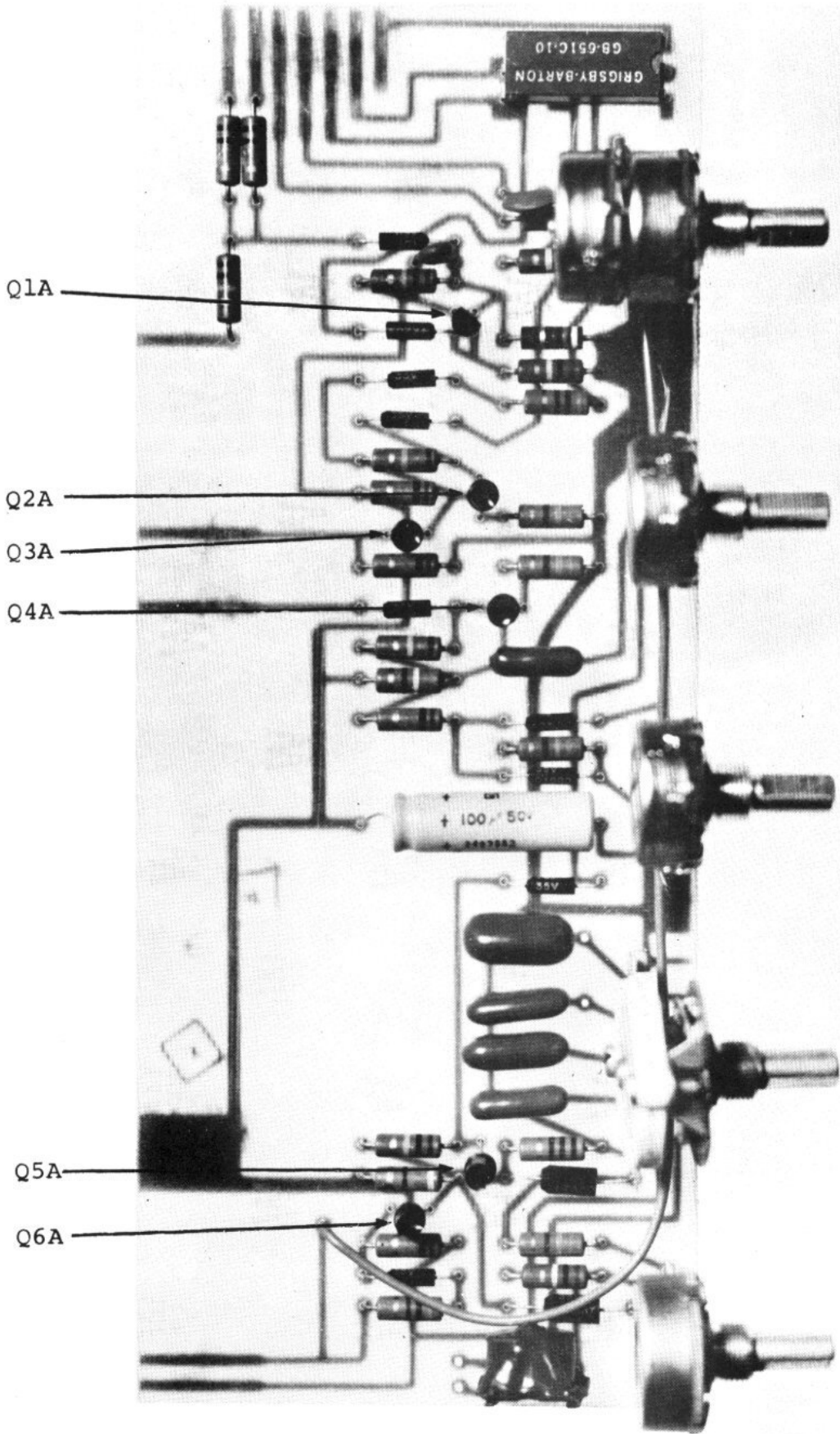

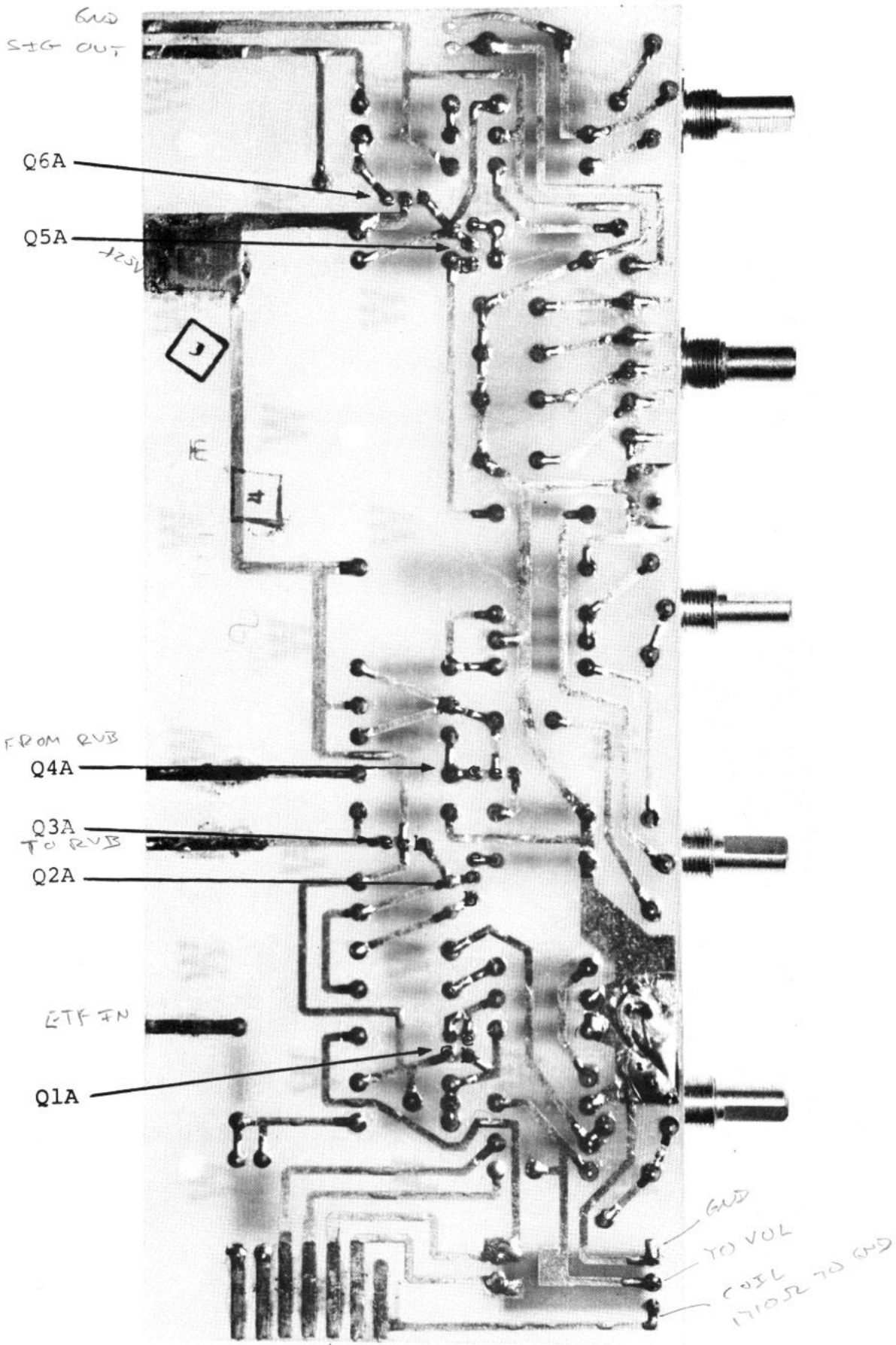

2
 H
 H
 BRT
 BRT
 JOF
 FROM FUS

17-1B WITH THE TRIRIDGE RELAY

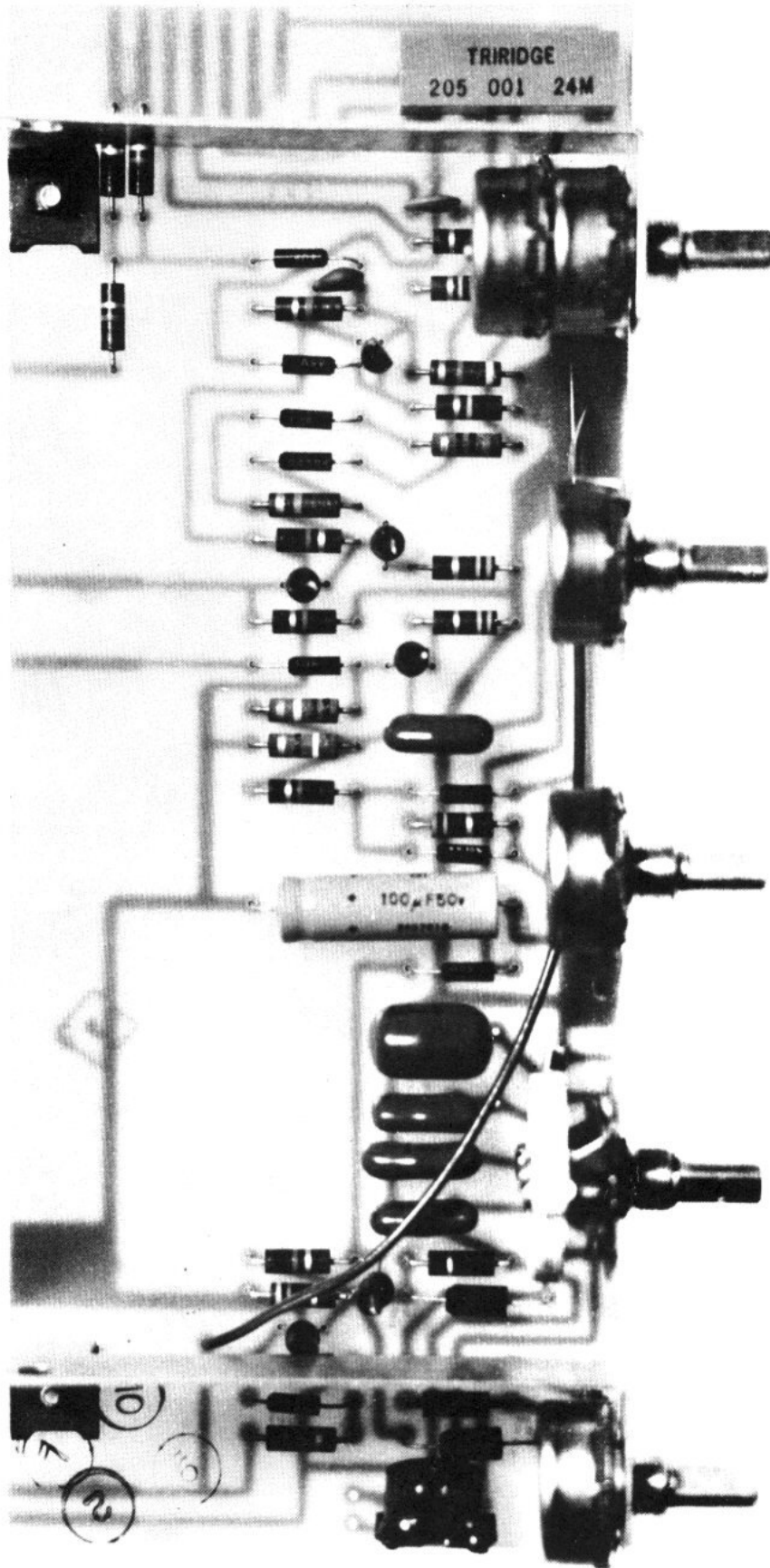

FOR TRANSISTOR LOCATION SEE 17-1B

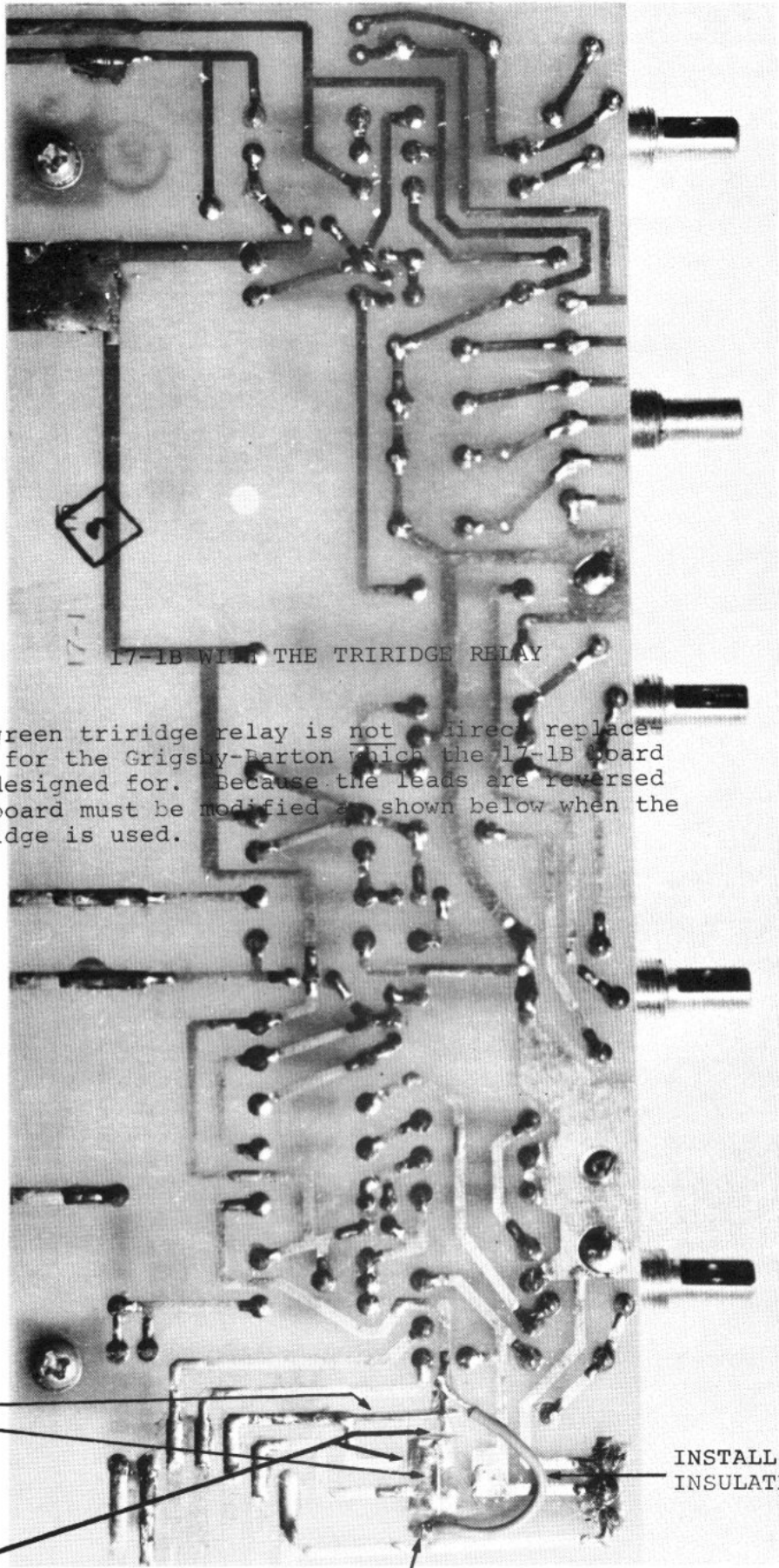

17-1B WITH THE TRIRIDGE RELAY

The green triridge relay is not a direct replacement for the Grigsby-Barton which the 17-1B board was designed for. Because the leads are reversed the board must be modified as shown below when the triridge is used.

INSTALL JUMPER

CUT THE CIRCUIT

DRILL SMALL HOLE

INSTALL INSULATED WIRE



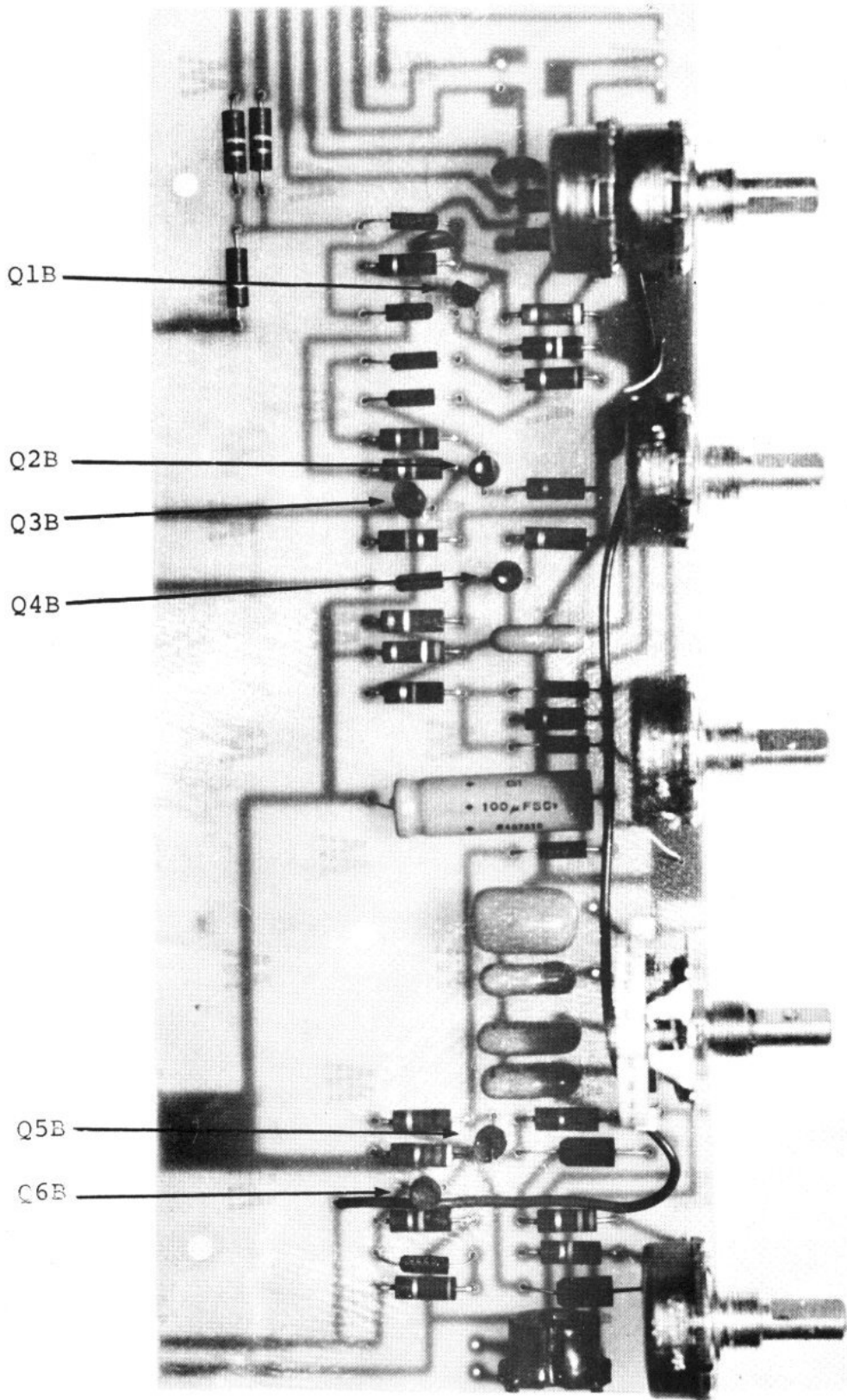

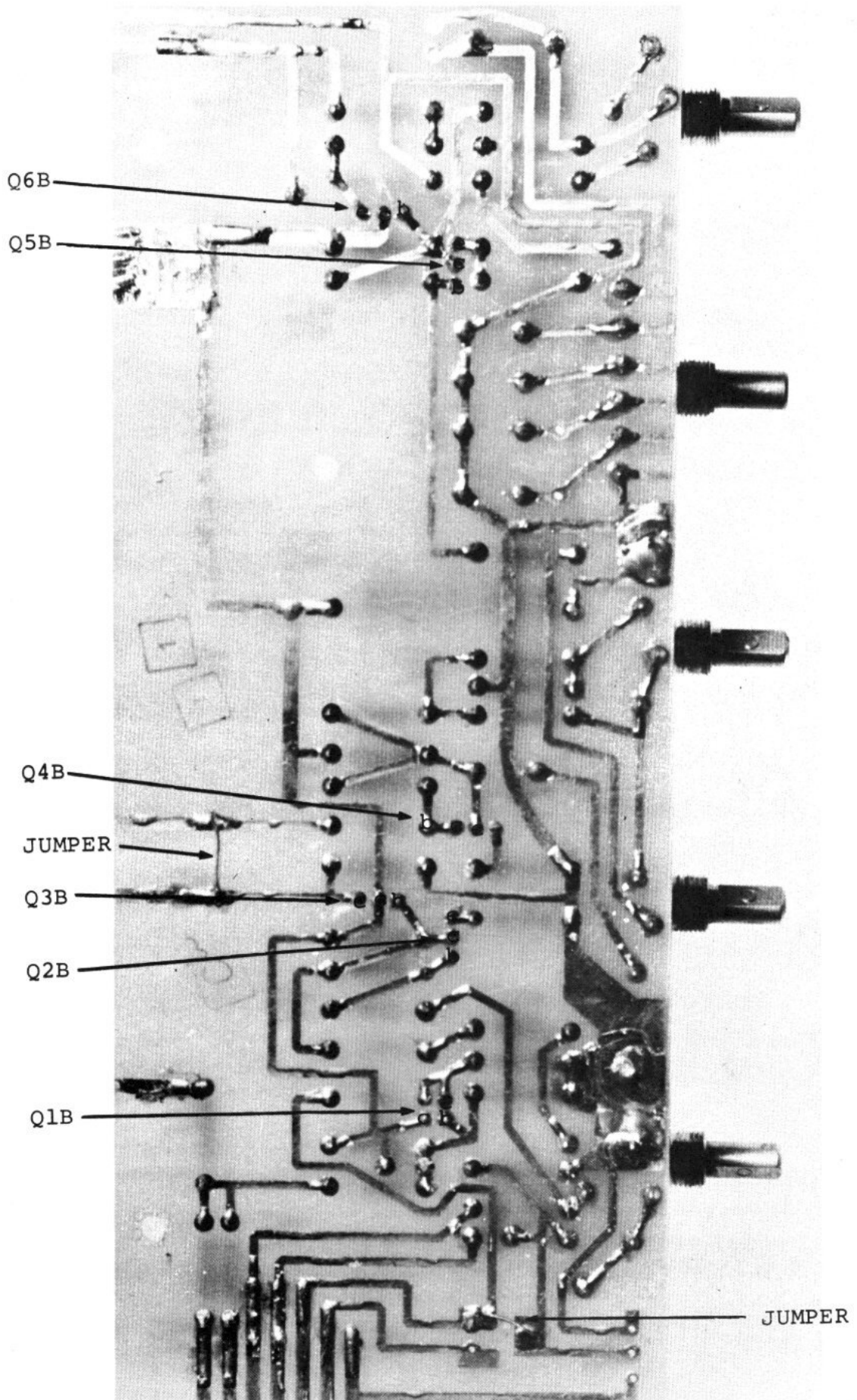

Q6B

Q5B

Q4B

JUMPER

Q3B

Q2B

Q1B

JUMPER

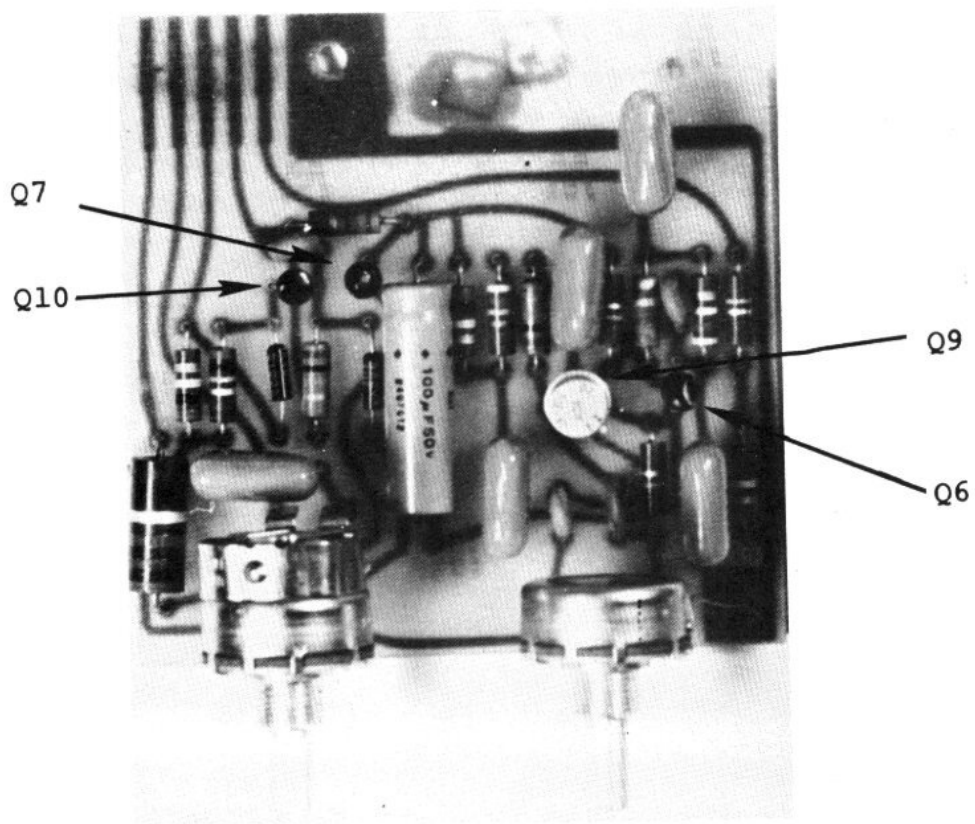
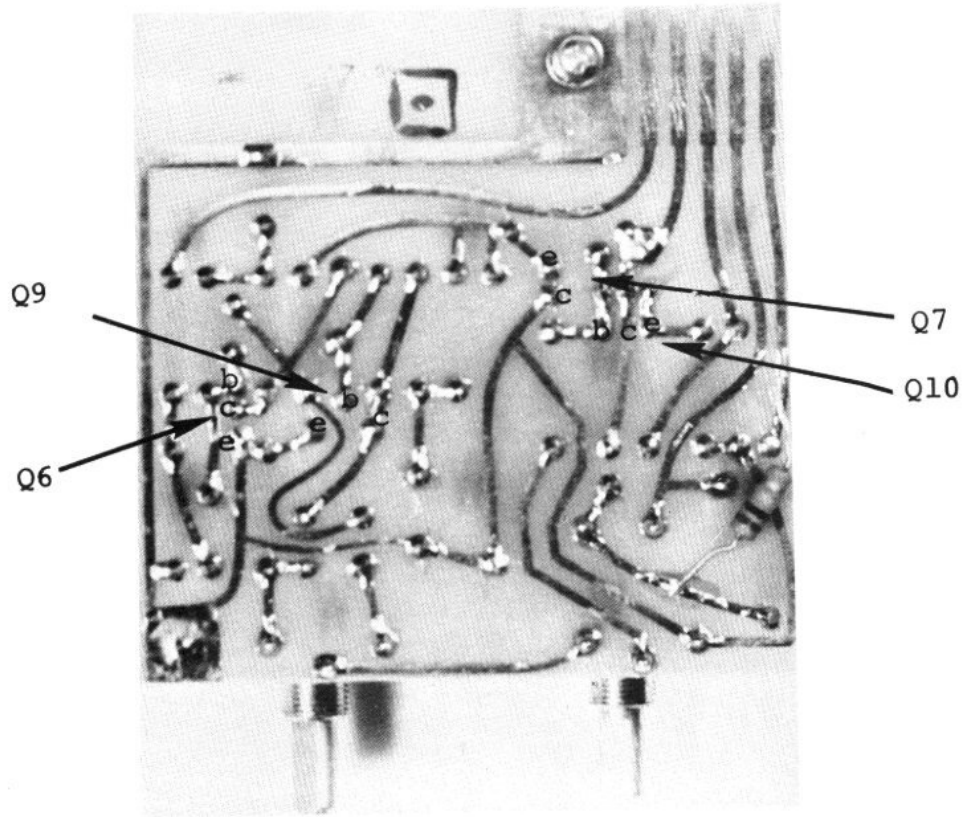

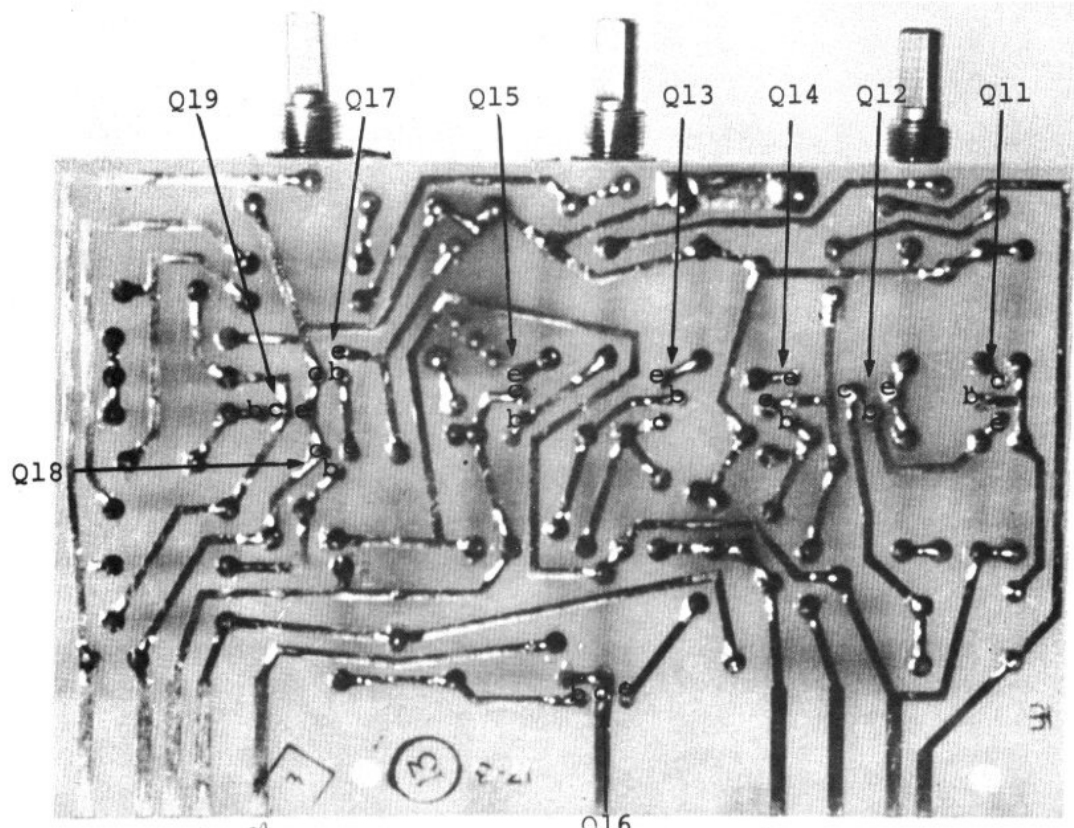
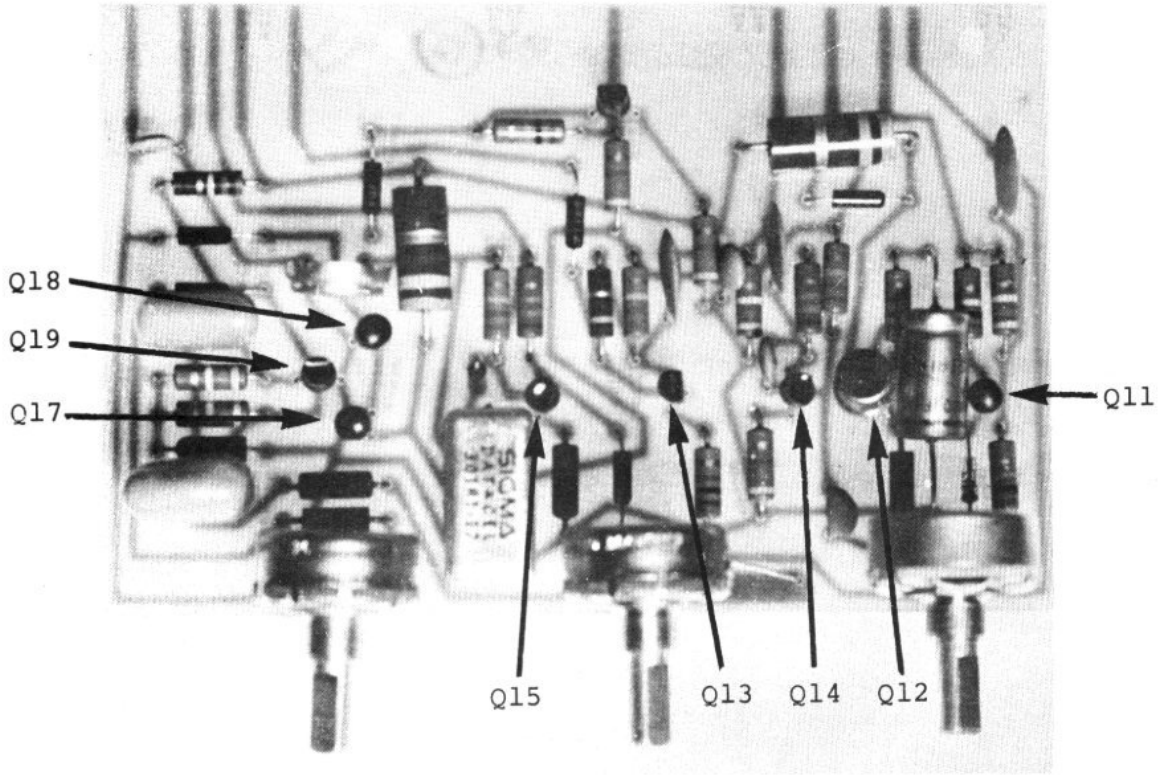

FROM FT SW
GND
W16%
+70V
FROM RVB
25
SIG OUT
RVB FT SW
TO RVB
+25V
SIG IN

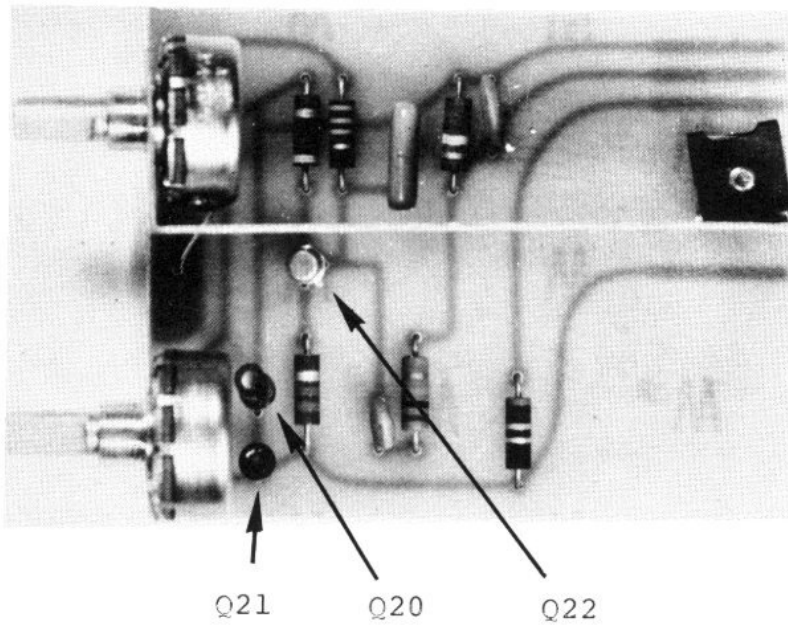
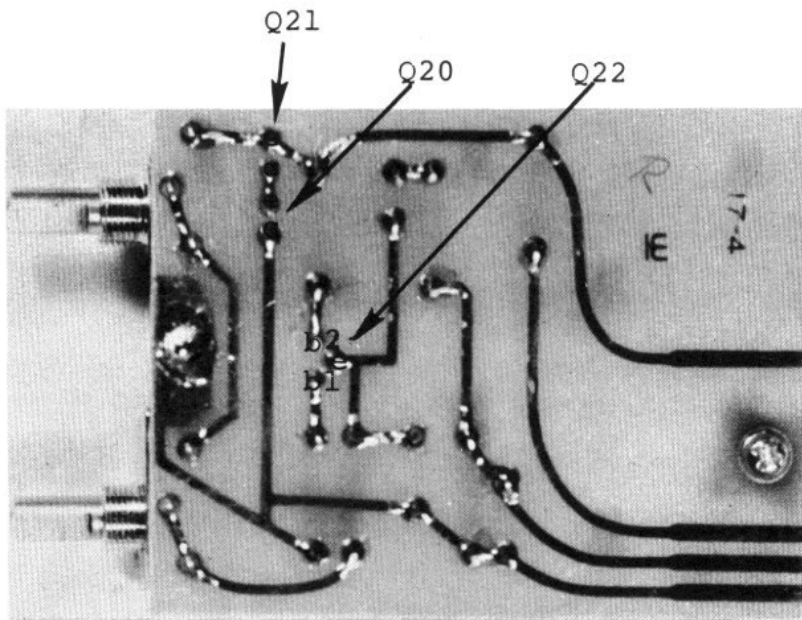

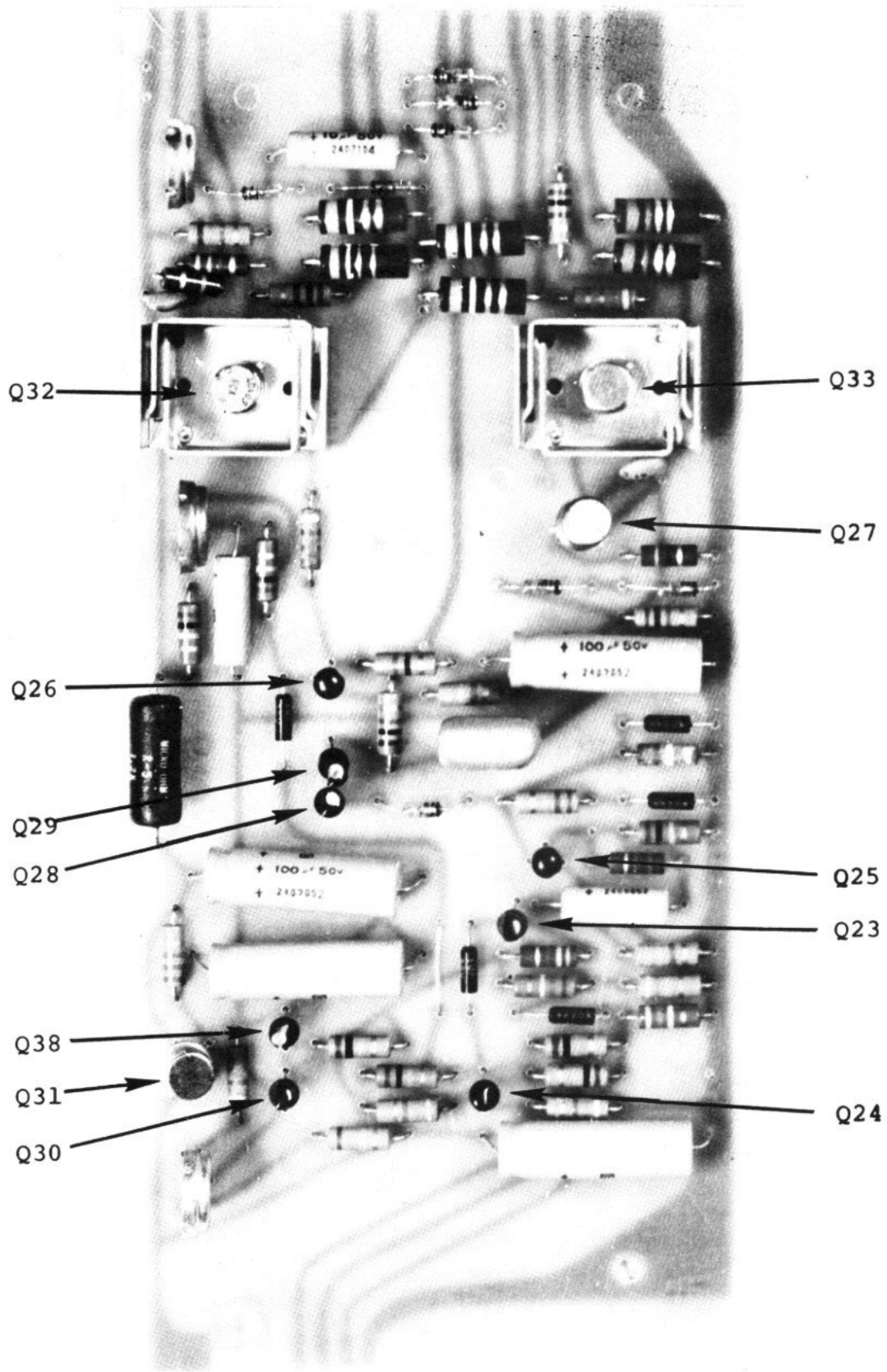

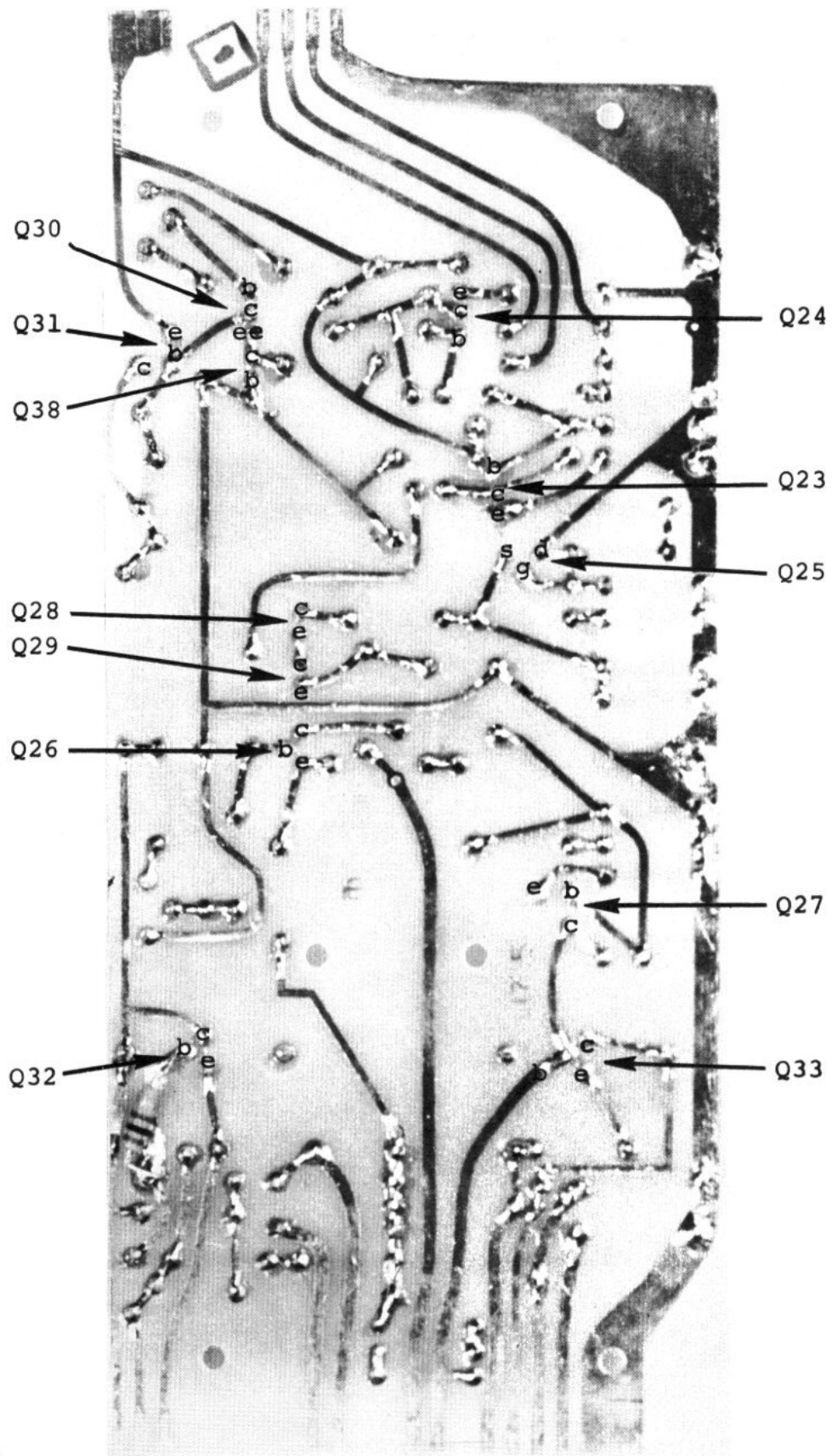

17-5
B

MODEL 260

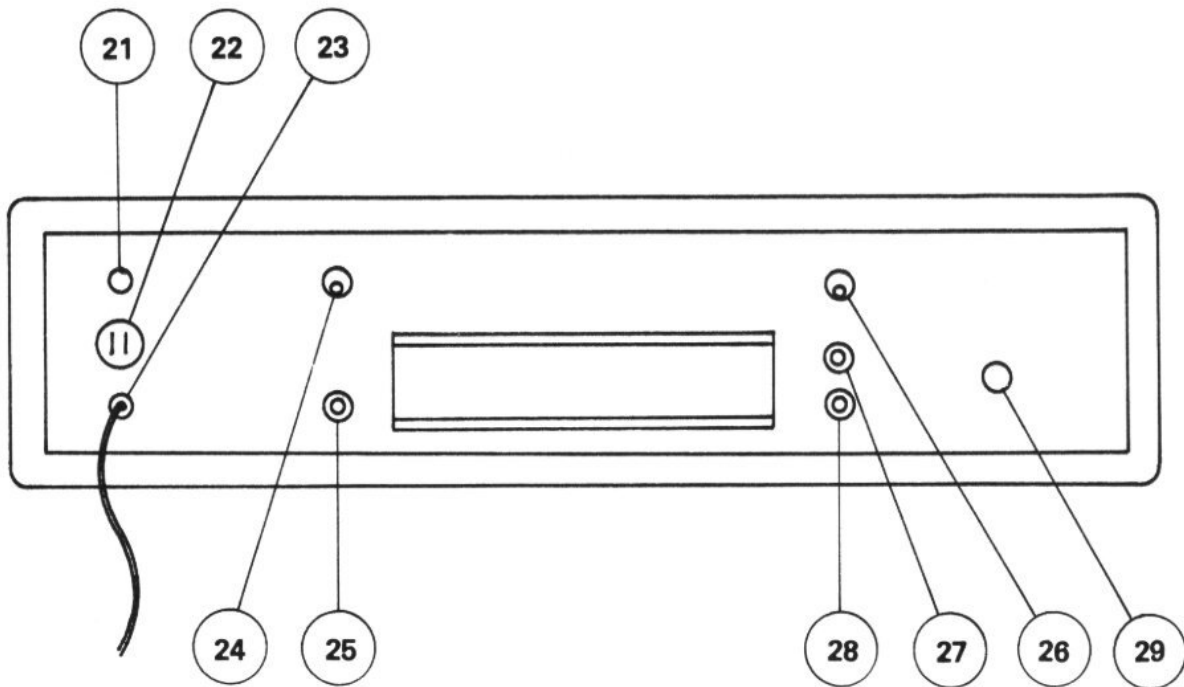
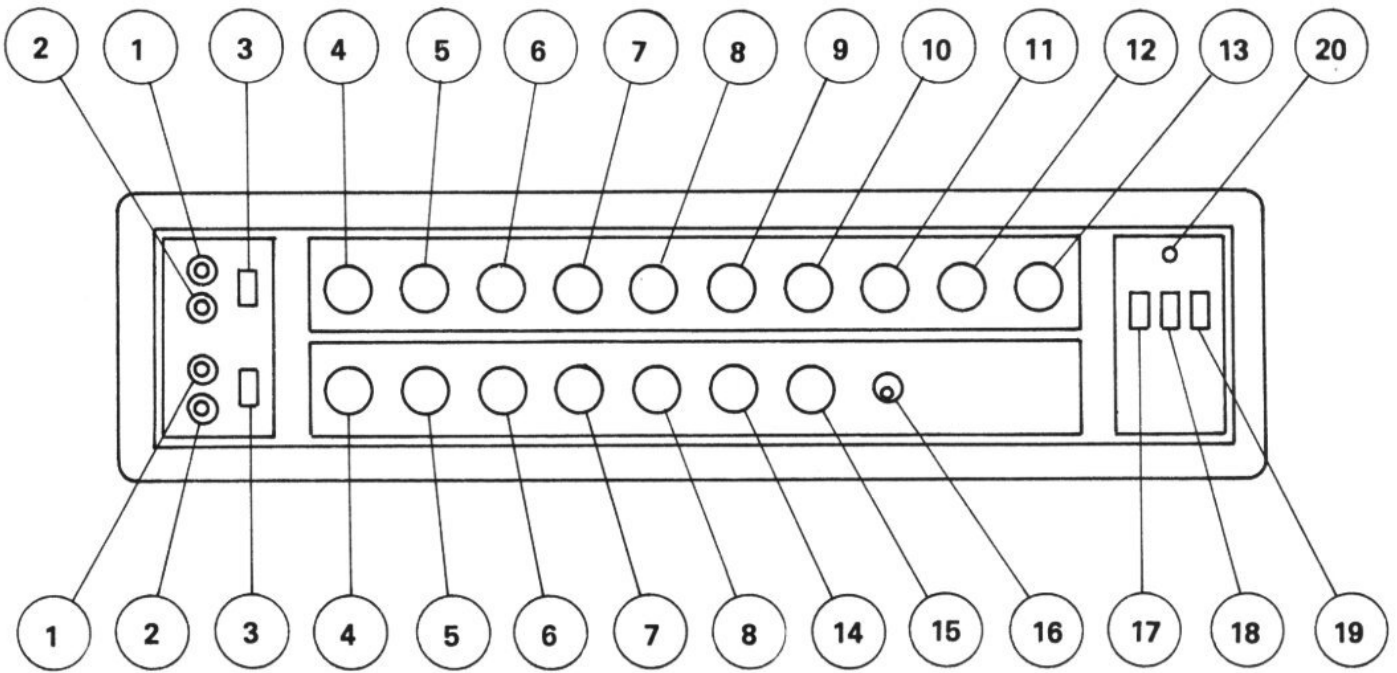

CONTROL LOCATIONS

1. High Gain Input Jack
2. Low Gain Input Jack
3. Bright Switch
4. Volume
5. Treble
6. Base
7. Variamp
8. Effect
9. Fuzz Attack
10. Fuzz Gain
11. Reverb
12. Tremolo
13. Tremolo Intensity
14. Electronic Tuning Fork
15. E.T.F. Fine Tuning
16. On/Off Switch for E.T.F.
17. Automatic Gain Control Switch
18. Ground Reverse Switch
19. Power Switch
20. Pilot Light
21. Fuse
22. AC Receptable
23. Power Line
24. Speaker Switch
25. Speaker Jack
26. Stereo Jack
27. Channel "A" Output Jack
28. Channel "B" Output Jack
29. Footswitch Plug

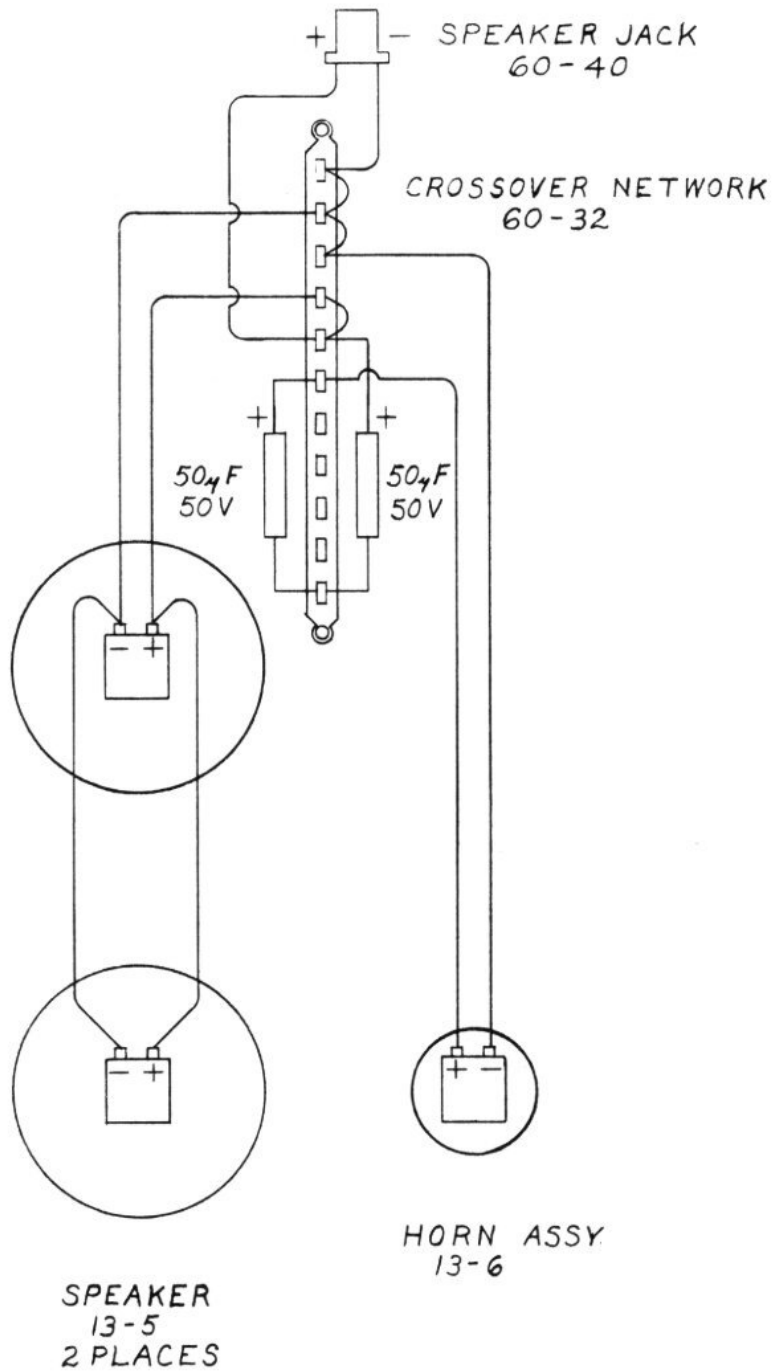

SCALE: NONE	APPROVED BY: <i>Duke Johnson</i>	DRAWN BY: DMC
DATE: 9/22/71	22 Sept 71	REVISED
MODEL 261 SPEAKER WIRING		
ACOUSTIC CONTROL CORP		DRAWING NUMBER 1227

8 1/2 X 11 PRINTED ON NO. 1000H CLEARPRINT

ACOUSTIC CONTROL CORPORATION

Troubleshooting Chart

MODEL 260

Problem	Cause	Suggested Check
Amplifier blows fuses	Short circuit	Open line. Check all transistors. Wrong size fuse. Check network connections, Bridge-transformer check bias voltage. Shorted diode in the limiter circuit D5, D6, D7, D8, D9. Check bias voltage. Shorted power transistor.
Lack of power or bass	Wiring of speaker	Speaker possibly wired out of phase. Note: Cone back pressure will move the cone of the unit not working. One speaker inoperative. Check network connections.
Intermittant operation	Loose wire or bad soldered joint	Check control potentiometer connection. Check audio cables.
Buzzing sound on all frequencies	Possible loose connection	Control potentiometers may have worked loose from the PC board. Check for possible open ground.
No signal in top channel except when fuzz gain is turned on	Control element not operating	Check the capacitor connected across the fuzz switch terminals on 17-2 PC board or 102.
No output channel #1	Improper settings	Check mono-sterio switch. Reverb volume control may be turned way down, (but not off).

PARTS LIST FOR A MODEL 260

<u>Acoustic Part Number</u>	<u>Part</u>
14-2	Side Plate
14-3	Front Chassis
14-4	PC Bracket
14-5	Amp-Wood
14-6	Strap Handle
14-7	Foot
14-13	3/4" Cup
14-19	Footswitch Cov. Plt.
14-20	Rubber Foot
14-21	Rear Chassis
14-22	Transistor Shield
14-23	3/4" Handle Retanr.
15-1	100 pf Disc.
15-2	150 pf Disc.
15-3	0.001 mf Disc.
15-4	0.0025 mf Disc.
15-5	0.0027 mf Dip.
15-6	0.005 mf Disc.
15-7	0.01 mf Dip.
15-8	0.01 mf Dip.
15-10	0.047 mf Tubular
15-11	0.1 mf Dip.
15-12	0.47 mf 35v Tant.
15-13	1.0 mf 35v Tant.
15-14	2.2 mf 35v Tant.
15-16	100 mf 40v Elect.
15-17	1000 mf 40v Elect.
15-18	470 pf Disc.
15-19	750 pf Disc.
15-20	10 mf 50v Elect.
15-21	3900 mf 80v Elect.
15-23	0.0015 mf Disc.
15-25	0.012 mf Dip.
15-26	0.047 mf Dip.
15-27	0.05 mf Disc.
15-28	0.18 mf Dip.
15-29	0.22 mf Dip.
15-30	0.39 mf 35v Tant.
17-1	P.C. Board
17-2	P.C. Board
17-3	P.C. Board

<u>Acoustic Part Number</u>	<u>Part</u>
17-4	P.C. Board
17-5	P.C. Board
18-2	1.5 HY Torroid
21-1	Terminal 2 pt
21-2	Phone Jack – Open
21-3	Phone Jack – Closed
21-4	Jack – 5 pin
21-5	AC Outlet
21-7	Phono Plug
21-11	Socket
21-13	#10 Crimp Lug
21-14	Plug – 5 pin
24-2	Knob
24-3	Faceplate
28-1	Clamp 1-3/8
28-4	Clamp – 2"
28-6	PC Brkt – MB128
28-37	Fibre Gasket
28-44	3 Prong Corners
28-45	3/4 x #6 Oval Hd Drive Screw
28-46	2 Prong Corners
28-47	Glides, Steel Nickel
28-48	Glides, Steel Nickel
31.5-4	Footswitch Casting 4 Hole
31.5-5	Chassis Scrned.
31.5-6	Spring Revb. 4c
37-1	Data Cell
39-1	Pilot Light
45-1	Relay
47-1	4.7 10% 1/2w C.C.
47-1	18 10% 1/2w C.C.
47-1	47 10% 1/2w C.C.
47-1	82 10% 1/2w C.C.
47-1	100 10% 1/2w C.C.
47-1	270 10% 1/2w C.C.
47-1	680 10% 1/2w C.C.
47-1	1k 10% 1/2w C.C.
47-1	1.2k 10% 1/2w C.C.
47-1	1.5k 10% 1/2w C.C.
47-1	2.2k 10% 1/2w C.C.
47-1	3.3k 10% 1/2w C.C.
47-1	3.9k 10% 1/2w C.C.
47-1	4.7k 10% 1/2w C.C.

<u>Acoustic Part Number</u>	<u>Part</u>
47-1	5.6k 10% 1/2w C.C.
47-1	6.8k 10% 1/2w C.C.
47-1	8.2k 10% 1/2w C.C.
47-1	10k 10% 1/2w C.C.
47-1	15k 10% 1/2w C.C.
47-1	22k 10% 1/2w C.C.
47-1	33k 10% 1/2w C.C.
47-1	47k 10% 1/2w C.C.
47-1	68k 10% 1/2w C.C.
47-1	100k 10% 1/2w C.C.
47-1	120k 10% 1/2w C.C.
47-1	180k 10% 1/2w C.C.
47-1	220k 10% 1/2w C.C.
47-1	470k 10% 1/2w C.C.
47-1	680k 10% 1/2w C.C.
47-1	1m 10% 1/2w C.C.
47-1	1.5m 10% 1/2w C.C.
47-1	2.7m 10% 1/2w C.C.
47-1	4.7m 10% 1/2w C.C.
47-1	6.8m 10% 1/2w C.C.
47-1	270k 10% 1/2w C.C.
47-1	1.2k 10% 1/2w C.C.
47-1	47k 10% 1/2w C.C.
47-1	100k 10% 1/2w C.C.
47-1	220k 10% 1/2w C.C.
47-2	3.3k 10% 2w C.C.
47-2	8.2k 10% 2w C.C.
47-3	150 10% 5w W.W.
47-3	1.2k 10% 5w W.W.
47-5	0.27 10% 2w W.W.
47-5	0.39 10% 2w W.W.
47.5-8	10k Trim.
47.5-9	100k Trim.
47.5-10	200 Trim.
47.5-18	1m Trim.
47.5-19	50k
47.5-20	100K
47.5-21	500k
47.5-22	1m
47.5-23	25k
47.5-24	50k Dual
47.5-25	500k w/Switch
48-1	2N1306

<u>Acoustic Part Number</u>	<u>Part</u>
48-1	2N2926
48-1	2N3391
48-1	2N4248
48-1	2N4360
48-1	2N4851
48-3	40408 RCA
48-5	IN914
48-6	40409 RCA
48-7	40410 RCA
48-9	MG2361 MOTO.
48-13	MPS A09 MOTO.
48-15	60085
48-19	MPO 12 JBD
51-1	3 A Rocker Switch
51-2	Toggle Switch
51-3	Fuse Holder
51-7	Rotary Switch
51-8	Push-Push Switch
51-9	3A 3AG Fuse

SPECIFICATIONS

260 Top

Preamplifier Gain	x40 (high gain input)
Signal-to-noise Ratio	80db
Minimum Input Voltage for Rated Output	31mv
Maximum Input Voltage	5.2 Volts
Power Output Measured Across 3.2 Ohm Load	125 Watts (RMS)
Channels	2
Inputs Per Channel	2 (1/4" phone jacks)
Gain Difference Between Inputs	6db
Maximum Output Voltage of Channel A and Channel B	
Power Plus Output Jacks	230mv
110 Volt AC Outlet	1
Footswitch Jack (Fuzz, Reverb, Tremolo, ETF)	1 Multipin Connector
Fuse	3 Amp (3A 3AG)
Controls Channel A	
Bright/Normal Switch	Rocker Type
Volume	Rotary Potentiometer
Treble	Rotary Potentiometer
Bass	Rotary Potentiometer
Variamp Range Control	Rotary 5 Position Switch
Variamp Effect Control	Rotary Potentiometer
Fuzz Attack Control	Rotary Potentiometer
Fuzz Gain Control	Rotary Potentiometer w/Switch
Reverb	Rotary Potentiometer
Tremolo Speed Control	Rotary Potentiometer
Tremolo Intensity Control	Rotary Potentiometer
Controls Channel B	
Bright/Normal Switch	Rocker Type
Volume	Rotary Potentiometer
Treble	Rotary Potentiometer
Bass	Rotary Potentiometer
Variamp Range Control	Rotary 5 Position Switch
Variamp Effect Control	Rotary Potentiometer
Electronic Tuning Fork Fine Control	Rotary Potentiometer
Electronic Tuning Fork Coarse Control	Rotary Potentiometer
Electronic Tuning Fork Off/On Switch	Lever Type
Power Section Controls	
Automatic Gain Control (AGC)	Rocker Type
Ground Reverse (GND)	Rocker Type
Power On/Off (PWR)	Rocker Type
Indicator	1 Neon Lamp
Rear Panel Controls	
Stereo/Mono Switch	Lever Switch
Speaker On/Off Switch	Lever Switch

Channel A Power Plus Output Jack	1/4" phone jack
Channel B Power Plus Output Jack	1/4" phone jack
Speaker Output Jack	1/4" phone jack
Size	6" H x 24" W x 12" D
Shipping Weight	30 lbs.
261 Speaker Bottom	
Speaker Complement	2 Altec Lansing 15" Speakers
Horn Driver	1 Folded Eponential
Horn Length (Unfolded)	20.5 inches
Horn Mouth Area	80 sq. in.
Horn Cutoff Frequency	800 Hz (Determined by series Network condenser)
Cabinet Design	Sealed Compression System
Cabinet Construction	3/4" Plywood Triple Braced
Horn Access	Removable Rear Panel
Speaker Access	Snap-Off Grill Assembly
Speaker Mounting	4 Quick-clamps (per speaker)
Horn Mounting	Sliding Nylon Block in Aluminum Track
Size	48" H x 24" W x 12" D
Shipping Weight	130 lbs.

418B Musical Instrument Loudspeaker

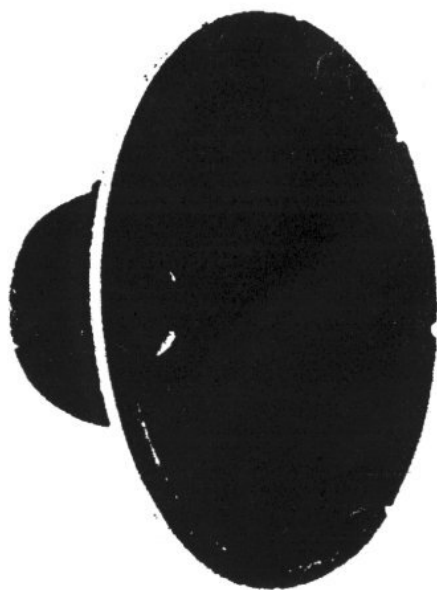

The ALTEC 418B Musical Instrument Loudspeaker is a rugged 15" loudspeaker designed for use in musical entertainment systems of moderate size and coverage area where true high-fidelity reproduction must be combined with high power output.

The 418B has a heavy permanent magnet, a structurally reinforced die-cast aluminum frame, a 3"-diameter voice coil of edge-wound aluminum ribbon, and exceptionally compliant cone suspension. It is sealed against dust and dirt.

The smooth response and excellent linearity of the 418B loudspeaker is achieved by strict adherence to precision design and manufacturing tolerances. Axial retention of the voice coil in a magnetic field, uniform over the full excursion, ensures clarity of music reproduction at high power levels. Low cone resonance, when coupled to a suitable enclosure, virtually eliminates all doubling or self-generation of unwanted harmonic components.

The 418B has a continuous power rating of 100 watts and a frequency response from 45 to 8000 Hz. Its design provides high efficiency, high linearity, low distortion, wide range and optimum cone resonance.

ALTEC



ALTEC 418B Loudspeaker

SPECIFICATIONS

Type:	Musical instrument loudspeaker	Magnetic Assembly —	
Power Rating:	For sound system use with amplifiers having continuous power rating of up to 100 watts of program material	Magnet Weight:	2.4 pounds
Frequency Response:	45 Hz to 8000 Hz (see Figure 1)	Assembly Weight:	10.5 pounds
Pressure Sensitivity:	99 dB SPL measured at 4' on axis with 1 watt input of pink noise from 100 Hz to 10 kHz (Ref.: 0.0002 dyne/cm ²). Equal to EIA rating of 52 dB SPL at 30' from 1 milliwatt input. 98 dB SPL measured at 4' on axis with 1 watt input of pink noise from 100 Hz to 1000 Hz (Ref.: 0.0002 dyne/cm ²).	Magnet Type:	Alnico V
Impedance:	8 ohms (other impedances available in production quantities)	Flux Density:	13,000 gauss
Nominal Free-Air Cone Resonance:	55 Hz	Construction —	
Voice Coil Diameter:	3"	Frame (Basket):	Structurally reinforced die-cast aluminum
		Cone:	Molded fiber
		Cone Suspension:	High-compliance cloth surround with mechanical resistance
		Voice Coil:	Edge-wound aluminum ribbon
		Maximum Core Excursion:	1/2"
		Diameter:	15-5/16" (38.89 cm)
		Weight:	14 pounds, 6 ounces (8.53 kg)
		Mounting Data —	
		Mounting Hole Diameter:	13-5/8" (may be either front or rear mounted)
		Mounting Bolt Centers:	4 holes equally spaced on 14-9/16"-diameter circle
		Loudspeaker Depth:	7" (17.78 cm)

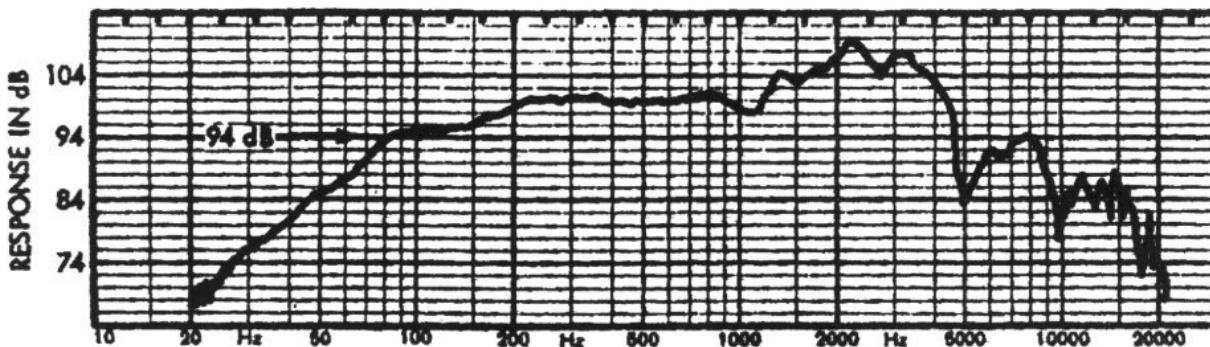

Figure 1. 418B Frequency Response Measured at 4' on Axis with 1 Watt Input

ARCHITECT'S AND ENGINEER'S SPECIFICATIONS

The musical instrument loudspeaker shall have a maximum diameter of 15-5/16" and shall weigh 14 pounds, 6 ounces. It shall have a structurally reinforced die-cast aluminum frame which shall be rigid enough to permit front or rear mounting. The voice coil shall be 3" in diameter, of edge-wound aluminum ribbon, and shall operate in a magnetic gap having a flux density of 13,000 gauss. The loudspeaker shall have an Alnico V permanent magnet weighing not less than 2.4 pounds. The magnetic structure shall have a metal dust cover to protect it from dirt, iron particles and magnetic dust. The cone-surround area shall be of high-compliance cloth. The musical instrument loudspeaker shall meet the following performance criteria. Power rating, up to 100 watts of continuous program material. Frequency response, uniform from 45 to 8000 Hz when loudspeaker is mounted in suitable enclosure. Pressure sensitivity; 99 dB SPL when measured at 4' on axis with 1 watt input of pink noise from 100 Hz to 10 kHz; 98 dB SPL when measured at 4' on axis with 1 watt input of pink noise from 100 Hz to 1000 Hz (Ref.: 0.0002 dyne/cm²). Equivalent EIA rating, 52 dB SPL at 30' from 1 milliwatt input. Impedance, 8 ohms. Nominal free-air cone resonance, 55 Hz.

The musical instrument loudspeaker shall be the ALTEC Model 418B.