

JC-120/JC-160 SERVICE NOTES

Fifth Edition

This Service Notes makes Fourth Edition (Printed MAR. 20, 1979) obsolete and includes its contents in PART 2 of this edition.

PART 1 (PP. 1 thru 4)	JC-120	258100 and up (except USA) 293150 and up (USA only)
	JC-160	254510 and up
PART 2 (PP. 5 thru 8)	JC-120	789500-248099 950100-283149 (USA only)
	JC-160	782921-244509
	JC-120A	810600-001099

SPECIFICATIONS

Output	120W (rms)	Tone Control Range . . .	TREBLE 17dB @10kHz MIDDLE 13dB @350Hz BASS 14dB @50Hz BRIGHT 5dB @10kHz (VOLUME at center)
Speaker	JC-120 30cm x 2 JC-160 25cm x 4	Dimensions	JC-120 (w/o caster) 750(W) x 540(H) x 270(D) mm 29-1/2 x 21-1/4 x 10-5/8in JC-160 750(W) x 700(H) x 300(D) mm 29-1/2 x 27-1/2 x 11-3/4in
Power Consumption . . .	400VA	Weight	JC-120 28kg, 62 lbs JC-160 35kg, 77 lbs
Input Sensitivity	HIGH 20mV (@ 1kHz) LOW 60mV MAIN IN 800mV		
Line Output	Level 100mV @1kHz Impedance 100Ω		
Residual Noise	7-35mV per channel (varies with controls setting)		

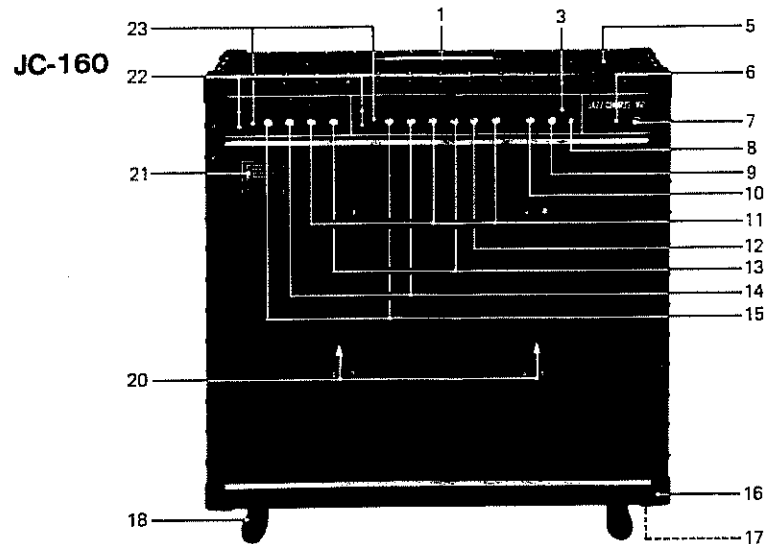

REAR

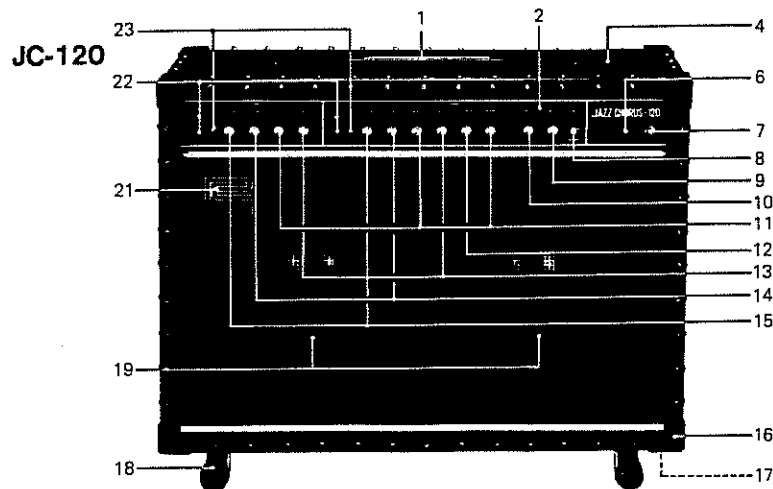

No.	Part Name (Part Number)	No.	Part Name (Part Number)
1	Handle H-30 w/cover (12319401)	13	BASS Pot. EVH-6PA361AF5 250kA (13219239)
2	Panel (2221020900) Chassis	14	TREBLE Pot. EVH-6PA361BF5 250kA (13219282)
3	Panel (2221021000) (2281019900)	15	VOLUME Pot. EVH-6PA361B16 1MB (13219283)
4	Cabinet Ass'y (2101013401) w/ caster Cabinet Ass'y (2101015501) w/o caster	9-15	Knob (2247012300)
5	Cabinet Ass'y (2101013501) w/ caster Cabinet Ass'y (2101015701) w/o caster	16	Corner Protector (2234020200)
6	LED SLP-4B (15029114)	17	Rubber Foot G-5
7	POWER Switch DS-239 6P (13139511) 100V S-7B-7 (13139507) 117V S-33 (13139505) 220/240V2P WD-13129 (13139515) 240V3P	18	Caster 420K-R50φ (detachable)
8	VIB/CHORUS Switch Knob ESL-3654 (13139140) (2247011500)	19	Speaker 30-103D (2241020400)
9	VIB DEPTH Pot. EVH-6PA361B15 100kA (13219213)	20	Speaker 25-33D (2241030200)
10	VIB SPEED Pot. EVH-6PA361A15 100kA (13219210)	21	Badge (2251040200)
11	MIDDLE, REVERB Pot. EVH-6PA361B14 10kA (132129212)	22	Jack SG-7615#1 (13449105)
12	DISTORTION Pot. w/SW EVH-6PGK20C14 10kA (13219801)	23	BRIGHT Switch SLR-022 (13139109)
		24	Fuse Holder SN-2059 (12199514) 100/117V or FH-032 SN-2250 (12199515) 220/240V or FH-033

PRE-MAIN BOARD CH-2
(7011629000)
(pcb 2291023801)

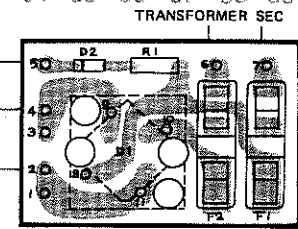
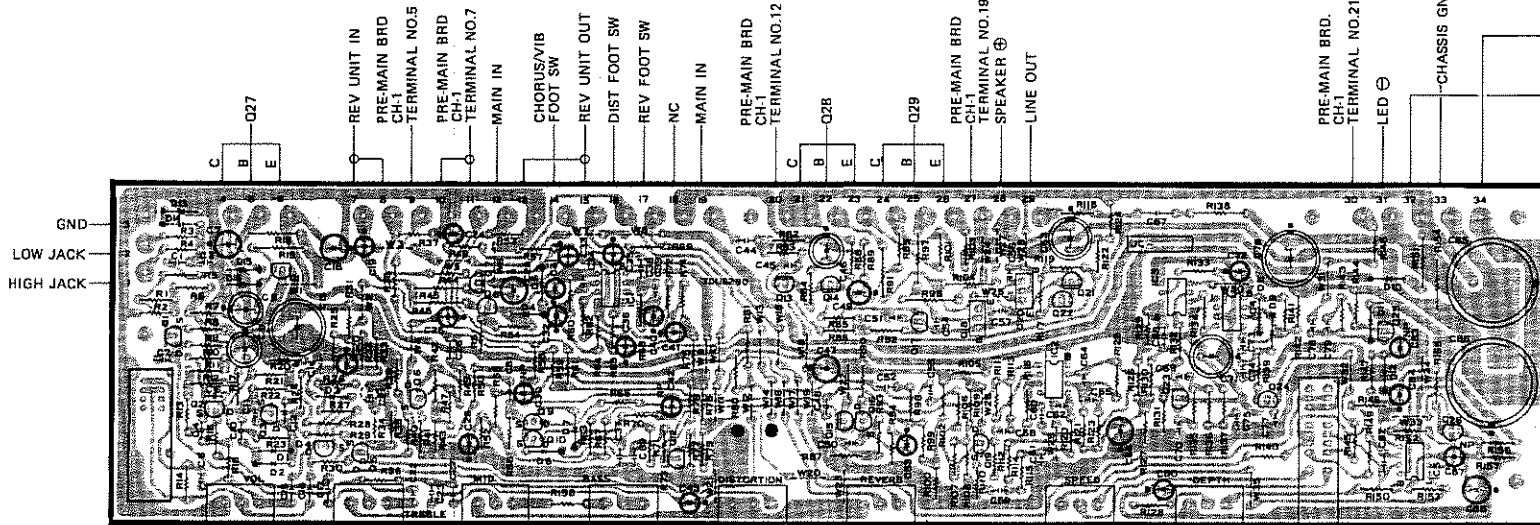

	FUSE	FUSE HOLDER
100/117V	MGC 6A	TF-757
220/240V	CEE T3.15A	TF-758

POWER SUPPLY BOARD
100/117V (7011627100)
220/240V (7011627400)
(pcb 2291023901)

- SLR-022
- EVH-6PA361BF5 250k Ω
- EVH-6PA361AF5 250k Ω
- EVH-6PA361B14 10k Ω
- EVH-6PA361A15 100k Ω
- ESL-3654

PRE-MAIN BOARD CH-1
(7011628000)
(pcb 2291023701)

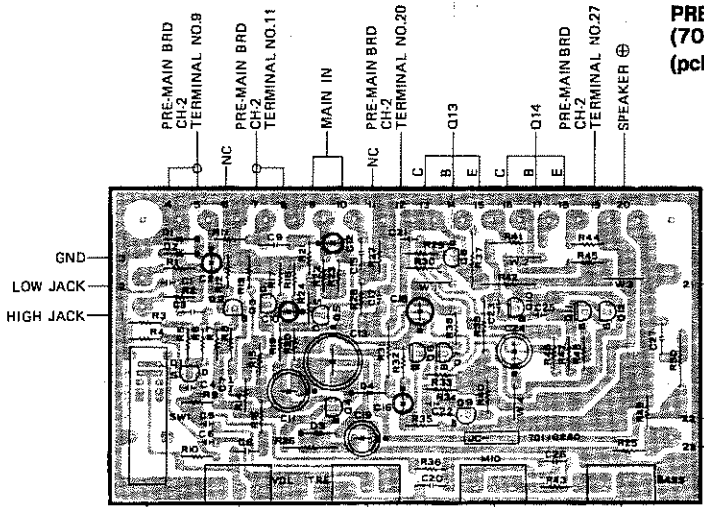

- SLR-022
- EVH-6PA361BF5 250k Ω
- EVH-6PA361AF5 250k Ω
- EVH-6PA361B14 10k Ω

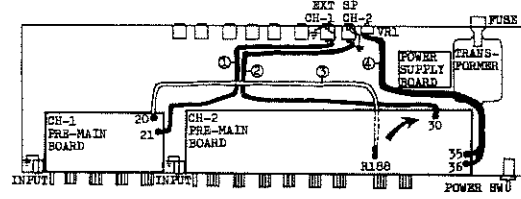

IMPORTANT
As shown on P.7, earlier speaker system (built in and EXT) is parallel connection.

When replacing PRE-MAIN BOARDs shown in the fourth edition with PCB on this page, take the following procedure.

REPLACING CH-1 ONLY

1. Remove insulating rubber from CH-1 INPUT jacks (Hi and Lo) and CH-1 EXT SP jack.
2. Place metal washer (1.6mm thick) between chassis (inside) and the jacks. Remount the jacks which are now chassisgrounded.
3. Remove wire ①. It becomes redundant and CH-1 terminal 21 on new PCB should be left unconnected.
4. Resolder wire ② at 20 of the new PCB.
5. Remove R25 (100 Ω) connecting to terminal 23 of new PCB.

REPLACING CH-2 ONLY

1. Replace jack washers of CH-2 INPUT and EXT SP in the same manner as for CH-1.
2. Remove wire ③. Solder wire ④ from CH-1 terminal 20 at 30 of new CH-2.
3. Delete wire ⑤ and VR1 (terminals 35 and 36 are absent on new CH-2).
4. Remove RB1 (100 Ω) connecting to terminal 29 of old PCB and solder the 100 Ω across terminal 29 and IC3 pin5 (GND) of the new PCB.

NOTE: New CH-2 PCB requires no adjustments.

REPLACING CH-1 and CH-2

1. Replace jack washers, referring to above paragraphs.
2. Remove wires ① ② ③. Rewire the remainder; most of wiring arrangement is similar to that on previous PCBs. Make sure of speaker connection and associated terminals:
CH-1 ... 20 and 21, CH-2 ... 28 and 30.

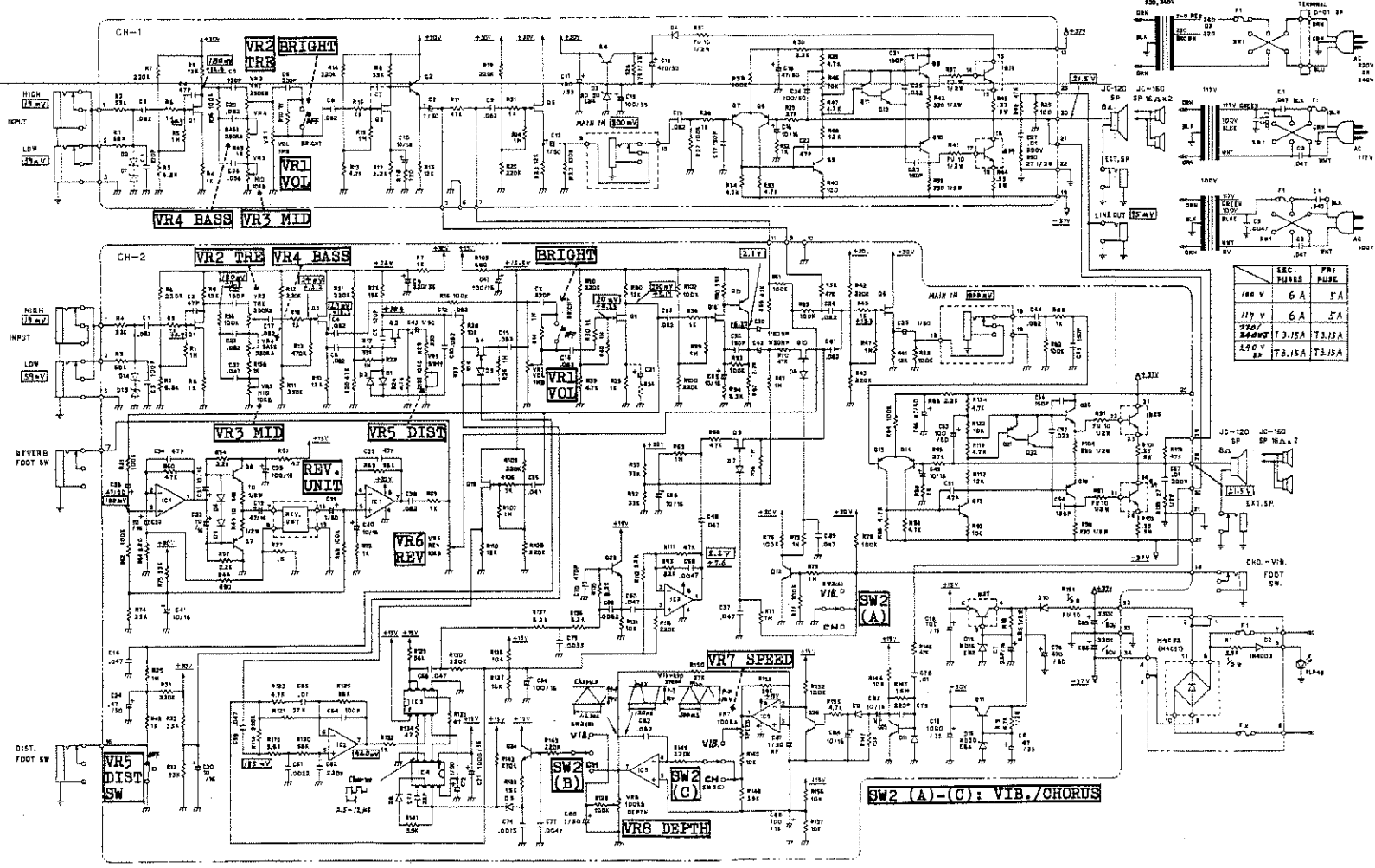

CH-1		CH-2	
Q1, 3, 5 : 2SK117-GR	D3: RD-30EB4	Q1-3, 5, 6, 16, 19: 2SK117-GR	Q20 : 2SD669-AC
Q2, 12 : 2SC2240-GR	D4: 1N4003 or S5500G	Q4, 9, 10 : 2SK246-GR	Q22 : 2SC2240-GR
Q4 : 2SC667-C		Q7 : 2SB647-C	Q27 : 2SD313E
Q6, 7, 11 : 2SA970-GR		Q8, 11 : 2SD667-C	or 2SC1624, 2SD880
Q9 : 2SC2229		Q12, 23-26 : 2SC1815-GR	Q28, 29 : 2SD845 or 2SC3182,
Q8 : 2SD669-AC		Q13-15, 21 : 2SA970-GR	2SC2773, 2SC2564
Q10 : 2SB649-AC		Q17 : 2SC2229	IC1, 2, 5 : NJM4558DD
Q13, 14 : 2SD845 or 2SC3182, 2SC2773, 2SC2564		Q18 : 2SB649-AC	IC3 : MN3007

Secondary Winding Ratings (DC) 37V x 2 @2.5A 3300μF INPUT

Signal Voltages Taken Under Conditions:
 Input 1kHz sine
 Tone controls BASS-FCW
 TRE-FCW
 MID-FCW
 JACK COLD terminals not connected to PCB terminals are to chassis.

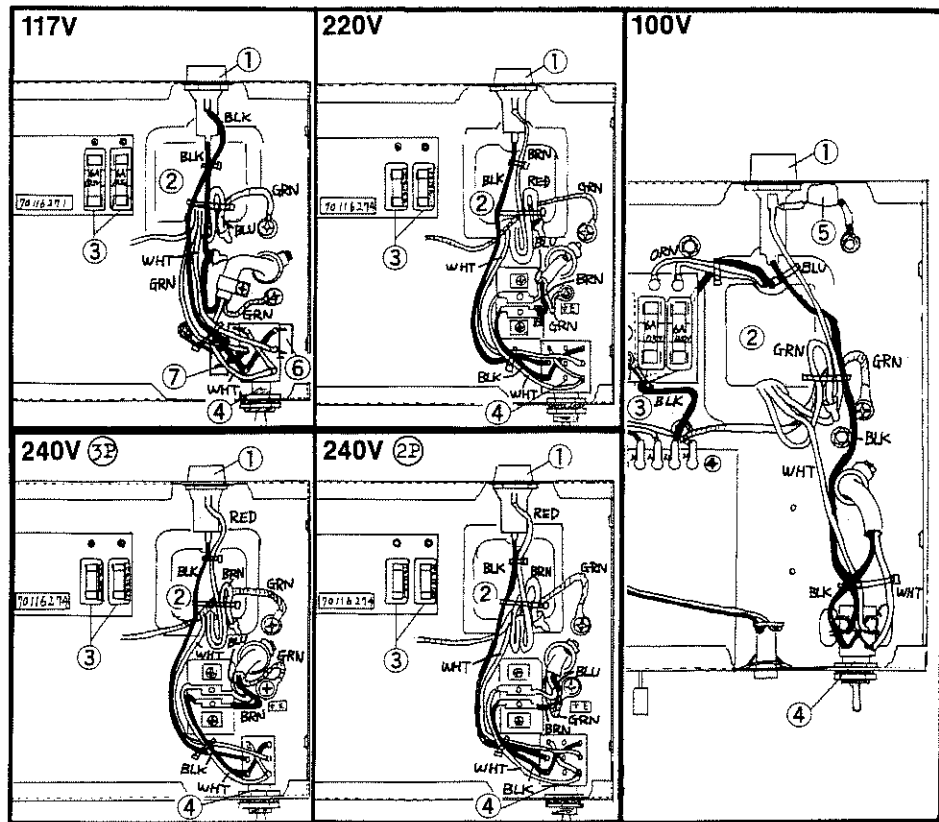

	100/117V	220/240V
1. PRI FUSE FUSE HOLDER	MGC 5A SN-2059 or FH-032	CEE T3. 15A SN-2250 or FH-Q33
2. SEC FUSE FUSE HOLDER	MGC 6A TF-757	CEE T3. 15A TF-758
3. TRANSFORMER	(22450273N0)	(22450274D0)
4. POWER SWITCH	DS-239 6P (100V) S-7B-7 (117V)	S-33 (220/240VJ) WD-13129 (240V3P)
5. Line Capacitor	ECQ-M6472MZ (100V)	
6. Line Capacitor	ECQ-UC1A473MC (117V)	
7. Line Capacitor	ECQ-UC1A472MC (117V)	

PARTS LIST

Parts marked with • are the same as those on early model. Only part numbers changed.

CABINET ASSEMBLY
(Including Handle, Badge, Corner Protector, Rubber Feet and Baffle Board)

- 2101013401 JC-120
- 2101015501 JC-120 (with caster)
- 2101013501 JC-160
- 2101015701 JC-160 (with caster)

PANEL

- 2221020900 JC-120
- 2221021000 JC-160
- 2281019900 Chassis

SPEAKER

- 2241020400 30-103D JC-120
- 2241030200 25-33D JC-160

SWITCH

- 13139511 DS-239 6P POWER 100V
- 13139507 S-7B-7 POWER 117V
- 13139506 S-33 POWER 220/240V2P
- 13139515 WD-13129 POWER 240V3P
- 13139109 SLR-022 BRIGHT
- 13139140 ESL-3654 VIB/CHORUS

JACK

- 13449105 SG-7615#1

POWER TRANSFORMER

- 22450273N0 100/117V
- 22450274D0 220/240V

REVERB UNIT

- 12389101 Z-3F

FUSE

- 12559119 MGC 5A pri. 100/117V
- 12559120 MGC 6A sec. 100/117V
- 12559516 CEE T3.15A 220/240V

FUSE HOLDER

- 12199514 SN-2095 pri. 100/117V
or FH-032
- 12199515 SN-2250 pri. 220/240V
or FH-033
- 12199518 TF-757 sec. 100/117V
- 12199519 TF-758 sec. 220/240V

PCB ASSEMBLY

Compatible with the preceding revision only.
See P.2 for detail.

- 7011628000 PRE-MAIN BOARD CH-1
(pcb 2291023701)
- 7011629000 PRE-MAIN BOARD CH-2
(pcb 2291023801)
- 7011627100 POWER SUPPLY BOARD 100/117V
(pcb 2291023901)
- 7011627400 POWER SUPPLY BOARD 220/240V
(pcb 2291023901)

POTENTIOMETER

- 13219212 EVH-6PA361B14 10kB
MIDDLE, REVERB
- 13219210 EVH-6PA361A15 100kA
VIB. SPEED
- 13219213 EVH-6PA361B15 100kB
VIB. DEPTH
- 13219239 EVH-6PA361AF5 250kA
BASS
- 13219282 EVH-6PA361BF5 250kB
TREBLE
- 13219283 EVH-6PA361B16 1MB
VOLUME
- 13219801 EVH-6PGK20C14 10kC w/SW
DISTORTION

IC

- 15189102 NJM-4568DD
- 15219205 MN-30078BD
- 15169504 MN-3101
CLOCK GENERATOR/DRIVER

TRANSISTOR

- 15119111 2SA970-GR
- 15119602 2SB647-C
- 15119604 2SB649-AC
- 15129114 2SC1815-GR
- 15129409 2SC2229
- 15129120 2SC2240-GR
- 15129602 2SD667-C
- 15129604 2SD669-AC
- 15129820 2SD313-E
or 2SC1624, 2SD880
- 15129818 2SD845
or 2SC3182, 2SC2773, 2SC2564

FET

- 15139106 2SK117-GR
- 15139112 2SK246-GR

DIODE

- 15019103 1S2473
- 15019205 1N-4003 or S5500G
- 15019560 RD16EB2 zener
- 15019582 RD30EB4 zener
- 15019238 M4C-51 or M4C-52 rectifier
- 15029114 SLP-4B LED

CAPACITOR

- 13659234J0 NM50VNSN3300MA2 3300µF/50V
electro.
- 13549625M0 ECO-M2103KZ 0.01µF/200V
polypropylene
- 13549871M0 ECO-M6472MZ 0.0047µF/600V
polypropylene
- 13589452M0 ECQ-UC1A472MC 0.0047µF
polypropylene
- 13589453M0 ECQ-UC1A473MC 0.047µF
polypropylene

RESISTOR

- 13869301 0.33Ω 5W cement
- 13829802M0 ERD-12FJ 27Ω¼W non-flammable
- 12559702 FRNB 10Ω¼W fusible

JC-120/JC-120A R&P, JC-160

SERVICE NOTES

APPLICABLE TO FOLLOWING SERIAL NUMBERS

JC-120 ————— 789500 — 248099
 JC-120A R&P ————— 810600 — 001099 *Fourth Edition*
 JC-160 ————— 782921 — 244509

SPECIFICATIONS

OUTPUT POWER	-----	22V RMS	per channel	into 8-ohm
INPUT SENSITIVITY	-----	HIGH	LOW	MAIN IN
		22mV	72mV	700mV
		38mV	@ 1kHz	
		11mV	@ 100Hz	
			@ 10kHz	
INPUT IMPEDANCE	-----	220k-ohm	82k-ohm	MAIN IN
			@ 1kHz	68k-ohm
LINE OUTPUT	-----	Level	100mV	IMPEDANCE
			@ 1kHz	100-ohm
RESIDUAL NOISE	-----	9-20mV	per channel (varies with controls setting)	
TONE CONTROL RANGE	-----	TREBLE	38dB	@ 10kHz
		MIDDLE	2dB	@ 1kHz
		BASS	18dB	@ 100Hz
		BRIGHT	4dB	@ 10kHz
				VOLUME at center
POWER CONSUMPTION	-----	500VA		
DIMENSIONS	-----	JC-120	750W x 540H x 270Dmm (29.6 x 21.2 x 10.6 in)	
		JC-120A R & P	774W x 634H x 270Dmm (30.5 x 25 x 10.6 in)	
		JC-160	750W x 700H x 240/300Dmm (29.5x27.6x94/118 in)	
WEIGHT	-----	JC-120	28Kg (62 lbs)	JC-120A R&P
		JC-160	35Kg (77 lbs)	40Kg (88 lbs)

JC-120/JC-120A R&P (Photo)

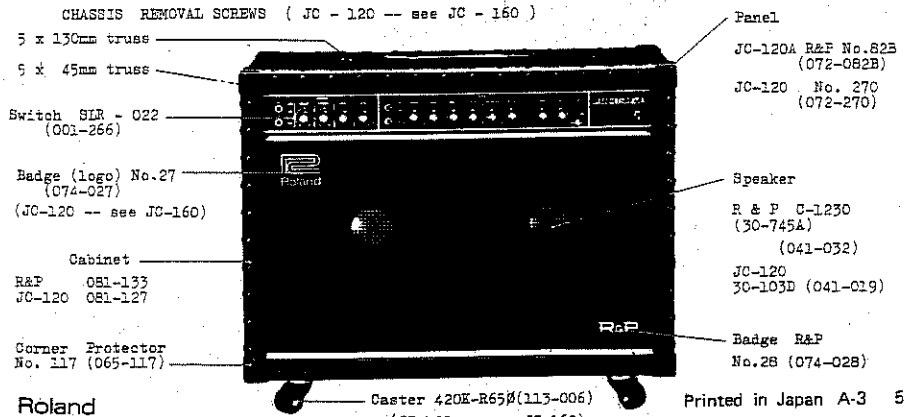

PART COMMON TO JC-120, JC-120A R&P and JC-160

PARTS COMMON to ALL THREE MODELS are only once rather than being shown in each photograph.

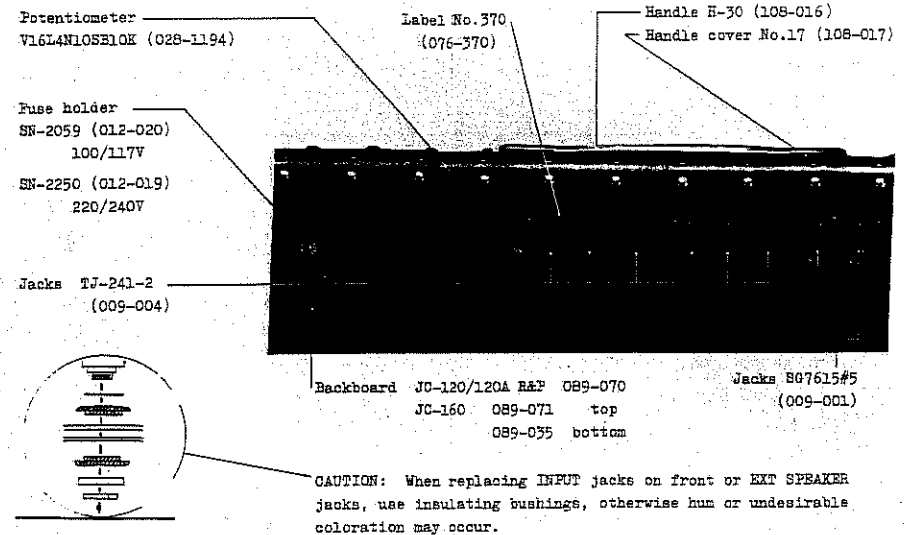

JC-160

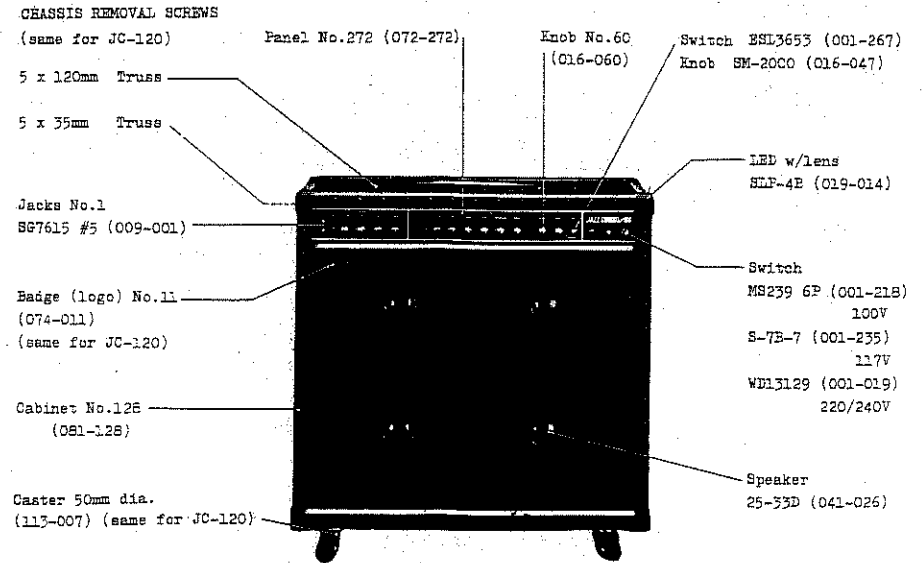

* Read C147 as C141

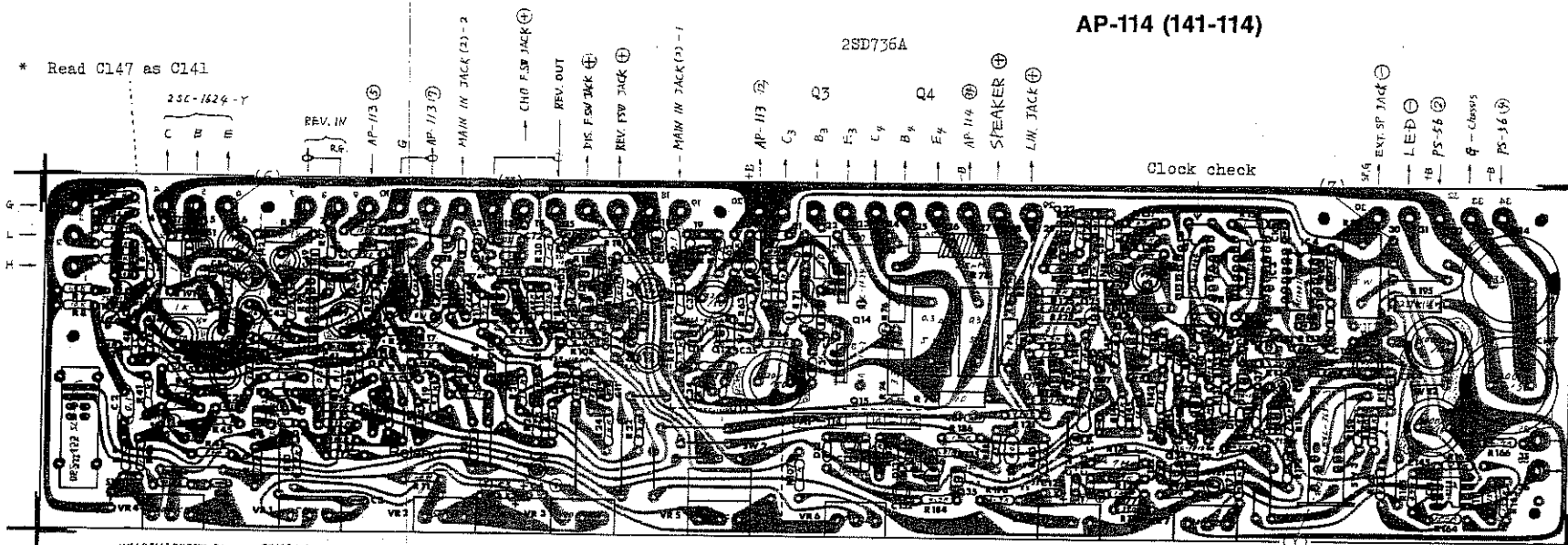

- V16L4PH2DN20KC B100K (028-1173)
- M16L4PH2DN20KC B10K (028-1174)
- V16L4PH2DN20KC B5K (028-1177)
- V16L4PH2DN20KC B100K (028-1162)
- R16L4PH2DN20KC B10K (028-502)
- V16L4PH2DN20KC B10K (028-1176)
- V16L4PH2DN20KC B10K (028-1183)
- V16L4PH2DN20KC B10K (028-1174)

NOTE: AP-114 (X)---(Y) (Z)---(Z) jumper wired

AP-113 (141-113)

IMPORTANT
If, as a substitutive for this board, PCB ASS'Y 701162800 or pcb 22910237** is supplied, see page 2 for replacement procedure.

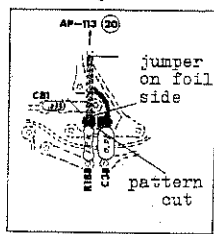

CHECKING & ADJUSTMENT

CHORUS ADJUSTMENT
Adjust VR1 (rear panel) for 1.5 sec (0.77Hz) at R161
SENSITIVITY Chorus starts to effect with 100mV rms output at channel 1 speaker

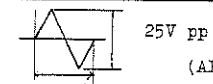

BBD OUTPUT ADJUSTMENT
Clock Composition Elimination
Adjust VR9 (trimpot) for fig. at R137(AP-114)

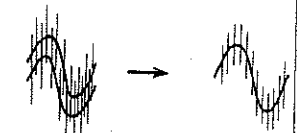

CLOCK OSCILLATOR 15V pp
Sweep Range at IC3 pin 1 (CP-2)
Vibrato 65k - 130kHz
Chorus 50k - 220kHz

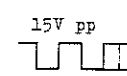

VIBRATO OSCILLATOR 25V pp
Frequency at Q33 C 1.8 - 9Hz

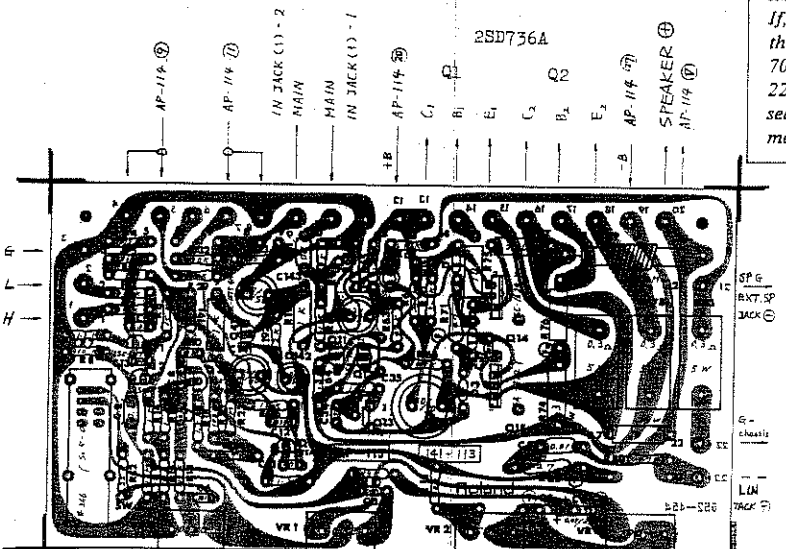
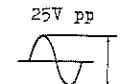

- V16L4PH2DN20KC B100K (028-1173)
- V16L4PH2DN20KC B50K (028-1174)
- V16L4PH2DN20KC B5K (028-1177)
- V16L4PH2DN20KC B100K (028-1162)

PS-56 (146-056)

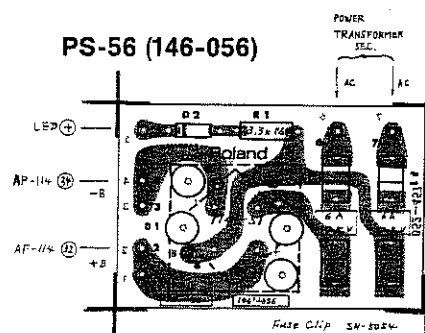

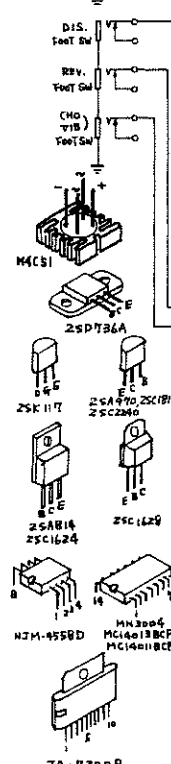
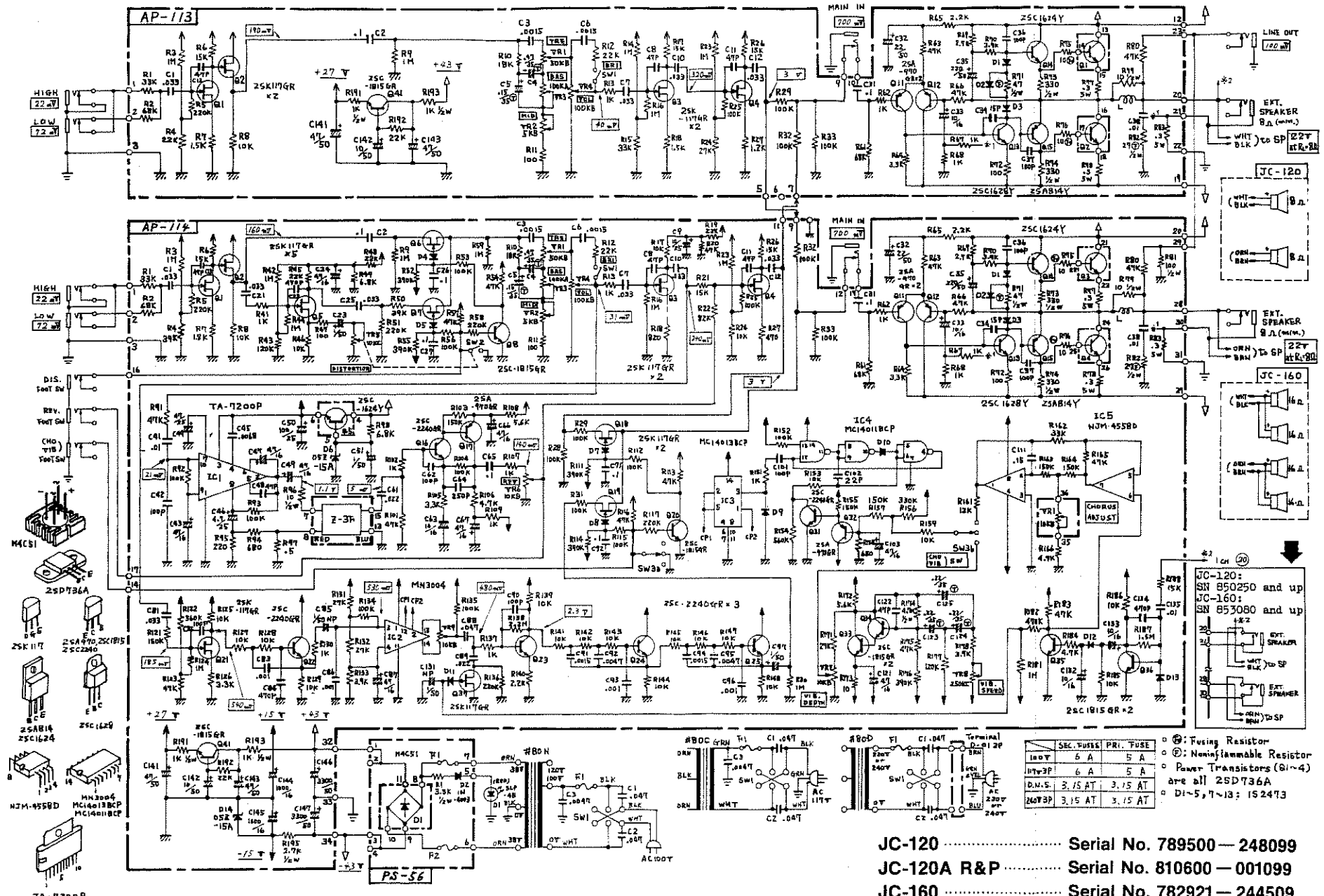

	SEC. FUSES	PRI. FUSE	
100V	5 A	5 A	
117V3P	6 A	5 A	
D.N.S.	3.15 AT	3.15 AT	
240V3P	3.15 AT	3.15 AT	

* Ⓢ: Fusing Resistor
 * Ⓡ: Nonflammable Resistor
 * Power Transistors (G1~4) are all 2SD736A
 * D1-5, 7-13: 1S2473

JC-120 Serial No. 789500 — 248099
 JC-120A R&P Serial No. 810600 — 001099
 JC-160 Serial No. 782921 — 244509

AC CONNECTIONS

117V

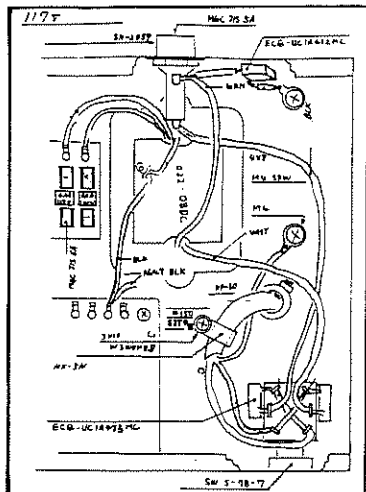

117V

Fuse
prim.
MGC JIS 5A
(008-009)
sec. MGC JIS 6A
(008-010)

Power transformer
022-080C

Capacitors
ECQUC1A472MC
(035-107)
ECQUC1A473MC
(035-108)

220/240V

Fuse
CEE 3.15AT
(008-072)

Power transformer
(022-080D)

220/240V

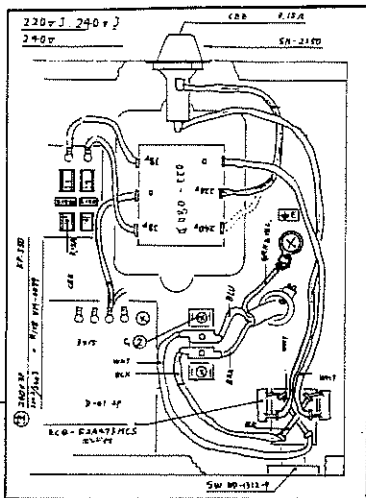

Capacitor
ECQE2A473MCS
(035-310)

100V

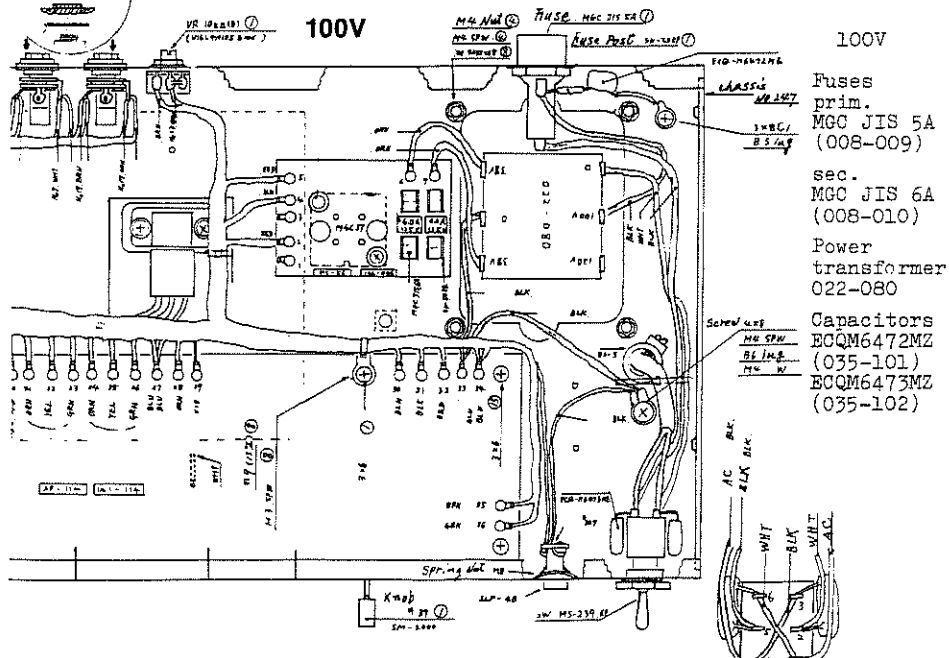

100V

Fuses
prim.
MGC JIS 5A
(008-009)
sec.
MGC JIS 6A
(008-010)

Power
transformer
022-080

Capacitors
ECQM6472MZ
(035-101)
ECQM6473MZ
(035-102)

PARTS LIST

Please read new PARTS LIST on p. 1 for reference.

JC-120	081-127	Cabinet no.127
089-070	089-070	Backboard no.70
072-270	072-270	Panel no.270
131-068	131-068	Vinyl cover no.68
041-019	041-019	Speaker 30-103D
JC-120A R&P	081-133	Cabinet no.133
089-070	089-070	Backboard no.70
072-082B	072-082B	Panel no.82B
131-098	131-098	Vinyl cover no.98
041-032	041-032	Speaker C1230(30745A)
JC-160	081-128	Cabinet no.128
089-071	089-071	Backboard no.71 top
089-035	089-035	Backboard no.35 bottom
072-272	072-272	Panel no.272
131-073	131-073	Vinyl cover no.73
041-026	041-026	Speaker 25-33D
061-247	061-247	Chassis no.247
048-073	048-073	Heatsink no.73 2SD736A
053-311	053-311	Connector assy no.311 2SD736A
053-166	053-166	Connector assy no.166 Reverb 2SC1624
040-001	040-001	Reverb unit Z-3F
120-009	120-009	Sleeve nut no.9 3x13mm
121-017	121-017	Spring nut M8 P LED
047-025	047-025	Line cord strain relief EA-5
009-001	009-001	Jack SG7615 #5
009-004	009-004	Jack TJ-241-2
016-060	016-060	Knob no.60 rotary
016-047	016-047	Knob SM2000 lever
POWER TRANSFORMERS	022-080	PT no.80 100V
	022-080C	PT no.80C 117V
	022-080D	PT no.80D 220/240V
SWITCHES	001-218	MS239 6P power 100V
	001-235	S-7B-7 power 117V
	001-019	WD13129 power 220/240V
	001-266	SLR-022 lever BRI.
	001-267	ESL-3653 lever VIB/CHO
FUSES, FUSE HOLDERS	008-009	MGC 5A prim. 100/117V
	008-010	MGC 6A sec. 100/117V
	008-072	CEE 3.15AT 220/240V
	012-020	Holder SN2059 100/117V
	012-019	Holder SN2250 220/240V
	012-029	Clip SN5054 sec.

PCBs

052-307	LED mounting less parts
141-113	AP-113 etch mask 052-454
141-114	AP-114 etch mask 052-455
146-056	PS-56 etch mask 052-457

POTENTIOMETERS

028-1177	V16L4PH2DN20KC B5K MID.
028-1176	V16L4PH2DN20KC B10K REV.DPT.
028-1174	V16L4PH2DN20KC B50K TRE.
028-1173	V16L4PH2DN20KC B100K VOL.
028-1162	V16L4PH2DN20KC15A100K BASS
028-1183	V16L4PH2DN20KC15C250K SPEED
028-1194	V16L4N10SB10K CHORUS-adj.
028-502	EVH6PGK20C14 10KC w/sw DIS.
028-004	EVT44AAC0B14 (SR19R) trim.

RESISTORS

044-253A	MO-4P 0.3-ohm 5W wire wound
044-398	ERD-12FJ 27-ohm 1/4W nonflam.
044-401	ERD-12FJ 47-ohm 1/4W nonflam.
008-118	FRNB 10-ohm 1/4W fusing

CAPACITORS

032-092	0.15 mfd. tantalum
032-093	0.22 mfd. tantalum
032-095	0.47 mfd. tantalum
032-195	CE04DLH010NBPE 1 mfd. 50V
032-262	ECET50R332SW 3300 mfd 50V electrolytic larg can
035-103	ECQM2103KZ 0.01 mfd 200V polyester

TRANSISTORS

017-119	2SA970-GR or 2SA841-GR (except Q32)
017-030	2SA814-Y
017-123	2SC2240-GR or 2SC1681-GR (except Q31)
017-106	2SC1815-GR or 2SC373
017-028	2SC1628-Y
017-029	2SC1624-Y
017-134	2SD736A-(B) or (C)
017-103	2SK117-GR FET

DIODES

018-095	M4C-51 rectifier bridge
018-014	1S2473
018-018	1N4003
018-025	O5Z-15A zener
019-014	SLP-4B LED w/lens

ICs

020-028	TA7200P
020-170	MC-14011BCP
020-179	MC-14013BCP
020-063	MN-3004 BBD
020-064	NJM-4558DP or μ PC4558C

* For the parts on the cabinets, see page 1.

* Resistor of 1/4w, mylar and ordinary electrolytic capacitor are omitted.

 Roland®

11052

UPC 11052



100