

STEREO POWER AMPLIFIER

M-50

SERVICE MANUAL

FRONT PANEL

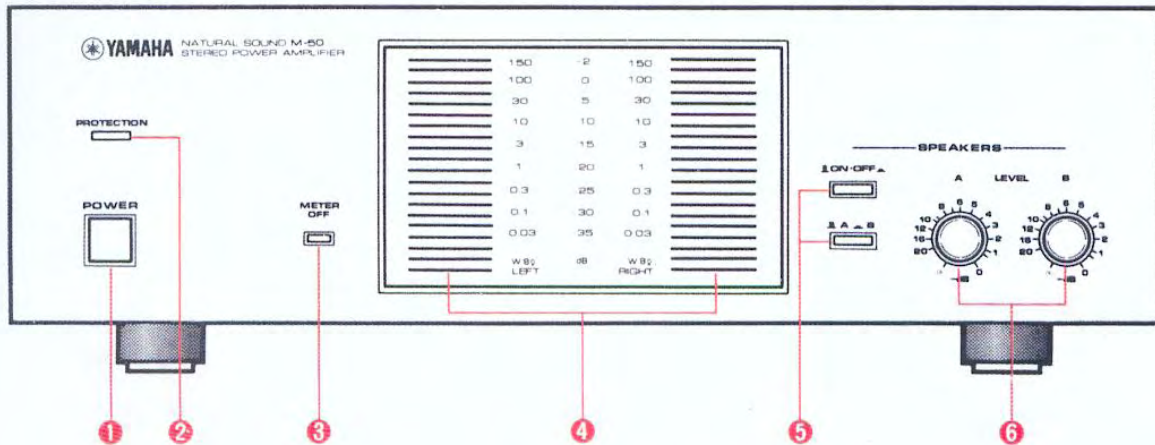

- ① POWER SWITCH
- ② PROTECTION INDICATOR
- ③ METER OFF SWITCH
- ④ PEAK POWER INDICATORS
- ⑤ SPEAKER SELECTION SWITCHES
- ⑥ SPEAKER LEVEL CONTROL

CONTENTS

REAR PANELS	1
SPECIFICATIONS	2
INTERNAL VIEW	3
DISASSEMBLY PROCEDURES	3
ADJUSTMENT	6
CONTROL C. BOARD/SCHEMATIC DIAGRAM (General model)	9
CONTROL C. BOARD/SCHEMATIC DIAGRAM (British, Australian and European models)	10
BLOCK DIAGRAM	11
PRINTED CIRCUIT BOARD	12
WIRING DIAGRAM	13
SCHEMATIC DIAGRAM	14

004453

REAR PANELS

▼ U.S. & CANADIAN MODELS

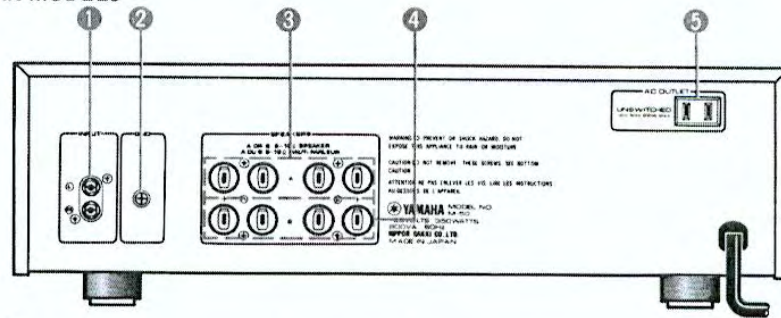

▼ GENERAL MODEL

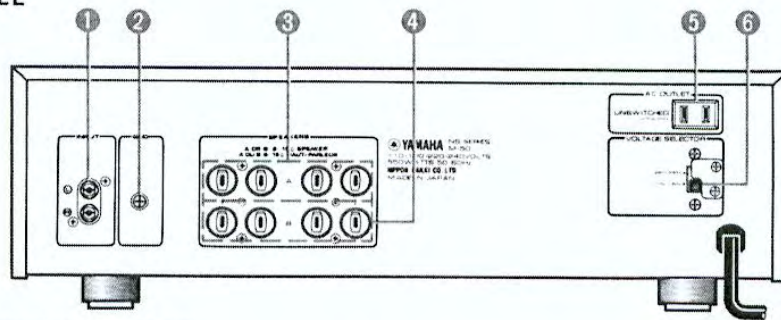

▼ BRITISH & AUSTRALIAN MODELS

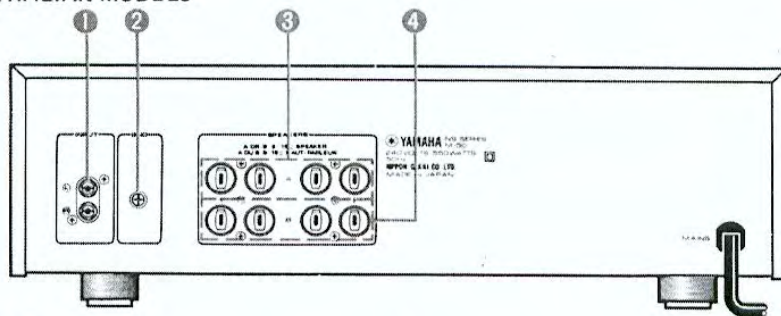

▼ EUROPEAN MODEL

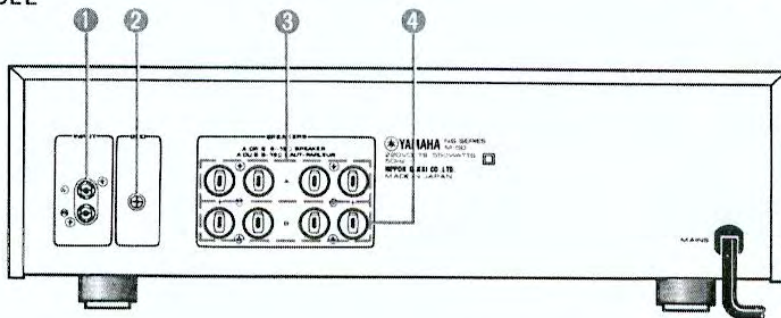

- ① INPUT TERMINAL
- ② GND TERMINAL
- ③ SPEAKER TERMINAL A
- ④ SPEAKER TERMINAL B

- ⑤ AC OUTLET
- ⑥ VOLTAGE SELECTOR

SPECIFICATIONS

Minimum RMS Output Power	
(8 Ω , 20Hz to 20kHz, 0.002% THD)	
(R), (U), (C)	120W + 120W
(G), (A), (B)	110W + 110W
4Ω Clipping Power (1kHz)	
	200W + 200W
Total Harmonic Distortion	
(8 Ω 1/2 Rated Power)	
20Hz	0.0005%
1kHz	0.0005%
20kHz	0.001%
50kHz	0.004%
100kHz	0.01%
IM Distortion Ratio	
(8 Ω , 1/2 rated power, 50Hz + 7kHz)	
	0.002%
Power Bandwidth	
(8 Ω 1/2 Rated Power 0.1% THD)	
	10Hz to 100kHz
Damping Factor	
(8 Ω 1kHz)	
	200
Frequency Response	
(8 Ω)	
	DC to 100kHz, -0.5dB
Input Sensitivity/Impedance	
(8 Ω Rated Power)	
(R), (U), (C)	1.1V/25k Ω
(G), (A), (B)	1.05V/25k Ω
Signal to Noise Ratio	
(IHF A Network, 8 Ω , Input Shorted)	
(R), (U), (C)	122dB
(G), (A), (B)	121dB

Channel Separation (Input Shorted)	
20Hz	100dB
1kHz	95dB
20kHz	70dB
Slew Rate	
	200V/ μ s
Power Supply	
(U), (C)	120V/60Hz
(G)	220V/50Hz
(A), (B)	240V/50Hz
(R)	110, 120, 220, 240V/ 50/60Hz
Power Consumption	
(U), (C)	350W/800VA
(G), (A), (B)	550W
(R)	200W
Dimensions (W x H x D)	
	435 x 380 x 133mm (17-1/8x14-15/16x5-1/4)"
Weight	
	11.8kg (26 lbs, 0.2 oz)

(U)U.S.A. model
 (C)Canadian model
 (R)General model
 (G)European model
 (B)British model
 (A)Australian model

Specifications subject to change without notice.

INTERNAL VIEW

TOP VIEW

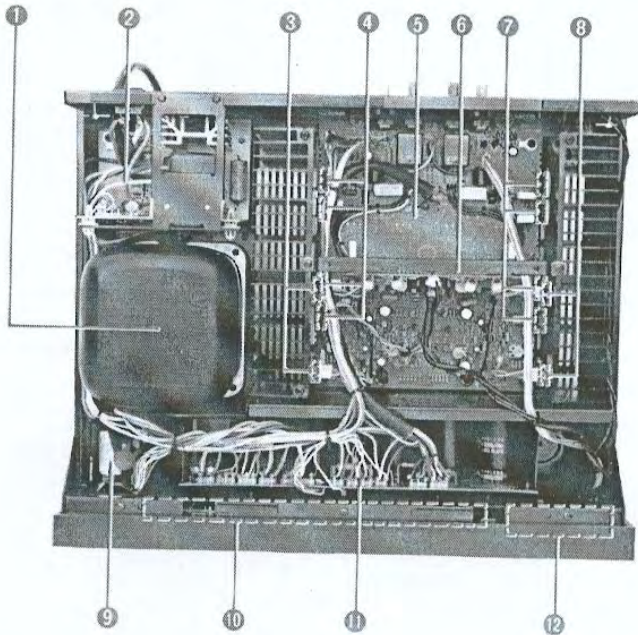

- ① POWER TRANSFORMER
 - U.S. model : GA64810
 - Canadian model : GA64820
 - European model : GA64830
 - British & Australian models : GA64840
 - General model : GA64850
- ② CONTROL CIRCUIT BOARD
- ③ DRIVE TRANSISTOR (Lch)
 - 2SA968
 - 2SC2238
- ④ POWER TRANSISTOR (Lch)
 - 2SA1146 (iA11460)
 - 2SC2706 (iC27060)
- ⑤ MAIN CIRCUIT BOARD (NA07758)
- ⑥ PREDRIVE CIRCUIT BOARD
- ⑦ POWER TRANSISTOR (Rch)
 - 2SA1146 (iA11460)
 - 2SC2706 (iC27060)
- ⑧ DRIVE TRANSISTOR (Rch)
 - 2SA968
 - 2SC2238
- ⑨ POWER SWITCH
- ⑩ METER CIRCUIT BOARD
- ⑪ ELECTROLYTIC CAP, CIRCUIT BOARD
- ⑫ PJ & VR CIRCUIT BOARD
 - U.S., Canadian & General Models: NA07918
 - European, British & Australian Models: NA07967

DISASSEMBLY PROCEDURES

1. Top cover removal

Remove screws ① and ② from the both left and right sides and screw ③ in Fig. 1. Slide cover away from the front panel, remove the top cover by lifting.

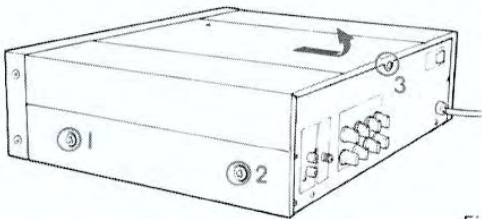

Fig. 1

2. Bottom cover removal

Remove screws ① through ⑨ in Fig. 2 and then remove the bottom cover.

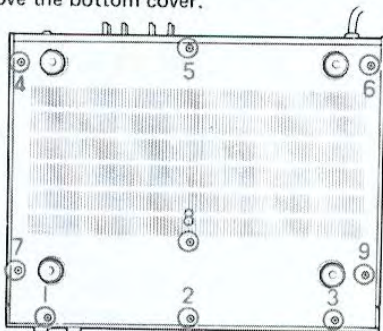

Fig. 2

3. Front panel removal

- a. Remove the SPEAKER LEVEL knobs.
- b. Remove screws ① through ③ in Fig. 3 and screws ① through ③ in Fig. 2, the front panel may be lifted out forward gently. When is performed, the illumination lamp of the power switch must be disconnected.

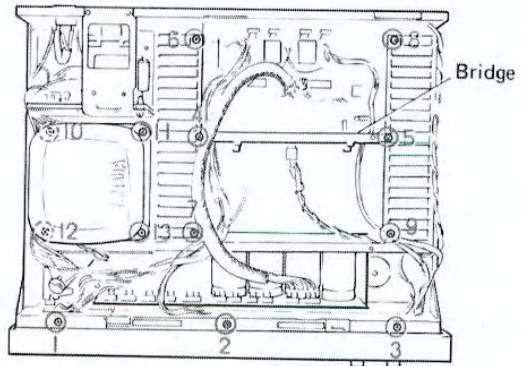

Fig. 3

4. PJ & VR circuit board removal

- a. Remove screws ① through ③ in Fig. 4 and remove the volume circuit board holder.
- b. Remove screws ④ and ⑤ and hexagonal nut ⑥ and ⑦ in Fig. 4, the VR circuit board may be removed.

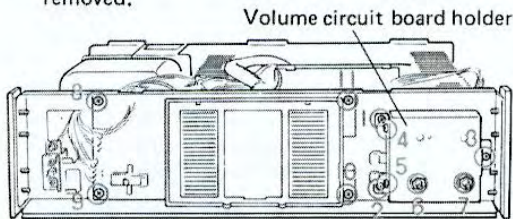

Fig. 4

- c. Remove screws ① and ② in Fig. 5 and then remove the PJ circuit board.

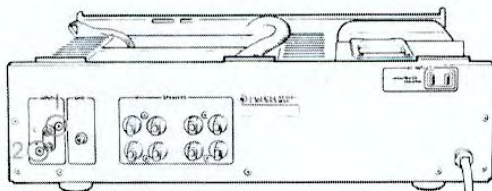

Fig. 5

5. Meter circuit board removal & replacement of parts

- a. Remove screws ⑧ through ⑪ in Fig. 4 and remove the meter circuit board, and then take off three illumination lamps of the meter circuit board.
- b. Remove the plastic rivets ① through ⑧ in Fig. 6 from the back side of the meter circuit board and remove the meter housing.

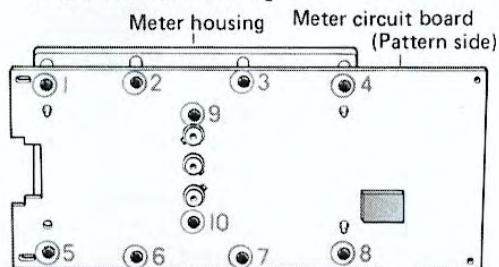

Fig. 6

- c. Detach one side of the adhesive tape which adheres the meter plate (It is difficult to set on just position if you detach the both left and right sides.), and open the meter plate as shown in Fig. 7.
- d. Remove plastic rivets ⑨ and ⑩ in Fig. 6 and re-remove the lamp reflector.
- * When mounting the lamp reflector, mount so that the "damper, shade" is placed under the lamp reflector.
- e. In this condition it is possible to replace IC503 to 506.

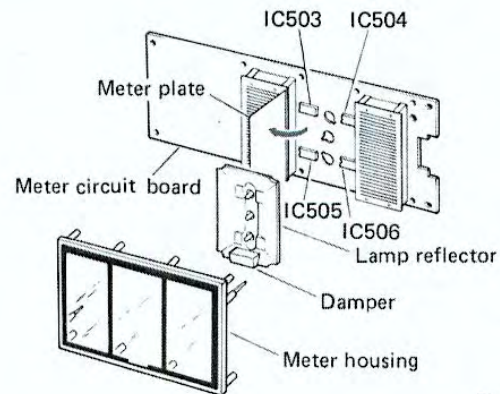

Fig. 7

6. Parts of the Electrolytic capacitor circuit board replacement

- a. Remove screws ① and ② in Fig. 8.

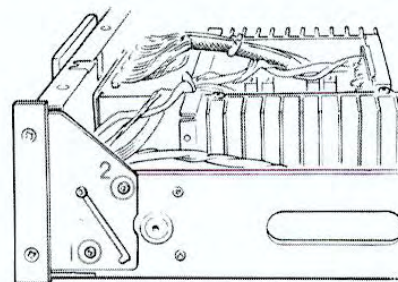

Fig. 8

- b. Open the sub-chassis as shown in Fig. 9. In this condition it is possible for you to check the power circuit board.
- c. Remove the screws ① and ② in Fig. 9.
- d. Remove the electrolytic capacitor circuit board and replace the parts of the circuit board.

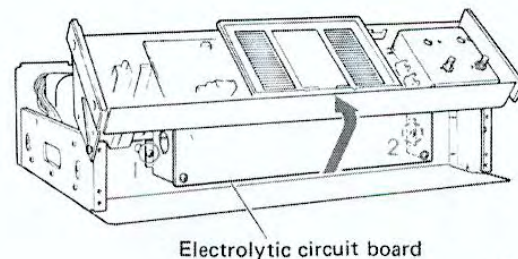

Fig. 9

7. Power transistor replacement (Rch)

- a. Detach the connectors ① and ② in Fig. 10 which are connected to the drive transistor.
- b. Unsolder the lead wires of the power transistor.
- c. Remove screws ④ and ⑤ in Fig. 3 and detach the bridge.
- d. Remove screws ⑧ and ⑨ in Fig. 3 and detach the heat sink.
- e. Remove screws ③ through ⑥ in Fig. 10 which fix the power transistors and then exchange the transistors.

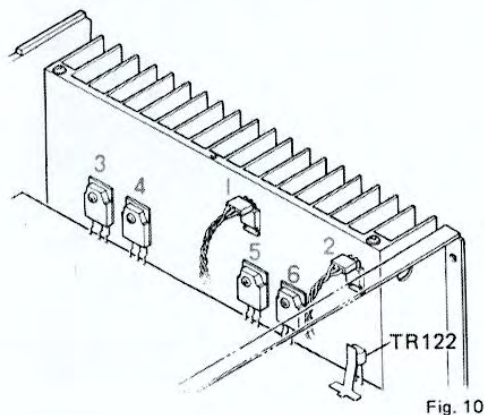

Fig. 10

* When mounting the power transistors, install a mica base between the heat sink and transistors so that the heat sink will not touch the case of the power transistor. Apply silicon grease to both sides of the mica base so that heat coupling between power transistors and the heat sink will be efficient. (Fig. 11).

Mounting TR135 ~ 142

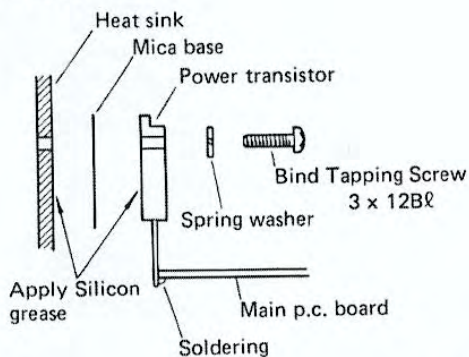

Fig. 11

- f. Replace the drive transistors as shown in Fig. 11. Use the isolation bushing as shown in Fig. 12 when mounting drive transistors.
- g. Mount the heat sink on which power and drive transistors have been secured. After the heat sink is secured with screws ⑧ and ⑨ in Fig. 3, solder the lead wires of power transistors to the main circuit board.
- * After the heat sink has been mounted, check that TR122 can sufficiently touch the heat sink. Apply silicon grease to the contact surface. When the heat coupling between power transistor and the heat sink is imperfect, the power transistors may be damaged thermal run away. (Fig. 10).
- h. Attach the connector to the drive transistor.
- * Be careful about the direction (B,C,E) of the connector. (Fig. 12)

Mounting TR131 ~ TR134

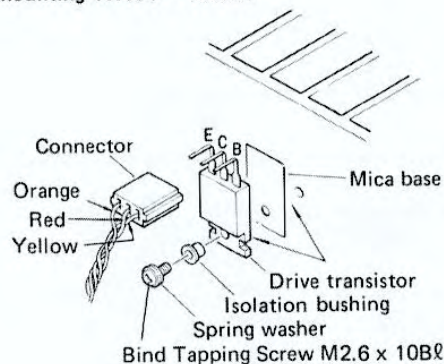

Fig. 12

8. Power transformer removal

- a. Remove screws ⑩ through ⑬ in Fig. 3 and remove the transformer cover.
- b. Detach the lead wires of the transformer.
- c. Remove screws ① through ④ in Fig. 13 and then remove the power transformer.

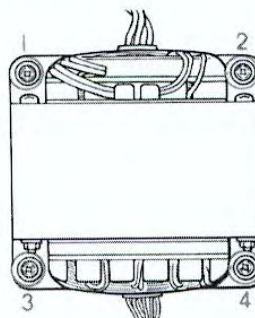

Fig. 13

ADJUSTMENTS

BEFORE COMMENCING

1. Make sure that primary supply voltage comes within $\ast 120V \pm 10\%$ (U, C models).
2. Proceed with the adjustments about 5 minutes after the power has been turned on to stabilize the operation of the amplifier.

\ast G model 220V
B, A models 240V

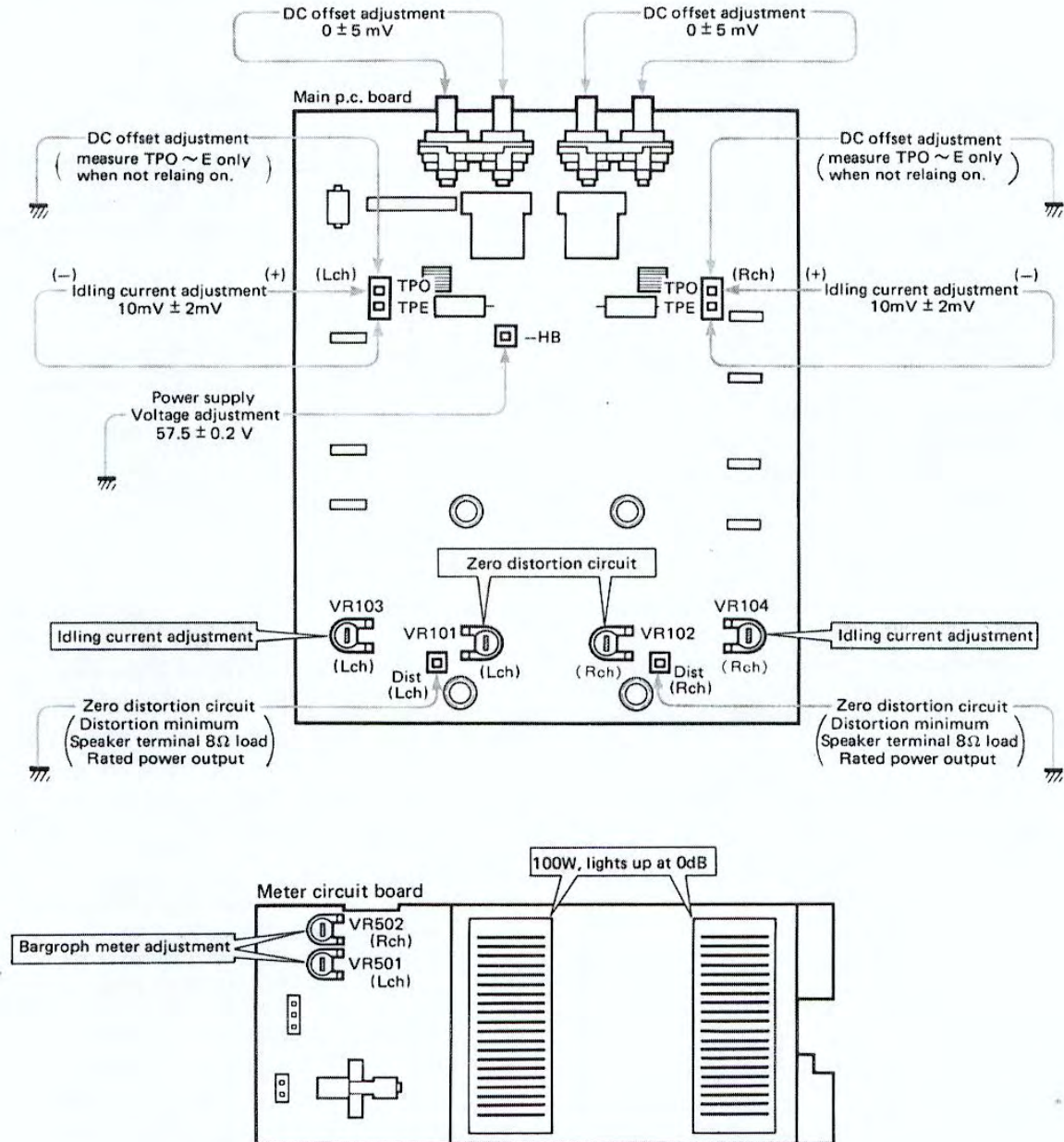

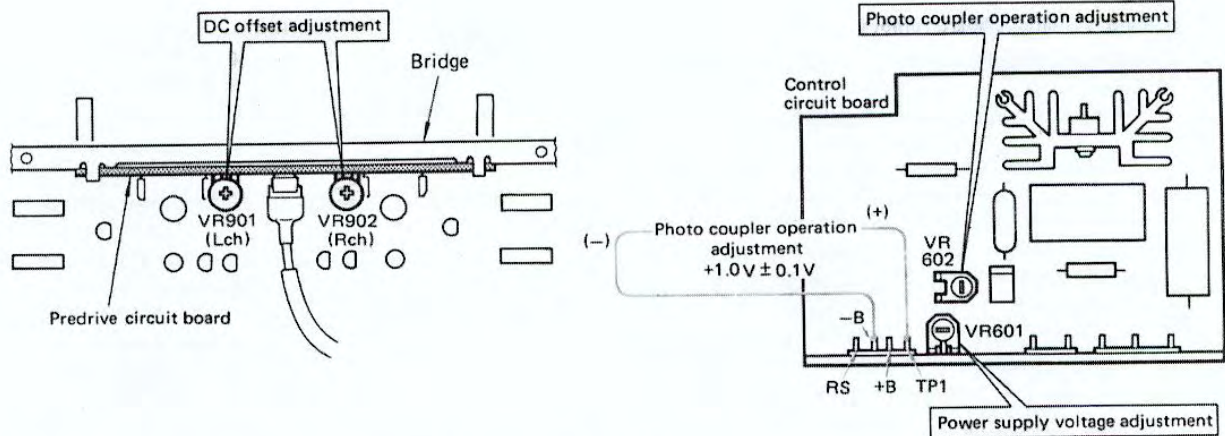

Step	Adjustment	Adjustment points	Test points	Rating	Remarks
1*	-B power supply voltage adjustment	Control circuit board VR601	Main circuit board -B(-) ~ E(+)	54.5V ± 0.2V [A,G,B] 56.5V ± 0.2V [U,C,R]	No load
2*	Photo coupler voltage adjustment	Control circuit board VR602	Control circuit board -B(-) ~ TP1(+)	+1.0V ± 0.1V	No load
3	DC offset adjustment	Predrive circuit board VR901(L) VR902 (R)	Speaker terminal TPO(+) ~ TPE(-) only when relay not on	0V ± 5mV	
4	Idling current adjustment	Main circuit board VR103 (L) VR104 (R)	Main circuit board TPO(+) ~ TPE(-)	10mV ± 2mV	No load
5	Bargraph meter adjustment	Meter circuit board VR501 (L) VR502 (R)	Speaker terminal 1kHz 100W (31.24dBm) 8Ω	Meter point 0dB	0.5dB decreasing, it is lit dimly.
6	Zero distortion circuit adjustment	Main circuit board VR101 (L) VR102 (R)	DIST ~ E (1kHz at SP terminal 8Ω load output power U,C,R 120W (32.03dBm) G,A,B 110W (31.66dBm)	After confirming minimum point of distortion, ad- just so that the dis- tortion comes minimum	Adjust as shortly as possible with taking notice of the load.

※ Accomplish steps 1* and 2* at the same time by using two digital multimeters.

● **Precautions in adjusting the control circuit board**

Note 1) Since the AC mains is connected directly to the control circuit board be particularly careful against electric shock.

Note 2) Always check voltages by measuring the voltage between the reference measuring point and check point.

Note 3) Use floating inputs for wave form measuring purposes. If the oscilloscope body is grounded the measuring circuit will be in danger of being short circuit. In this case, however, do not touch the oscilloscope body by hand since the voltage applied to the oscilloscope could possibly result in an electric shock.

CHECK POINTS

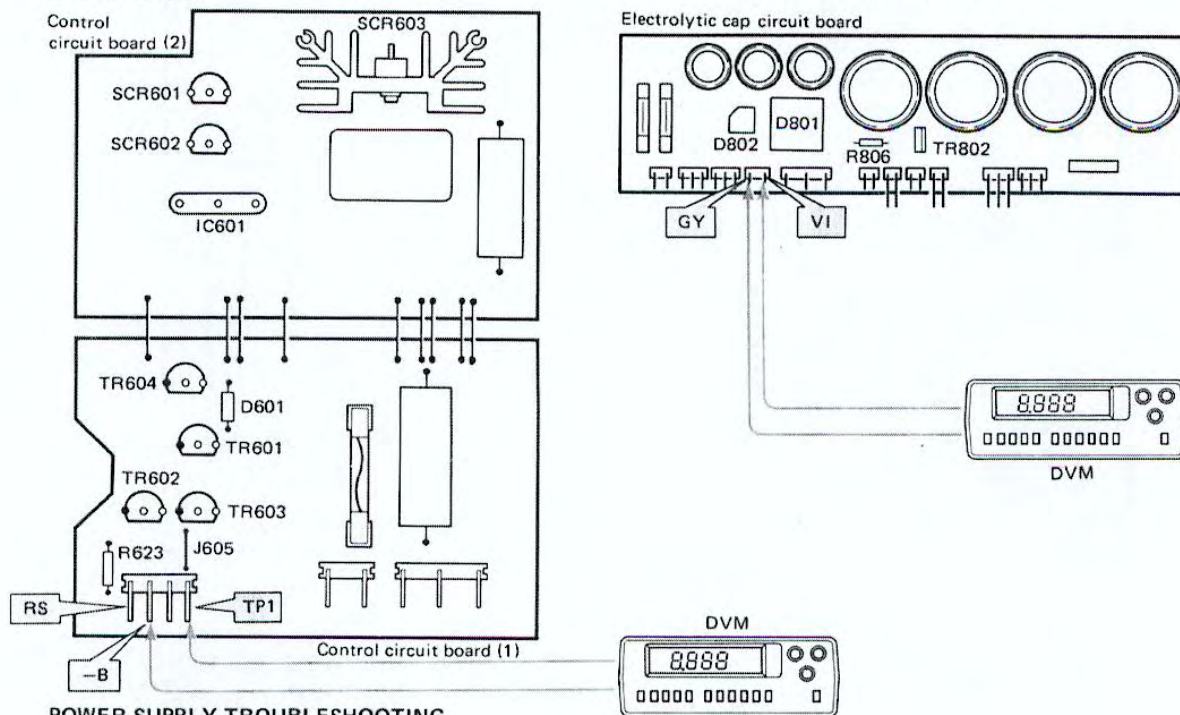

POWER SUPPLY TROUBLESHOOTING

■ **To Confirm Proper Operation of Control Circuit Board (1):**

- 1) Short between terminal TP1 and J605 with a jumper on control circuit board (1).
- 2) Connect a DVM across terminals GY and VI on the electric cap. circuit board.
- 3) Connect the unit to a Variac (Slide Transformer) and adjust mains voltage from 0V to *120V AC (U.C models) while monitoring the DVM. At 50V AC (U.C models) input to the unit, the DVM should read 0.45V AC and at 120V AC (U.C models) input it will read 5.5V AC/at 220V AC (R.G.B.A. models) input it will read 15.4V AC.
 - A. If the DVM reads 0V AC the most likely problem is an open SCR, Triac, or a short in the amplifier circuitry.
 - B. If the DVM reads the same as (or is proportional to) the AC input voltage, the most likely problem is a shorted SCR, Triac, or Control IC.

■ **To Confirm Proper Operation of Control Circuit Board (2):**

(This should be done only after Circuit (1) has been confirmed to be working properly).

- 1) Connect DVM across R623 and set to DCV. This resistor can be monitored at test point TP1 and -B.
- 2) Adjust the Variac from 50V AC to *120V AC (U.C models). The DVM should read 1.0V \pm 0.1V DC at *120V AC (U.C models)/2.0V \pm 0.1V at 220V AC (Ⓣ . Ⓢ models only), input to the unit.
 - A. If the voltage across R623 is high (or remains the same) when the Variac is adjusted from 50 to *120V AC, this indicates a shorted component (check transistors TR601, 602 & 603).
 - B. If there is 0V DC across R623, check the "reset" terminal (marked RS). This point should measure 0V DC for normal operation. If RS is at 0V DC, check TR601, TR604 and D601 first. If RS is not 0V DC, check TR802.

* R,A,G,B models 220V AC

CONTROL C. BOARD / SCHEMATIC DIAGRAM (General model)

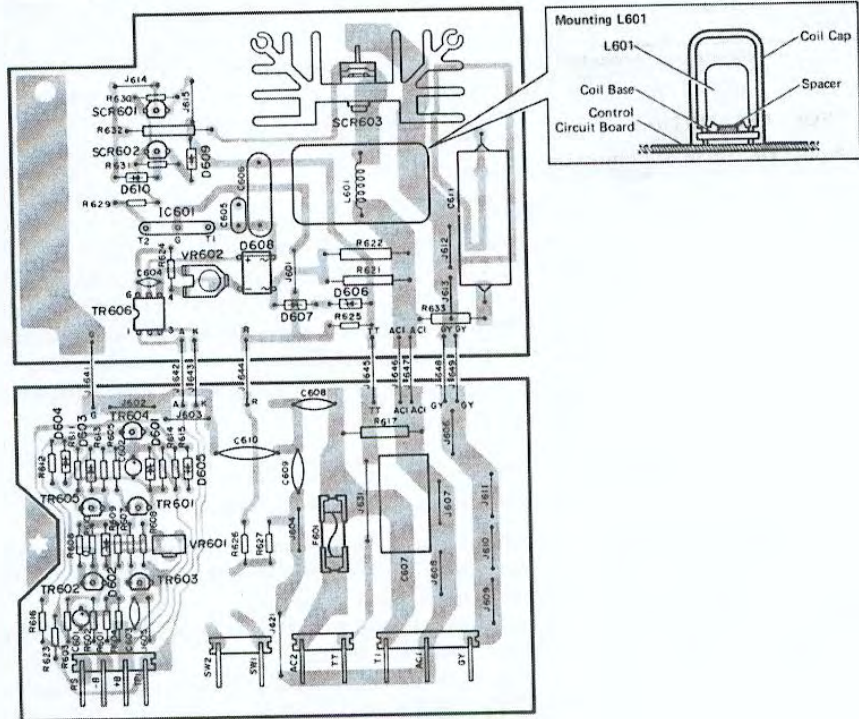
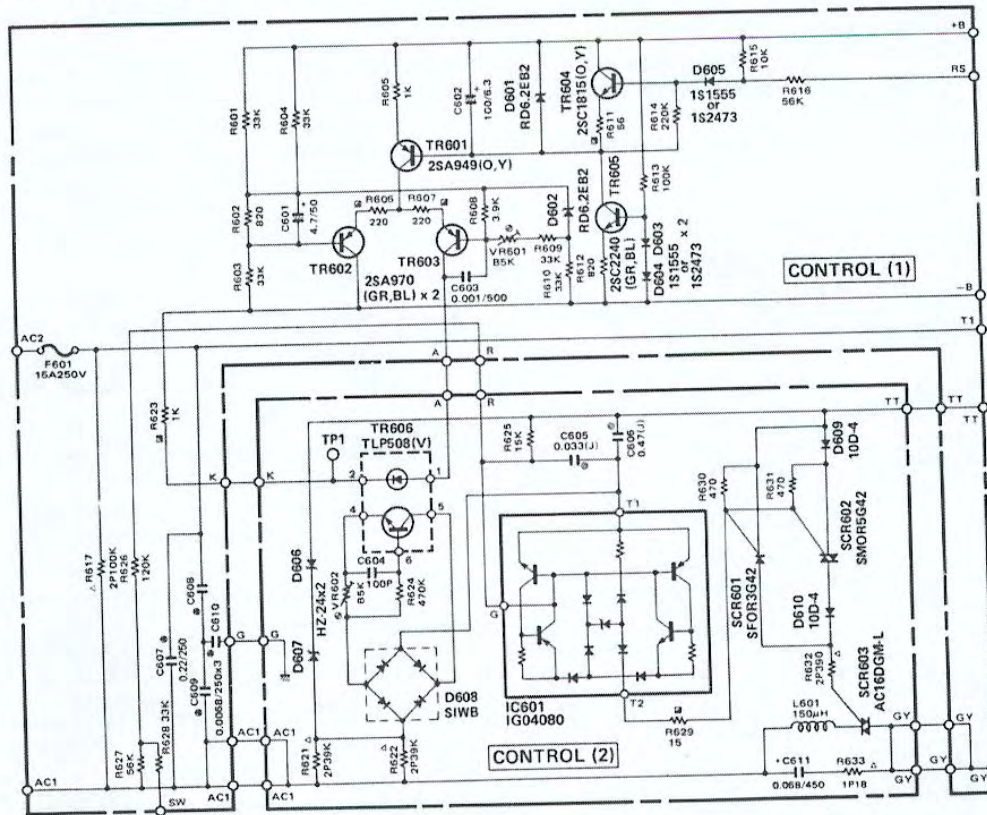

CONTROL C. BOARD / SCHEMATIC DIAGRAM (British, Australian and European models)

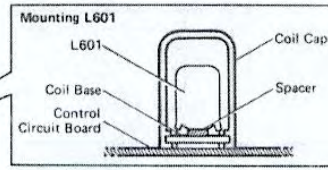
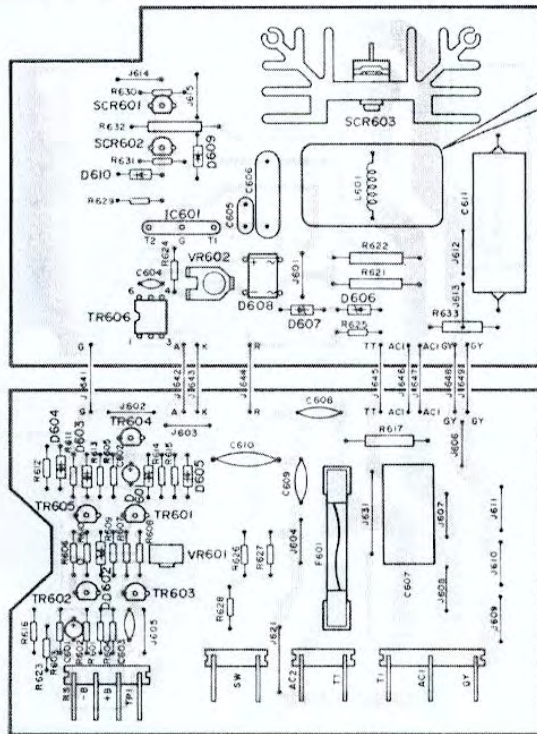
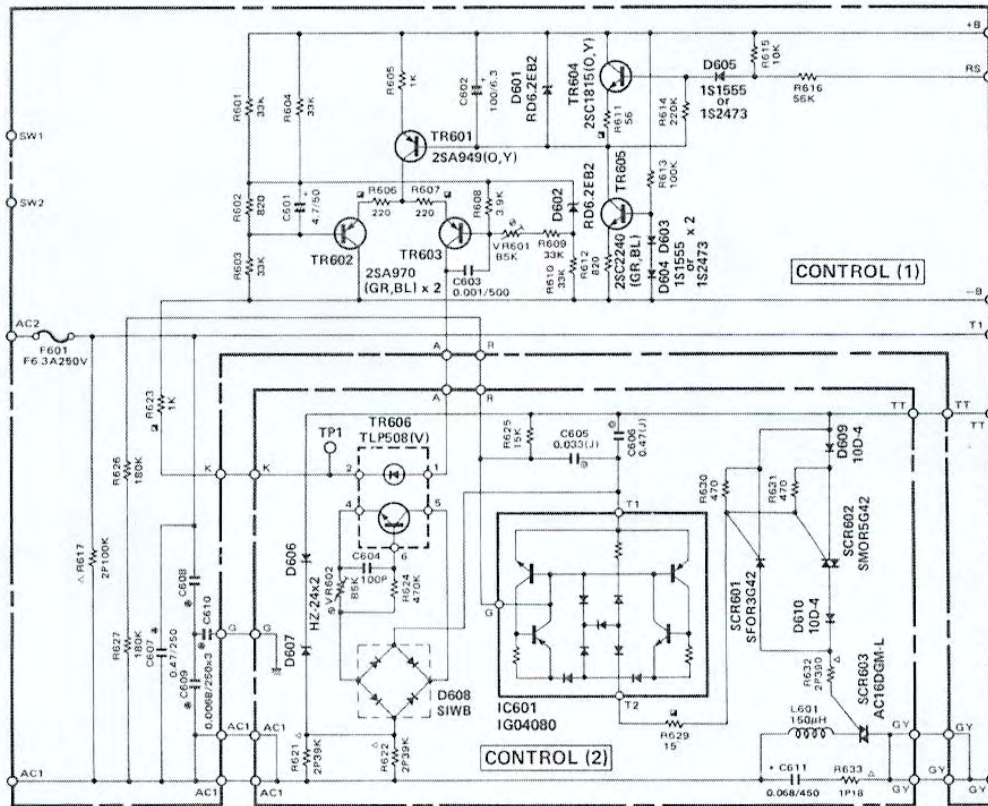

NOTE: (P), (D) models only

C602	47/6.3	UW917470
R606,607	180	HJ355180
R609	15k	HJ357150
R612	1k	HJ356100
TR606	4N35	iK000350

BLOCK DIAGRAM

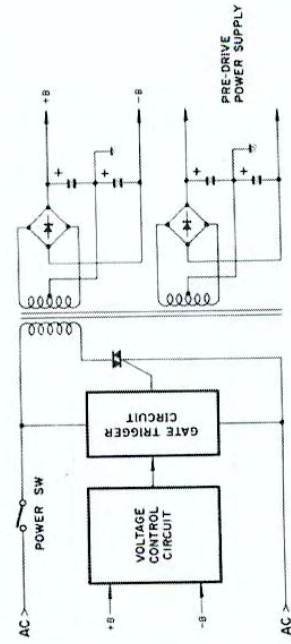
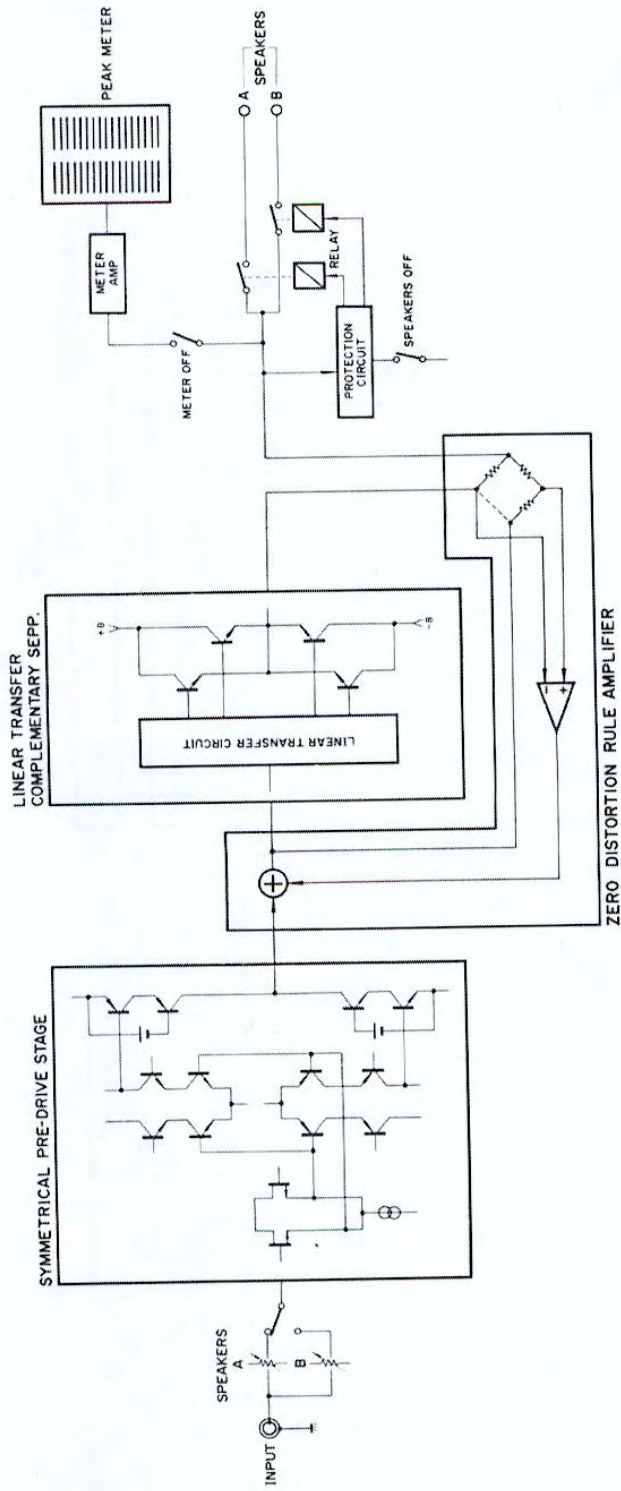

PARTS LIST

M-50 STEREO POWER AMPLIFIER

■ CONTENTS

EXPLODED VIEW	1
PARTS LIST (FRONT PANEL)	2
EXPLODED VIEW	3
PARTS LIST (REAR PANEL)	4
PARTS LIST (CIRCUIT BOARD)	6 ~ 12

U : U.S.A. model
C : Canadian model
A : Australian model
G : European model
B : British model
R : General model

SINCE 1887



YAMAHA

NIPPON GAKKI CO., LTD. HAMAMATSU, JAPAN

004453

EXPLODED VIEW (FRONT PANEL)

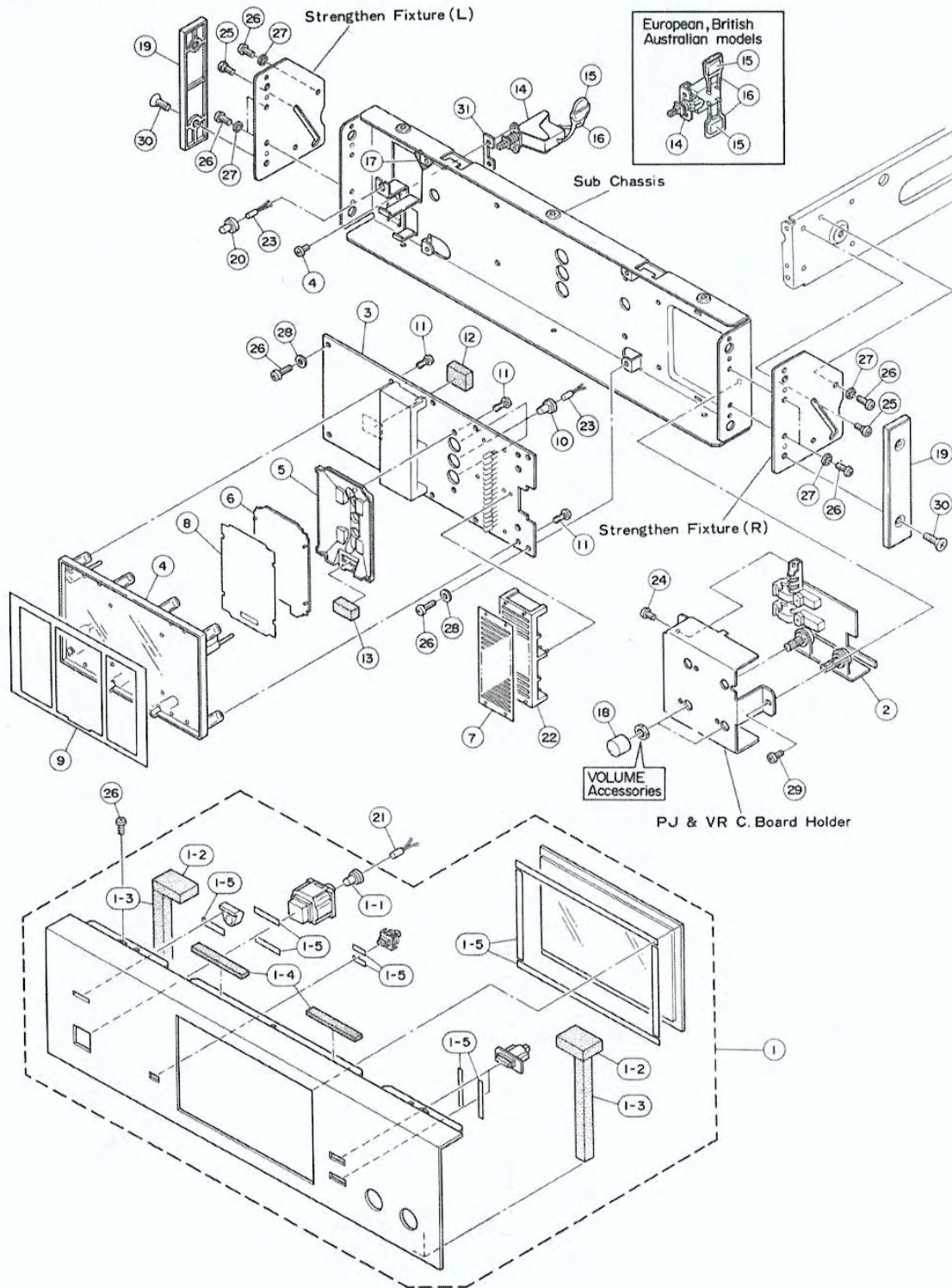

PARTS LIST

Ref. No.	Part No.	Description	部 品 名	Remarks	Common Model	Markets
* 1	NB:60:23:90	Panel Unit	パネルユニット			J
* "	NB:60:24:00	"	"			R,U,A,G,C,B
1-1	CB:60:50:70	Cap, Lamp	ランプキャップ		M-70	
1-2	CB:08:47:50	Damper	ダンパー			
* 1-3	CB:60:50:50	Shade Tape	シャコウテープ			
1-4	CB:60:50:60	Damper	ダンパー		M-70	
1-5	CB:07:41:90	Adhesive Tape	ダブルタックテープ			
* 2	NA:07:50:60	PJ & VR Circuit Board	P J & V R シート			J
* "	NA:07:91:80	"	"			R,U,C
* "	NA:07:96:70	"	"			A,G,B
* 3	NA:07:74:70	Meter Circuit Board	メーターシート			J
* "	NA:07:74:80	"	"			R,A,G,B
* "	NA:07:74:90	"	"			U,C
4	CB:60:34:20	Meter Housing	メーターハウジング		M-70	
5	CB:60:34:30	Reflector Lamp	ランプリフレクター		M-70	
6	CB:60:34:40	Diffusion Plate	拡散板		M-70	
7	CB:60:34:50	Diffusion Sheet	拡散シート		M-70	
* 8	CB:60:36:50	Scale Plate	メーター文字板			
9	CB:60:34:70	Cover, Meter	メーターカバー		M-70	
10	CB:60:44:10	Cap, Lamp	ランプキャップ		M-70	
11	CB:06:88:80	Plastic Rivet	プラスチックリベット			
12	CB:09:34:70	Spacer	スペーサー			
* 13	CB:60:73:30	Shade Damper	シャコウダンパー			
14	KA:80:26:20	Push Switch	SDZ1P	プッシュスイッチ	POWER	M-70 J
"	KA:80:25:50	"	SDZ1P-A	"	"	" R,U,C
"	KA:80:21:70	"	SDS3P	"	"	" A,G,B
15	Fi:16:41:00	Ceramic Cap	0.01 μ F 125V	セラコン		J
"	Fi:34:41:00	"	0.01 μ F	"		R,U,C
"	FR:16:41:00	Metalized Paper Cap	0.01 μ F 250V	M P コン		A,G,B
16	CB:07:21:90	Cover	コンデンサーカバー			"
"	CB:09:52:60	"	"			J,R,U,C
17	CB:08:01:00	Tape	粘着テープ			
18	BA:08:15:50	Level Knob	レベルツマミ		M-70	
19	CB:60:42:80	Side Plate	サイドプレート		M-70	
20	CB:60:50:80	Cap Lamp	ランプキャップ	PROTECTION	M-70	
21	JB:00:06:70	Lamp	14.5V 80mA	パイロットランプ	POWER	
22	CB:60:33:30	Reflector, LED		LEDリフレクター		M-70
23	JB:00:06:80	Lamp	14.5V 80mA	パイロットランプ		
24	ED:33:00:60	Bind Head Screw	M3x6 FCM3-B ℓ	バインド小ネジ		
25	EN:93:70:10	Bind Head Tapping Screw with Step	3x8 ZMC2-B ℓ	段付バインドタッピンネジ(3種)		
26	EN:33:00:10	Bind Head Tapping Screw	3x8 FCM3-B ℓ	バインドタッピンネジ(2種)		
27	EV:41:30:39	Toothed Lock Washer	M3 FCM3-B ℓ	内歯形歯付座金		
28	EV:20:33:00	Plain Washer	M3 FCM3-B ℓ	平座金		
29	EN:33:00:20	Bind Head Tapping Screw	3x6 FCM3-B ℓ	バインドタッピンネジ(2種)		
30	AA:60:82:20	Make Up Screw		化粧ネジ	M-70	
31	CB:60:29:20	Spacer, Switch		スイッチスペーサー		C
		Accessories Assembly		付属品 Ass'y		
	Mi:06:99:20	Cord		接続コード(ピンピン)		

* New Parts (新規部品)

PARTS LIST

Ref. No.	Part No.	Description	部 品 名	Remarks	Common Model	Markets
1	iA 09:68:00	Transistor	2SA968 (O,Y)	ト ラ ン ジ ス タ	TR133, 134	
"	iC 22:38:00	"	2SC2238 (O,Y)	"	TR131, 132	
2	iA 11:46:00	"	2SA1146 (O,Y)	"	TR137, 138 TR141, 142	
"	iC 27:06:00	"	2SC2706 (O,Y)	"	TR135, 136 TR139, 140	
*	3 BA 08:28:50	Heat Sink		放 熱 板		
4	CB 07:28:80	Isolation Bush		絶 縁 ブ ッ シ ュ		
5	iL 00:02:70	Mica Base		マイ カ ベ ース		
6	iL 00:04:60	"		"		
*	7 GA 64:80:00	Power Transformer		電 源 ト ラ ン ス		J
*	" GA 64:81:00	"		"		U
*	" GA 64:82:00	"		"		C
*	" GA 64:83:00	"		"		G
*	" GA 64:84:00	"		"		A, B
*	" GA 64:85:00	"		"		R
8	KA 40:07:40	Slide Switch		ス ラ イ ド ス イ ッ チ		"
9	LB 20:13:00	Fuse Holder		ヒ ュ ー ズ ホ ル ダ ー		"
10	AA 60:75:70	CS Holder		C S ホ ル ダ ー	M-70	
11	BA 08:10:90	Cover, Transformer		ト ラ ン ス カ バ ー	M-70	
12	CB 09:99:10	Rubber, Antivibration		防 振 ゴ ム	A-760	
13	CB 09:98:30	P.C. Support		P C サ ポ ー ト		
14	CB 60:42:70	Isolation Plate		絶 縁 板	M-70	
15	CB 60:50:90	Bush		リ ー ド ブ ッ シ ュ	M-70	
16	CB 60:51:00	Cover Packing		カ バ ー パ ッ キ ン グ	M-70	
17	CB 60:41:00	"		"	A-1060	J, R, A, G, B
"	CB 60:53:80	"		"		U, C
18	CB 08:01:00	Tape		粘 着 テ ー プ		
19	AA 60:96:20	Plate		ブ レ ー ト	A-1060	
20	CB 60:71:90	Damper Tape		ダンパーテープ	A-1060	
*	21 NA 07:75:60	Main Circuit Board		メ イン シ ー ト		J
"	NA 07:75:80	"		"		R, U, A, G, C, B
*	22 NA 07:76:60	Electrolytic Cap Circuit Board		ケ ミ コ ン シ ー ト		J
*	" NA 07:76:70	"		"		U, C
*	" NA 07:76:80	"		"		A, G, B
*	" NA 07:95:20	"		"		R
*	23 NA 07:77:40	Control Circuit Board		制 御 シ ー ト		J
"	NA 07:77:50	"		"		R
"	NA 07:77:60	"		"		U, C
"	NA 07:77:70	"		"		A, G, B
24	CB 80:68:50	Cord Stopper		コ ー ド ス ト ッ パ ー		J
"	CB 07:27:50	"		"		R, U, A, G, C, B
25	KB 00:13:00	Fuse	T7.0A 250V	ヒ ュ ー ズ		R
26	LB 20:18:10	AC Socket (Single)		A C ア ウ ト レ ッ ト		J, R, U
"	LB 20:20:70	"		"		C
*	27 MG 00:12:20	Power Cord	15A 125V 2m	電 源 コ ー ド		J
"	MG 00:07:80	"	6A 250V 2m	"		R
"	MG 00:13:60	"	13A 125V 2m	"		U, C
"	MG 00:09:10	"	6A 250V 2m	"		G
"	MG 00:09:20	"	7.5A 250V 2.5m	"		A
"	MG 00:10:00	"	6A 300/500V 2m	"		B
*	28 NA 07:78:70	Pre Drive Circuit Board		プ リ ド ラ イ ブ シ ー ト		J
"	NA 07:78:80	"		"		R, A, G, B
"	NA 07:78:90	"		"		U, C
*	29 AA 60:82:30	Rear Panel		リ ア パ ネ ル		J

* New Parts (新規部品)

Ref. No.	Part No.	Description	部 品 名	Remarks	Common Model	Markets
* 29	AA 60 82 40	Rear Panel	リ ア パ ネ ル			R
* "	AA 60 82 50	"	"			U,C
* "	AA 60 82 60	"	"			G
* "	AA 60 82 70	"	"			A,B
30	CB 09 26 80	P.C. Support	P C サ ポ ー ト			
31	CB 60 14 40	Switch Guard	V S ス ト ッ パ ー			R
32	AA 60 97 40	Metal Fitting, Protection	保 護 金 具			A,G,B
33	CB 09 04 40	Rubber, Antivibration	防 振 ゴ ム			
34	CB 06 88 80	Plastic Rivet	プ ラ ス チ ッ ク リ ベ ッ ト			
35	CB 09 12 90	P.C. Board Holder	基 板 ホ ル ダ ー			
36	CB 60 74 30	Cushion, Antivibration	防 振 ク ッ シ ョ ン			
37	AA 60 75 10	Top Cover	ト ッ プ カ バ ー		M-70	
38	AA 60 75 30	Bottom Cover	ボ ト ム カ バ ー		M-70	
39	CB 07 94 90	Leg	脚			
40	CB 60 73 40	Rubber, Antivibration	防 振 ゴ ム			
* 41	NA 07 50 60	PJ & VR Circuit Board	P J & V R シ ー ト			J
* "	NA 07 91 80	"	"			R,U,C
* "	NA 07 96 70	"	"			A,G,B
42	ED 33 01 20	Bind Head Screw	3x12 ZMC2-Bℓ	バ イ ン ド 小 ネ ジ		
43	EH 02 60 80	Cums Head Screw Sp Washer	M2.6x8 ZMC2-Y	セ ム ス ナ ベ 小 ネ ジ (ダ ブ ル セ ム ス)	(Sems Type)	
44	EV 30 33 00	Spring Washer	M3 FCM3-Bℓ	ス プ リ ン グ ワ ッ シ ャ ー		
45	EN 33 00 10	Bind Head Tapping Screw	3x8 FCM3-Bℓ	バ イ ン ド タ ッ ピ ン ネ ジ (2種)		
46	EZ 00 14 00	Ground Terminal Screw	3x13.5 MFMIII	ア ー ス 端 子 ネ ジ		
* 47	EV 20 84 00	Plain Washer	φ4	平 座 金		J
48	EV 20 33 00	"	M3 FCM3-Bℓ	"		
49	EN 33 00 20	Bind Head Tapping Screw	3x6 FCM3-Bℓ	バ イ ン ド タ ッ ピ ン ネ ジ (2種)		
* 50	EG 34 09 70	Pan Head Screw	M4x97 FCM3-Bℓ	ナ ベ 小 ネ ジ		
51	EV 20 34 00	Plain Washer	M4 FCM3-Bℓ	平 座 金		
52	EV 41 30 39	Toothed Lock Washer	M3 FCM3-Bℓ	内 歯 形 歯 付 座 金		
53	EV 90 13 60	Sems Plain Washer	φ3.6xφ10x10.8 FCM3-3g	セ ム ス 平 座 金		
54	ED 33 00 60	Bind Head Tapping Screw	M3x6 FCM3-Bℓ	バ イ ン ド 小 ネ ジ		R,A,G,B
55	EN 33 01 00	Bind Head Tapping Screw	3x16 ZMC2-Bℓ	バ イ ン ド タ ッ ピ ン ネ ジ (2種)		
56	AA 60 82 10	Make Up Screw	ZMC2-Bℓ	化 粧 ネ ジ	M-70	
57	AA 60 38 50	Screw		段 付 ネ ジ	A-760	
58	BA 07 95 30	Heat Sink		放 熱 板		
	CB 06 92 50	Binding Tie		イ ン シ ュ ロ ッ ク タイ		

◆ New Parts (新規部品)

PARTS LIST (CIRCUIT BOARD)

Ref. No.	Part No.	Description	部 品 名	Remarks	Common Model	Markets
※	NA 07 50 60	PJ & VR Circuit Board	P J & V R シート			J
※	NA 07 91 80	"	"			R,U,C
※	NA 07 96 70	"	"			A,G,B
※	C401,402	FT 55 24 70 Polypropylene Film Cap.	470pF 50V	ポリプロピレンフィルムコン		
※	R401,402	HJ 35 53 30 Carbon Resistor	330Ω RD25	カーボン抵抗		
※	VR401 VR402	HS 41 10 10 Variable Resistor	B50kΩ x 2	可変抵抗器		
※	SW401	KA 90 22 40 Push Switch with Cam	2 point 4 circuit	カム付プッシュスイッチ		
※	PJ401	LB 20 19 80 Pin Jack with Edge	2P L Type	2Pピンジャックエッジ付		
※	NA 07 74 70	Meter Circuit Board	メーターシート			J
※	NA 07 74 80	"	"			R,A,G,B
※	NA 07 74 90	"	"			U,C
	C501,502	UW 86 62 20 Electrolytic Cap.	2.2μF 50V	ケミコン		
	C503	UW 96 54 70 "	0.47μF 50V	"		
	C504,505	UA 25 41 50 Mylar Cap.	0.015μF 50V	マイラーコン		
	C513	UW 86 61 00 Electrolytic Cap.	1μF 50V	ケミコン		
	R501,502	HJ 35 81 00 Carbon Resistor	100kΩ RD25	カーボン抵抗		
	R503,504	HJ 35 81 50 "	150kΩ "	"		
※	R505,506	HK 35 73 00 "	30kΩ "	"		J
	"	HJ 35 72 70 "	27kΩ "	"		R,U,A,G,C,B
	R507	HL 32 62 20 Metal Oxide Film Resistor	2.2kΩ 2P	酸化金抵抗		
	R509,510	HJ 35 61 20 Carbon Resistor	1.2kΩ RD25	カーボン抵抗		
	R511,512	HJ 35 71 00 "	10kΩ "	"		
	R513	HJ 35 62 70 "	2.7kΩ "	"		
	R515,516	HJ 35 51 00 "	100Ω "	"		
	R517~538	HJ 35 61 00 "	1kΩ "	"		
	R539,540	HJ 35 71 00 "	10kΩ "	"		
	R541,542	HJ 35 51 00 "	100Ω "	"		
	R543~563	HJ 35 61 00 "	1kΩ "	"		
	R565,566	HJ 35 71 00 "	10kΩ "	"		
	R567	HJ 35 76 80 "	68kΩ "	"		
	R568	HJ 35 72 70 "	27kΩ "	"		
	R569	HJ 35 63 30 "	3.3kΩ "	"		
	VR501, VR502	HT 37 00 40 Semi Variable	B500Ω	半固定抵抗	Inter-changeable	
	"	HT 77 00 20 "	"	"		
	TR501	iC 18 15 70 Transistor	2SC1815 (O,Y)	トランジスタ		
	D501	iF 00 14 70 Zener Diode	RD6.2EB2	ツェナーダイオード		
※	D503~542	iF 00 32 20 LED (Orange)	SLR-34DW	L E D	M-70	
	D546	iH 00 07 20 Diode	W03B	ダイオード		
	IC501	iG 03 07 00 IC	TA7318P	i C		
	IC503~ IC506	iG 03 06 00 "	TA7612AP	"		
※	SW501	KA 90 22 30 Push Switch with Cam	2 circuit	カム付プッシュスイッチ		
	LA 00 21 10	Wrapping Terminal	P=5 2P (i Type)	i型ラッピング端子板		
	LA 00 21 20	"	P=5 3P (i Type)	"		
※	CB 60 33 30	LED Reflector		LEDリフレクター		
	CB 07 41 90	Adhesive Tape		ダブルタックテープ		
※	NA 07 75 60	Main Circuit Board	メインシート			J
※	NA 07 75 80	"	"			R,U,A,G,C,B
	C101,102	UA 25 41 00 Mylar Cap.	0.01μF 50V	マイラーコン		R,U,A,G,C,B
※	"	FC 34 51 00 "	0.1μF 50V	"		J
	C103,104	FG 41 31 00 Ceramic Cap.	0.001μF 50V	セラコン		R,U,A,G,C,B
	"	UA 25 31 00 Polypropylene Film Cap.	0.001μF 50V	ポリプロピレンフィルムコン		J

* New Parts (新規部品)

Ref. No.	Part No.	Description	部 品 名	Remarks	Common Model	Markets
C105~108	UM:02:81:00	Electrolytic Cap.	100 μ F 6.3V	ケ ミ コ ン		J
"	UW:81:81:00	"	100 μ F 6.3V	"		R,U,A,G,C,B
* C109~112	UM:05:64:70	"	4.7 μ F 25V	"		J
"	UW:84:71:00	"	10 μ F 25V	"		R,U,A,G,C,B
C115~118	FG:41:22:20	Ceramic Cap.	220pF 50V	セ ラ コ ン		R,U,A,G,C,B
"	FT:51:22:20	Polypropylene Film Cap.	220pF 50V	ポリプロピレンフィルムコン		J
C119~122	FG:44:42:20	Ceramic Cap.	0.022 μ F 50V	セ ラ コ ン		R,U,A,G,C,B
"	UA:25:42:20	Mylar Cap.	0.022 μ F 50V	マイラーコン		J
C123,124	UA:25:44:70	"	0.047 μ F 50V	"		
C125~128	UW:88:72:20	Electrolytic Cap.	22 μ F 80V	ケ ミ コ ン		R,U,A,G,C,B
"	FV:69:72:20	"	22 μ F 100V	プラスチックケミコン		J
* C129~132	FC:02:41:00	Mylar Cap.	0.01 μ F 100V	マイラーコン		
C133,134	FC:25:51:00	Metellized Mylar Cap.	0.1 μ F 250V	M M コ ン		
C135~138	UA:25:51:00	Mylar Cap.	0.1 μ F 50V	マイラーコン		
C139~142	UA:25:42:20	"	0.022 μ F 50V	"		
* C143	UM:04:73:30	Electrolytic Cap.	33 μ F 16V	ケ ミ コ ン		J
"	FM:50:73:30	"	33 μ F 16V	Z コ ン		R,U,A,G,C,B
C144	FG:44:42:20	Ceramic Cap.	0.022 μ F 50V	セ ラ コ ン		
C145	UW:81:81:00	Electrolytic Cap.	100 μ F 6.3V	ケ ミ コ ン		
L101,102	GD:90:03:70	Coil	1.5 μ H	空 芯 コ イ ル		
R101,102	HJ:35:46:80	Carbon Resistor	68 Ω RD25	カ ー ボ ン 抵 抗		
R103~106	HJ:35:44:70	"	47 Ω "	"		
R107~114	HJ:35:54:70	"	470 Ω "	"		
R115~122	HJ:35:58:20	"	820 Ω "	"		
R123~130	HJ:35:48:20	"	82 Ω "	"		
R131~134	HJ:35:62:20	"	2.2k Ω "	"		
R135~142	HJ:35:73:90	"	39k Ω "	"		
R143~146	HJ:35:63:30	"	3.3k Ω "	"		
R147,148	HJ:35:66:80	"	6.8k Ω "	"		
R149,150	HJ:35:65:60	"	5.6k Ω "	"		
R151,152	HJ:35:62:20	"	2.2k Ω "	"		
R153~156	HJ:35:62:70	"	2.7k Ω "	"		
R157,158	HJ:35:81:00	"	100k Ω "	"		
R159~162	HJ:35:81:20	"	120k Ω "	"		
R163~166	HJ:35:64:70	"	4.7k Ω "	"		
R167~170	HJ:35:51:50	"	150 Ω "	"		
R171~174	HV:35:42:20	Flame Proof Carbon Resistor	22 Ω RDF25SF	不 燃 化 カ ー ボ ン 抵 抗		
R175~178	HV:35:61:20	"	1.2k Ω "	"		
* R179,180	HV:35:63:90	"	3.9k Ω "	"		
R181~184	HV:35:34:70	"	4.7 Ω "	"		
R185,186	HV:35:48:20	"	82 Ω "	"		
R187~190	HV:35:34:70	"	4.7 Ω "	"		
R191~194	HV:35:45:60	"	56 Ω "	"		
R195~202	HZ:00:21:60	Metal Plate Resistor	0.33 Ω 3P	金 属 板 抵 抗		
R203~206	HV:35:34:70	Flame Proof Carbon Resistor	4.7 Ω RDF25SF	不 燃 化 カ ー ボ ン 抵 抗		
R207,208	HV:35:41:00	"	10 Ω "	"		
* R209,210	HZ:00:22:60	Metal Plate Resistor	0.1 Ω 5P	金 属 板 抵 抗		
R211,212	HL:81:41:00	Metal Oxide Film Resistor	10 Ω 1P	酸 金 抵 抗		
R213,214	HZ:00:21:50	Cement Molded Resistor	10 Ω 5P	セ メ ン ト 抵 抗		
R215,216	HJ:35:34:70	Carbon Resistor	4.7 Ω RD25	カ ー ボ ン 抵 抗		
R217,218	HJ:35:41:00	"	10 Ω "	"		
R219	HJ:35:65:60	"	5.6k Ω "	"		
R220	HJ:35:73:90	"	39k Ω "	"		

◆ New Parts (新規部品)

Ref. No.	Part No.	Description	部 品 名	Remarks	Common Model	Markets
R221	HJ 35:63:90	Carbon Resistor	3.9kΩ RD25	カーボン抵抗		
R222	HJ 35:81:50	"	150kΩ "	"		
R223	HJ 35:41:00	"	10Ω "	"		
R224	HJ 35:73:90	"	39kΩ "	"		
R225,226	HJ 35:71:20	"	12kΩ "	"		
R227	HJ 35:75:60	"	56kΩ "	"		
R228,229	HJ 35:78:20	"	82kΩ "	"		
* R230	HL 71:53:30	Metal Oxide Film Resistor	330Ω 1P	酸金抵抗		
R232	HJ 35:72:20	Carbon Resistor	22kΩ RD25	カーボン抵抗		
R233~248	HJ 35:73:90	"	39kΩ "	"		
R249~252	HJ 35:51:00	"	100Ω "	"		
R253,254	HJ 35:61:00	"	1kΩ "	"		
R255~258	HJ 35:78:20	"	82kΩ "	"		
* VR101~VR104	HY 00:09:90	Metal Gazed Variable Resistor	B500Ω	メタルグレイズボリューム		
TR101,102	iC 27:05:00	Transistor	2SC2705(O,Y)	トランジスタ		
TR103,104	iA 11:45:00	"	2SA1145(O,Y)	"		
TR105~TR108	iA 10:15:70	"	2SA1015(O,Y)	"		
TR109~TR116	iC 18:15:70	"	2SC1815(O,Y)	"		
TR117~TR120	iA 10:15:70	"	2SA1015(O,Y)	"		
TR121,122	iC 22:40:00	"	2SC2240(GR,BL)	"		
TR123,124	iC 15:09:30	"	2SC1509(O,R)	"		
TR125,126	iA 07:77:30	"	2SA777(O,R)	"		
TR127,128	iC 27:05:00	"	2SC2705(O,Y)	"		
TR129,130	iA 11:45:00	"	2SA1145(O,Y)	"		
TR143	iA 06:73:10	"	2SA673(C,D)	"		
TR144	iB 05:60:00	"	2SB560	"		
TR145~TR147	iC 18:15:70	"	2SC1815(O,Y)	"		
TR148	iA 10:15:70	"	2SA1015(O,Y)	"		
D101,102	iF 00:07:90	Varistor	MV12	バリスタ		
D103~106	iF 00:14:70	Zener Diode	RD6.2EB2	ツェナーダイオード		
D107~114	iF 00:14:00	Diode	1SS82	ダイオード		
D115~118	iF 00:00:40	"	1S1555	"	Inter-changeable	
"	iF 00:06:70	"	1S2473	"		
D119~122	iF 00:14:00	"	1SS82	"		
D123	iF 00:00:40	"	1S1555	"	Inter-changeable	
"	iF 00:06:70	"	1S2473	"		
D124,125	iF 00:16:20	"	1S2076A	"		
D126	iF 00:14:70	Zener Diode	RD6.2EB2	ツェナーダイオード		
D127	iF 00:00:40	Diode	1S1555	ダイオード	Inter-changeable	
"	iF 00:06:70	"	1S2473	"		
D128	iF 00:14:70	Zener Diode	RD6.2EB2	ツェナーダイオード		
D129,130	iF 00:00:40	Diode	1S1555	ダイオード	Inter-changeable	
"	iF 00:06:70	"	1S2473	"		
* RY101,102	KC 00:12:20	Relay	MSJ12D2-OM	リレー		
	LA 00:21:10	Wrapping Terminal	P=5 2P (i Type)	i型ラッピング端子板		
	LA 00:21:20	"	P=5 3P (i Type)	"		
	LA 00:35:10	Lock Terminal	4P	4Pワンロックターミナル		
	LA 00:35:20	"	"	"		
	LB 40:05:70	2.5 Pitch Base Pin	TEB4P-SHF	2.5ピッチベースピン		
	LA 00:20:30	Wrapping Terminal	P=5 4P (i Type)	i型ラッピング端子板		
	LA 00:41:20	Test Point Pin		テストポイントピン		
	BB 06:52:50	Pusher, Transistor		T R プッシャー		
	BB 06:83:70	Plate, Ground		アース金具		

◆ New Parts (新規部品)

Ref. No.	Part No.	Description	部 品 名	Remarks	Common Model	Markets
	BB 06:62:90	Washer	ワ ッ シ ャ ー			
*	NA 07:76:80	Electrolytic Cap. Circuit Board	ケ ミ コ ン シ ー ト			J
*	NA 07:76:70	"	"			U,C
*	NA 07:76:80	"	"			A,G,B
*	NA 07:95:20	"	"			R
*	C801 FZ 00:27:80	Electrolytic Cap.	4700 μ F 16V	ケ ミ コ ン		
	C802 UW 93:71:00	"	10 μ F 16V	"		
	C803 UW 86:61:00	"	1 μ F 50V	"		
	C804 UW 86:71:00	"	10 μ F 50V	"		
*	C805~808 FZ 00:28:10	"	10000 μ F 63V	"		
*	C809,810 FZ 00:27:90	"	1000 μ F 80V	"		
	R801 HJ 35:45:60	Carbon Resistor	56 Ω RD25	カ ー ボ ン 抵 抗		
	R802,803 HJ 35:71:80	"	18k Ω "	"		
	R804 HJ 35:61:80	"	1.8k Ω "	"		
	R805 HJ 35:73:30	"	33k Ω "	"		
	R806 HJ 35:61:00	"	1k Ω "	"		
*	R807 HL 72:36:80	Metal Oxide Film Resistor	6.8 Ω 2P	酸 金 抵 抗		
*	R808,809 HL 82:71:80	"	18k Ω 2P	"		J,R
*	" HL 82:65:60	"	5.6k Ω 2P	"		U,A,G,C,B
*	R810,811 HL 81:71:50	"	15k Ω 1P	"		
	TR801 iC 22:35:00	Transistor	2SC2235(O,Y)	ト ラ ン ジ ス タ		
	TR802 iC 19:83:00	"	2SC1983	"		
*	D801 iH 00:11:70	Diode Bridge	D4BB20	ダ イ オ ー ド ブ リ ッ ジ		
*	D802 iH 00:11:20	"	S2VB20	"		
*	D803 iH 00:02:80	Diode	1D2C1	ダ イ オ ー ド	Inter-changeable	
*	" iH 00:11:80	"	S2VC10	"		
	D804 iF 00:02:00	Zener Diode	WZ-120	ツ ェ ナ ー ダ イ オ ー ド		
	D805~808 iH 00:07:10	Diode	W06C	ダ イ オ ー ド		
	F801,802 KB 00:04:20	Fuse	T2.5A 250V	ヒ ュ ー ズ		J,R
	" KB 00:07:50	"	T2.0A 250V	"		A,G,B
	" KB 00:11:10	"	2.5A 250V	"		U,C
	LA 00:23:50	Wrapping Terminal	P=5 2P (L Type)	L型ラッピング端子板		
	LA 00:23:60	"	P=5 3P (L Type)	"		
	LA 00:23:90	"	P=7.5 2P (L Type)	"		
	LA 00:24:20	"	P=10 3P (L Type)	"		
	LA 00:26:10	"	P=5 2P (L Type)	"		
*	LA 00:26:20	"	P=5 3P (L Type)	"		
	LB 20:18:80	Fuse Holder Pin	PC-FH1	ヒ ュ ー ズ ホ ル ダ ー ピ ン		
*	NA 07:78:70	Pre Drive Circuit Board	プ リ ド ラ イ ブ シ ー ト			J
*	NA 07:78:80	"	"			R,A,G,B
*	NA 07:78:90	"	"			U,C
	C901,902 FT 55:21:00	Polypropylene Film Cap.	100pF 50V	ポ リ プ ロ ピ レ ン フ ィ ル ム コ ン		R,U,A,G,C,B
	C903,904 FH 61:04:00	Ceramic Cap.	4pF 500V	セ ラ コ ン		J
	" FU 35:04:00	Mica Cap.	4pF 500V	マ イ カ コ ン		R,U,A,G,C,B
	C905,906 FG 41:22:20	Ceramic Cap.	220pF 50V	セ ラ コ ン		R,U,A,G,C,B
	" FT 51:22:20	Polypropylene Film Cap.	220pF 50V	ポ リ プ ロ ピ レ ン フ ィ ル ム コ ン		J
	C907,908 UA 25:31:00	Mylar Cap	0.001 μ F 50V	マ イ ラ ー コ ン		J
	" FG 41:31:00	Ceramic Cap.	0.001 μ F 50V	セ ラ コ ン		R,U,A,G,C,B
	C909~912 FG 41:22:20	"	22pF 50V	"		R,U,A,G,C,B
	" FU 35:12:20	Mica Cap.	22pF 500V	マ イ カ コ ン		J
	C913~916 FH 61:08:00	Ceramic Cap.	8pF 500V	セ ラ コ ン		R,U,A,G,C,B
	" FU 35:08:00	Mica Cap.	8pF 500V	マ イ カ コ ン		J

→ New Parts (新規部品)

Ref. No.	Part No.	Description	部 品 名	Remarks	Common Model	Markets
* C917~920	FC 34 44 70	Mylar Cap.	0.047 μ F 50V	マイラーコン		J
"	UA 25 44 70	"	0.047 μ F 50V	"		R,U,A,G,C,B
C921,922	FH 61 16 80	Ceramic Cap.	68pF 500V	セラコン		R,A,G,B
"	FH 61 21 00	"	100pF 500V	"		U,C
"	FU 35 21 00	Mica Cap.	100pF 500V	マイカコン		J
C923~926	UW 88 72 20	Electrolytic Cap.	22 μ F 80V	ケミコン		R,U,A,G,C,B
"	FV 69 72 20	"	22 μ F 100V	ブラステックケミコン		J
* C927,928	UW 91 74 70	"	47 μ F 6.3V	ケミコン		R,U,A,G,C,B
* "	UM 07 61 00	"	1 μ F 50V	"		J
C929,930	FH 61 13 30	Ceramic Cap.	33pF 500V	セラコン		R,A,G,B
R901,902	HJ 35 83 30	Carbon Resistor	330k Ω RD25	カーボン抵抗		
R903,904	HJ 35 61 00	"	1k Ω "	"		
R905,906	HJ 35 56 80	"	680 Ω "	"		
R907,908	HJ 35 42 20	"	22 Ω "	"		
R909,910	HJ 35 48 20	"	82 Ω "	"		
R911~914	HJ 35 63 30	"	3.3k Ω "	"		
R915,916	HJ 35 53 30	"	330 Ω "	"		
R917~920	HU 07 71 80	Metal Film Resistor	18k Ω RE35	金属被膜抵抗		
R921,922	HU 07 58 20	"	820 Ω "	"		J
R923,924	HJ 35 53 30	Carbon Resistor	330 Ω RD25	カーボン抵抗		R,U,A,G,C,B
"	HU 07 55 60	Metal Film Resistor	560 Ω RE35	金属被膜抵抗		J
R925,926	HJ 35 83 30	Carbon Resistor	330k Ω RD25	カーボン抵抗		
R927~930	HJ 35 63 30	"	3.3k Ω "	"		
R931~934	HJ 35 62 20	"	2.2k Ω "	"		
R935~938	HJ 35 56 80	"	680 Ω "	"		
R939~946	HJ 35 42 20	"	22 Ω "	"		
R947,948	HJ 35 51 50	"	150 Ω "	"		
R949,950	HJ 35 81 50	"	150k Ω "	"		
R951~954	HJ 35 64 70	"	4.7k Ω "	"		
R955~958	HJ 35 62 20	"	2.2k Ω "	"		
R959~962	HJ 35 51 20	"	120 Ω "	"		
R963~966	HV 35 52 20	Flame Proof Carbon Resistor	220 Ω RDF25SF	不燃化カーボン抵抗		
* VR901,902	HT 18 03 70	Metal Gazed Variable Resistor	B100 Ω	メタルグレイズボリューム		
TR901,902	iE 10 19 10	Dual FET	μ PA68H (L,H)	デュアルFET		
TR903,904	iC 27 05 00	Transistor	2SC2705(O,Y)	トランジスタ		
TR905,906	iA 11 45 00	"	2SA1145(O,Y)	"		
TR907,908	iC 22 40 00	"	2SC2240(GR,BL)	"		
TR909,910	iA 09 70 00	"	2SA970(GR,BL)	"		
TR911,912	iZ 00 01 20	Dual Transistor	μ PA74V	デュアルトランジスタ		
TR913,914	iZ 00 01 30	"	μ PA75V	"		
TR915,916	iA 09 99 10	Transistor	2SA999(E,F)	トランジスタ		
"	iA 10 15 70	"	2SA1015(O,Y)	"	Inter-changeable	
TR917,918	iC 23 20 10	"	2SC2320(E,F)	"	Inter-changeable	
"	iC 18 15 70	"	2SC1815(O,Y)	"		
TR919,920	iA 11 45 00	"	2SA1145(O,Y)	"		
TR921,922	iC 27 05 00	"	2SC2705(O,Y)	"		
TR923,924	iA 09 70 00	"	2SA970(GR,BL)	"		
TR925,926	iC 22 40 00	"	2SC2240(GR,BL)	"		
D901~908	iF 00 14 70	Zener Diode	RD6.2EB2	ツェナーダイオード		
D909~912	iF 00 00 40	Diode	1S1555	ダイオード		
"	iF 00 06 70	"	1S2473	"	Inter-changeable	
D913~916	iF 00 08 30	Zener Diode	RD4.7E	ツェナーダイオード		
	LA 00 23 60	Wrapping Terminal	P=5 3P (L Type)	L型ラッピング端子板		

◆ New Parts (新規部品)

Ref. No.	Part No.	Description	部 品 名	Remarks	Common Model	Markets
	LA 00:23:80	Wrapping Terminal	P=5 5P (L Type)	L 型ラッピング端子板		
	LB 30:07:30	2.5 Pitch Base Pin	TEB3P-SHF	2.5ピッチベースピン		
*	NA 07:77:40	Control Circuit Board		制 御 シ ー ト		J
*	NA 07:77:60	"		"		U,C
*	NA 07:77:50	"		"		R
*	NA 07:77:70	"		"		A,G,B
C601	UW 86:62:20	Electrolytic Cap.	2.2 μ F 50V	ケ ミ コ ン		J,U,C
"	UW 86:64:70	"	4.7 μ F 50V	"		R,A,G,B
C602	UW 91:81:00	"	100 μ F 6.3V	"		
C603	FH 21:31:00	Ceramic Cap.	0.001 μ F 500V	セ ラ コ ン		
C604	FG 41:21:00	"	100pF 50V	"		
C605	UA 25:43:30	Mylar Cap.	0.033 μ F 50V	マ イ ラ ー コ ン		
C606	FA 45:54:70	"	0.47 μ F 50V	"		
C607	FQ 02:52:20	Oil Cap.	0.22 μ F 630V	オ イ ル コ ン		J
"	FC 24:52:20	Metalized Mylar Cap.	0.22 μ F 125V	M M コ ン		U,C
"	FR 15:52:20	Metalized Paper Cap.	0.22 μ F 250V	M P コ ン		R
"	FR 15:54:70	"	0.47 μ F 250V	"		A,G,B
C608,609	Fi 34:33:30	Ceramic Cap.	0.0033 μ F 125V	セ ラ コ ン		J,U,C
C608-610	FR 16:36:80	Metalized Paper Cap.	0.0068 μ F 250V	M P コ ン		R,A,G,B
C611	FQ 02:51:00	Oil Cap.	0.1 μ F 630V	オ イ ル コ ン		J
"	FC 24:51:00	Metalized Mylar Cap.	0.1 μ F 630V	M M コ ン		U,C
"	FQ 09:46:80	Oil Cap.	0.068 μ F 450V	オ イ ル コ ン		R,A,G,B
L601	GD 90:04:20	Coil	150 μ H	雑 防 コ イ ル		
R601	HJ 35:73:30	Carbon Resistor	33k Ω RD25	カ ー ボ ン 抵 抗		
R602	HJ 35:58:20	"	820 Ω "	"		
R603,604	HJ 35:73:30	"	33k Ω "	"		
R605	HJ 35:61:00	"	1k Ω "	"		
R606,607	HV 35:51:20	Flame Proof Carbon Resistor	120 Ω RDF25SF	不 燃 化 カ ー ボ ン 抵 抗		J,U,C
"	HV 35:52:20	"	220 Ω "	"		R,A,G,B
R608	HJ 35:63:90	Carbon Resistor	820 Ω RD25	カ ー ボ ン 抵 抗		
R609	HJ 35:71:50	"	15k Ω "	"		J
"	HJ 35:71:80	"	18k Ω "	"		U,C
"	HJ 35:73:30	"	33k Ω "	"		R,A,G,B
R610	HJ 35:73:30	"	33k Ω "	"		
R611	HV 35:45:60	Flame Proof Carbon Resistor	56 Ω RDF25SF	不 燃 化 カ ー ボ ン 抵 抗		
R612	HJ 35:58:20	Carbon Resistor	820 Ω RD25	カ ー ボ ン 抵 抗		
R613	HJ 35:81:00	"	100k Ω "	"		
R614	HJ 35:82:20	"	220k Ω "	"		
R615	HJ 35:71:00	"	10k Ω "	"		
R616	HJ 35:75:60	"	56k Ω "	"		
R617	HJ 35:81:50	"	150k Ω "	"		J
*	HL 72:81:00	Metal Oxide Film Resistor	100k Ω 2P	酸 金 抵 抗		R,U,A,G,C,B
*	R621	HL 72:71:00	10k Ω 2P	"		J
"	HL 62:71:20	"	12k Ω 2P	"		U,C
"	HL 72:73:90	"	39k Ω 2P	"		R,A,G,B
R622	HL 72:73:90	"	39k Ω 2P	"		R,A,G,B
R623	HV 35:61:00	Flame Proof Carbon Resistor	1k Ω RDF25SF	不 燃 化 カ ー ボ ン 抵 抗		
R624	HJ 35:84:70	Carbon Resistor	470k Ω RD25	カ ー ボ ン 抵 抗		
R625	HJ 35:71:50	"	15k Ω "	"		
R626	HJ 35:81:20	"	120k Ω "	"		R,U,C
"	HJ 35:81:80	"	180k Ω "	"		A,G,B
R627	HJ 35:71:00	"	10k Ω "	"		J

⊕ New Parts (新規部品)

Ref. No.	Part No.	Description	部 品 名	Remarks	Common Model	Markets
R627	HJ 35 75 80	Carbon Resistor	56k Ω RD25	カーボン抵抗		R,U,C
"	HJ 35 81 80	"	180k Ω "	"		A,G,B
R628	HJ 35 73 30	"	33k Ω "	"		R
R629	HV 35 41 50	Flame Proof Carbon Resistor	15 Ω RDF25SF	不燃化カーボン抵抗		
R630,631	HJ 35 54 70	Carbon Resistor	470 Ω RD25	カーボン抵抗		
* R632	HL 72 53 90	Metal Oxide Film Resistor	390 Ω 2P	酸金抵抗		
R633	HL 31 41 80	"	18 Ω 1P	"		
VR601	HT 18 02 10	Semi Variable Resistor	B5k Ω	半固定抵抗		
* VR602	HY 00 10 30	Metal Gazed Variable Resistor	"	メタルグレースホリウム		
TR601	iA 09 49 00	Transistor	2SA949(O,Y)	トランジスタ		
TR602,603	iA 09 70 00	"	2SA970(GR,BL)	"		
TR604	iC 18 15 70	"	2SC1815(O,Y)	"		
TR605	iC 22 40 00	"	2SC2240(GR,BL)	"		
TR606	iK 00 03 00	Photo Coupler	TLP508 (V)	フォトカプラ		
D601,602	iF 00 14 70	Zener Diode	RD6.2EB2	ツェナーダイオード		
D603~605	iF 00 00 40	Diode	1S1555	ダイオード	Inter-changeable	
"	iF 00 06 70	"	1S2473	"		
D606,607	iF 00 19 40	Zener Diode	HZ-24	ツェナーダイオード		
D608	iH 00 08 80	Diode Bridge	S1WB	ダイオードブリッジ		
D609,610	iF 00 14 00	Diode	1S582	ダイオード		J
"	iH 00 00 60	"	10D-4	"		R,U,A,G,C,B
D611,612	iF 00 14 00	"	1S582	"		J
IC601	iG 04 08 00	IC	iG04080	トリガーIC	Trigger	
* SCR601	iH 00 11 50	Thyristor	0.3A SFOR3G42	サイリスタ		
SCR602	iH 00 09 00	Triac	0.5A SMOR5G42	トライアック		
SCR603	iH 00 10 50	"	16A AC16DGM-L	"		
F601	KB 00 12 70	Fuse	T15A 250V	ヒューズ		J
"	KB 00 15 40	"	12A 250V	"		U,C
"	KB 00 13 80	"	15A 250V	"		R
* " " " "	KB 00 22 40	"	F6.3A 250V	"		A,G,B
LA 00 23 70	Wrapping Terminal	P=5 4P(L Type)	L型ラッピング端子板			
LA 00 24 10	"	P=10 2P(L Type)	"			
LA 00 24 20	"	P=10 3P(L Type)	"			
LB 20 09 00	Fuse Holder Pin	YSH402P PC	ヒューズホルダーピン			J,R,U,C
LB 20 10 60	"	YSH403T	"			A,G,B
BA 07 95 30	Heat Sink		放熱板	A-760		
BB 06 62 90	Washer		ワッシャー			
CB 07 28 80	Isolation Bush		絶縁ブッシュ			
CB 60 38 40	Coil Cap.		コイルキャップ	A-1060		
CB 60 40 80	Coil Base		コイルベース	"		
iL 00 02 70	Mica Base	AC-229	マイカベース			
EA 02 61 00	Pan Head Screw	M2.6x10 ZMC2-Y	ナベ小ネジ			
Ei 03 00 80	Bind Head Tapping Screw	3x8 ZMC2-Y	バインドタッピングネジ(2種)			
CB 60 52 10	Spacer		スペーサー	A-1060		
EV 20 02 60	Plain Washer	M2.6 ZMC2-Y	平座金			
EV 30 02 60	Spring Washer	M2.6 ZMC2-Y	バネ座金			

* New Parts (新規部品)