



STB9NB60

N - CHANNEL 600V - 0.7Ω - 9A - I²PAK/D²PAK PowerMESH™ MOSFET

| TYPE | V _{DSS} | R _{DS(on)} | I _D |
|----------|------------------|---------------------|----------------|
| STB9NB60 | 600 V | < 0.8 Ω | 9A |

- TYPICAL R_{DS(on)} = 0.7 Ω
- EXTREMELY HIGH dv/dt CAPABILITY
- 100% AVALANCHE TESTED
- VERY LOW INTRINSIC CAPACITANCES
- GATE CHARGE MINIMIZED

DESCRIPTION

Using the latest high voltage MESH OVERLAY™ process, STMicroelectronics has designed an advanced family of power MOSFETs with outstanding performances. The new patent pending strip layout coupled with the Company's proprietary edge termination structure, gives the lowest R_{DS(on)} per area, exceptional avalanche and dv/dt capabilities and unrivalled gate charge and switching characteristics.

APPLICATIONS

- HIGH CURRENT, HIGH SPEED SWITCHING
- SWITCH MODE POWER SUPPLIES (SMPS)
- DC-AC CONVERTERS FOR WELDING EQUIPMENT AND UNINTERRUPTIBLE POWER SUPPLIES AND MOTOR DRIVE

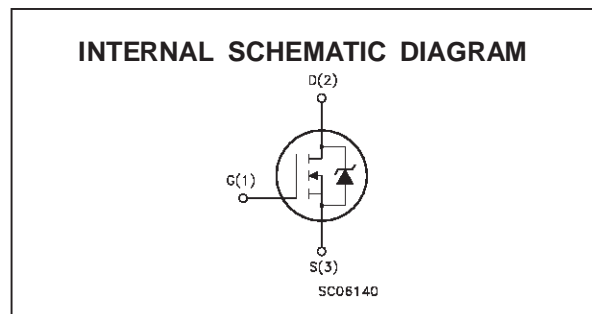
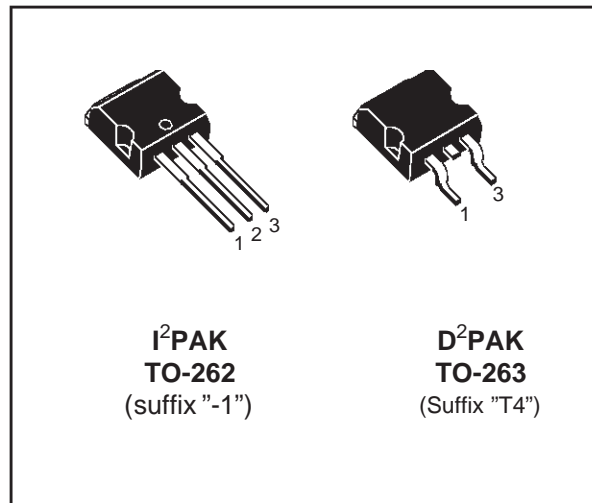

ABSOLUTE MAXIMUM RATINGS

| Symbol | Parameter | Value | Unit |
|---------------------|---|------------|------|
| V _{DS} | Drain-source Voltage (V _{GS} = 0) | 600 | V |
| V _{DGR} | Drain- gate Voltage (R _{GS} = 20 kΩ) | 600 | V |
| V _{GS} | Gate-source Voltage | ± 30 | V |
| I _D | Drain Current (continuous) at T _c = 25 °C | 9 | A |
| I _D | Drain Current (continuous) at T _c = 100 °C | 5.7 | A |
| I _{DM} (•) | Drain Current (pulsed) | 36 | A |
| P _{tot} | Total Dissipation at T _c = 25 °C | 125 | W |
| | Derating Factor | 1 | W/°C |
| dv/dt(1) | Peak Diode Recovery voltage slope | 4.5 | V/ns |
| T _{stg} | Storage Temperature | -65 to 150 | °C |
| T _j | Max. Operating Junction Temperature | 150 | °C |

(•) Pulse width limited by safe operating area

(1) I_{SD} ≤ 9A, di/dt ≤ 200 A/μs, V_{DD} ≤ V_{(BR)DSS}, T_j ≤ T_{JMAX}

STB9NB60

THERMAL DATA

| | | | | |
|-----------------------|--|-----|------|------|
| R _{thj-case} | Thermal Resistance Junction-case | Max | 1 | °C/W |
| R _{thj-amb} | Thermal Resistance Junction-ambient | Max | 62.5 | °C/W |
| R _{thc-sink} | Thermal Resistance Case-sink | Typ | 0.5 | °C/W |
| T _I | Maximum Lead Temperature For Soldering Purpose | | 300 | °C |

AVALANCHE CHARACTERISTICS

| Symbol | Parameter | Max Value | Unit |
|-----------------|--|-----------|------|
| I _{AR} | Avalanche Current, Repetitive or Not-Repetitive (pulse width limited by T _j max) | 9 | A |
| E _{AS} | Single Pulse Avalanche Energy (starting T _j = 25 °C, I _D = I _{AR} , V _{DD} = 50 V) | 850 | mJ |

ELECTRICAL CHARACTERISTICS (T_{case} = 25 °C unless otherwise specified)

OFF

| Symbol | Parameter | Test Conditions | Min. | Typ. | Max. | Unit |
|----------------------|---|--|------|------|---------|----------|
| V _{(BR)DSS} | Drain-source Breakdown Voltage | I _D = 250 μA V _{GS} = 0 | 600 | | | V |
| I _{DSS} | Zero Gate Voltage Drain Current (V _{GS} = 0) | V _{DS} = Max Rating V _{DS} = Max Rating T _c = 125 °C | | | 1 50 | μA μA |
| I _{GSS} | Gate-body Leakage Current (V _{DS} = 0) | V _{GS} = ± 30 V | | | ± 100 | nA |

ON (*)

| Symbol | Parameter | Test Conditions | Min. | Typ. | Max. | Unit |
|---------------------|-----------------------------------|---|------|------|------|------|
| V _{GS(th)} | Gate Threshold Voltage | V _{DS} = V _{GS} I _D = 250 μA | 3 | 4 | 5 | V |
| R _{DS(on)} | Static Drain-source On Resistance | V _{GS} = 10V I _D = 3 A | | 0.7 | 0.8 | Ω |
| I _{D(on)} | On State Drain Current | V _{DS} > I _{D(on)} × R _{DS(on)max} V _{GS} = 10 V | 9 | | | A |

DYNAMIC

| Symbol | Parameter | Test Conditions | Min. | Typ. | Max. | Unit |
|---------------------|------------------------------|--|------|------|------|------|
| g _{fs} (*) | Forward Transconductance | V _{DS} > I _{D(on)} × R _{DS(on)max} I _D = 4.5 A | 3 | 6.5 | | S |
| C _{iss} | Input Capacitance | V _{DS} = 25 V f = 1 MHz V _{GS} = 0 | | 1480 | 1924 | pF |
| C _{oss} | Output Capacitance | | | 210 | 273 | pF |
| C _{rss} | Reverse Transfer Capacitance | | | 25 | 33 | pF |

ELECTRICAL CHARACTERISTICS (continued)

SWITCHING ON

| Symbol | Parameter | Test Conditions | Min. | Typ. | Max. | Unit |
|-------------|--------------------|--|------|------|------|------|
| $t_{d(on)}$ | Turn-on Time | $V_{DD} = 300\text{ V}$ $I_D = 4.5\text{ A}$ $R_G = 4.7\ \Omega$ $V_{GS} = 10\text{ V}$ (see test circuit, figure 3) | | 25 | 35 | ns |
| t_r | Rise Time | | | 11 | 15 | ns |
| Q_g | Total Gate Charge | $V_{DD} = 480\text{ V}$ $I_D = 9\text{ A}$ $V_{GS} = 10\text{ V}$ | | 40 | 56 | nC |
| Q_{gs} | Gate-Source Charge | | | 10.5 | | nC |
| Q_{gd} | Gate-Drain Charge | | | 17.5 | | nC |

SWITCHING OFF

| Symbol | Parameter | Test Conditions | Min. | Typ. | Max. | Unit |
|---------------|-----------------------|--|------|------|------|------|
| $t_{r(Voff)}$ | Off-voltage Rise Time | $V_{DD} = 480\text{ V}$ $I_D = 9\text{ A}$ $R_G = 4.7\ \Omega$ $V_{GS} = 10\text{ V}$ | | 12 | 17 | ns |
| t_f | Fall Time | | | 10 | 14 | ns |
| t_c | Cross-over Time | | | 21 | 29 | ns |

SOURCE DRAIN DIODE

| Symbol | Parameter | Test Conditions | Min. | Typ. | Max. | Unit |
|--------------------|-------------------------------|---|------|------|------|---------------|
| I_{SD} | Source-drain Current | | | | 9 | A |
| $I_{SDM}(\bullet)$ | Source-drain Current (pulsed) | | | | 36 | A |
| $V_{SD}(\ast)$ | Forward On Voltage | $I_{SD} = 9\text{ A}$ $V_{GS} = 0$ | | | 1.6 | V |
| t_{rr} | Reverse Recovery Time | $I_{SD} = 9\text{ A}$ $di/dt = 100\text{ A}/\mu\text{s}$ $V_{DD} = 100\text{ V}$ $T_j = 150\text{ }^\circ\text{C}$ | | 600 | | ns |
| Q_{rr} | Reverse Recovery Charge | | | 5.4 | | μC |
| I_{RRM} | Reverse Recovery Current | | | 18 | | A |

(*) Pulsed: Pulse duration = 300 μs , duty cycle 1.5 %

(•) Pulse width limited by safe operating area

Safe Operating Area

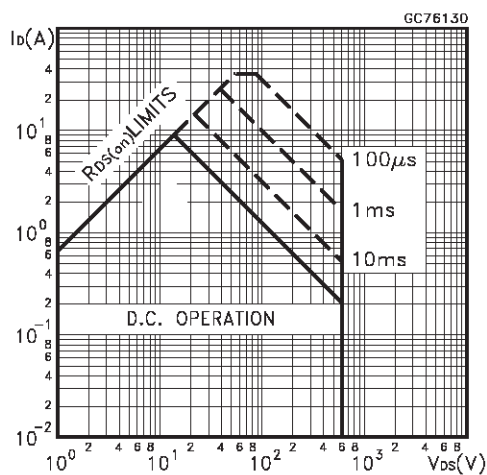

Thermal Impedance

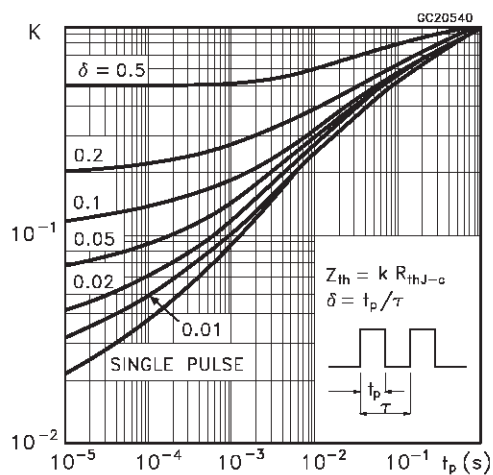

Output Characteristics

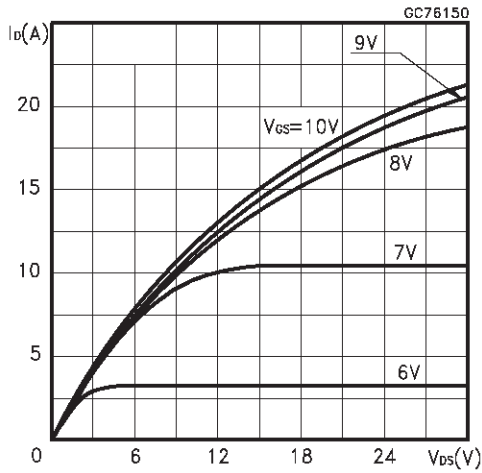

Transfer Characteristics

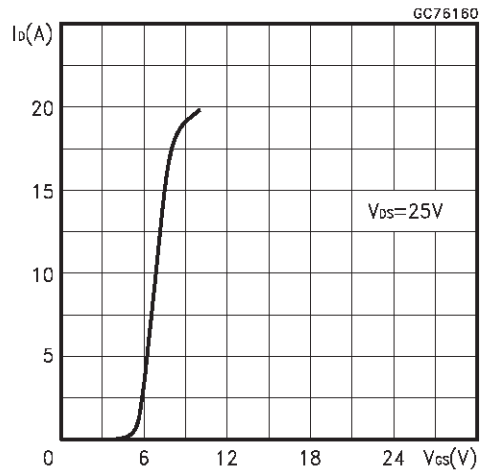

Transconductance

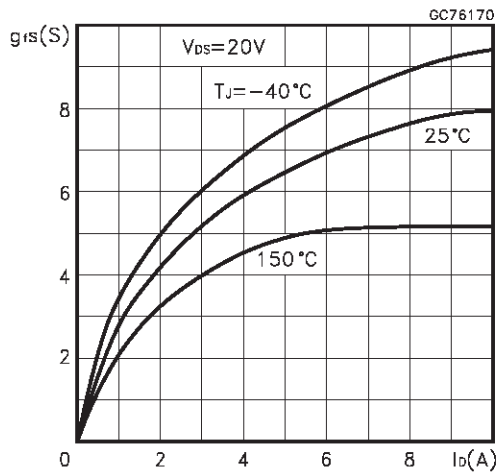

Static Drain-source On Resistance

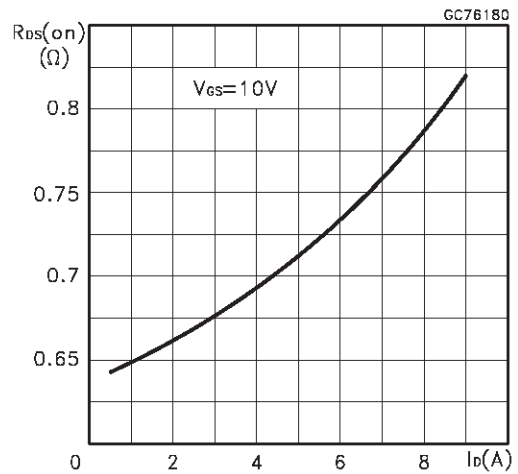

Gate Charge vs Gate-source Voltage

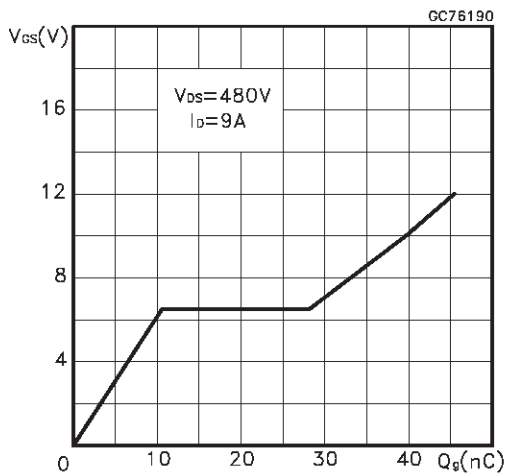

Capacitance Variations

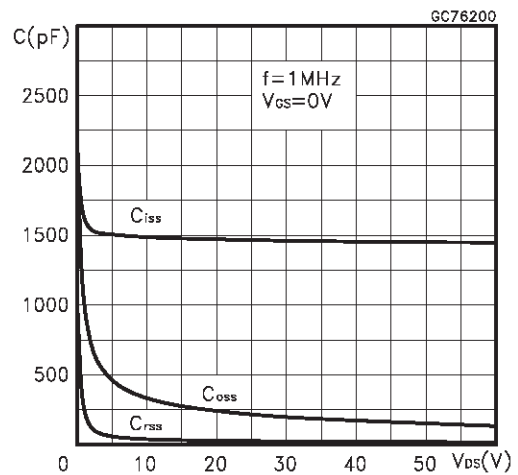

Normalized Gate Threshold Voltage vs Temperature

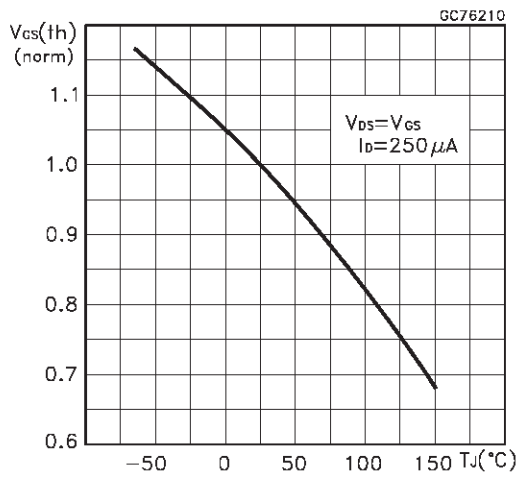

Normalized On Resistance vs Temperature

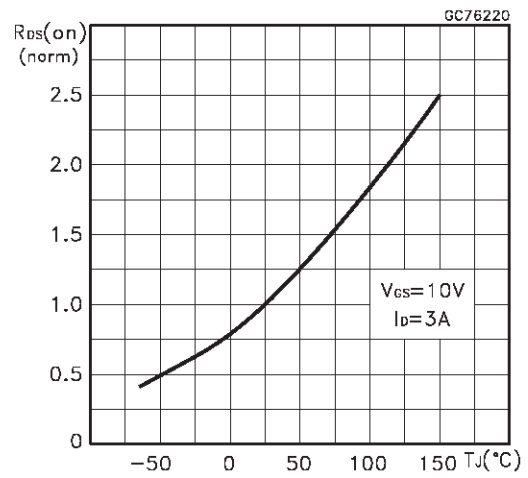

Source-drain Diode Forward Characteristics

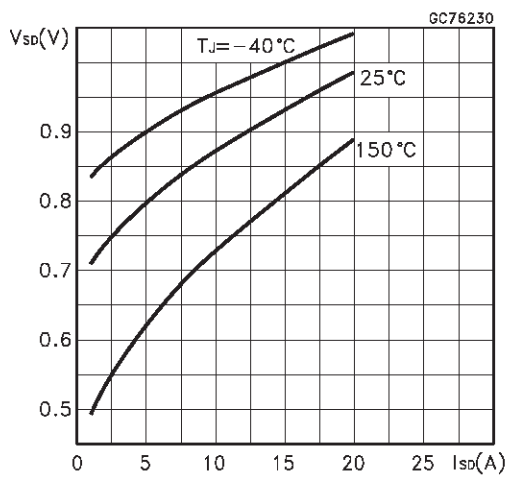

Fig. 1: Unclamped Inductive Load Test Circuit



Fig. 2: Unclamped Inductive Waveform

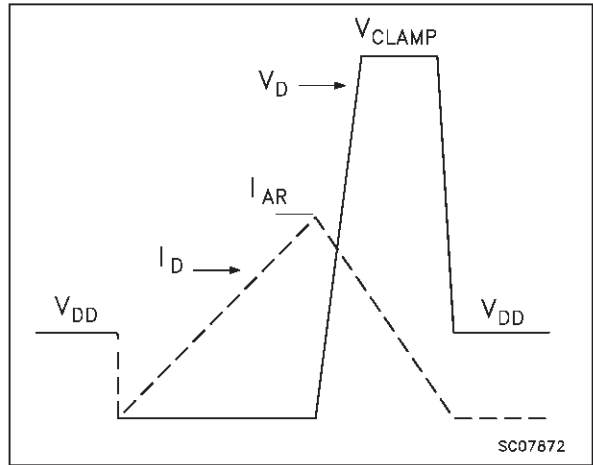

Fig. 3: Switching Times Test Circuits For Resistive Load



Fig. 4: Gate Charge test Circuit

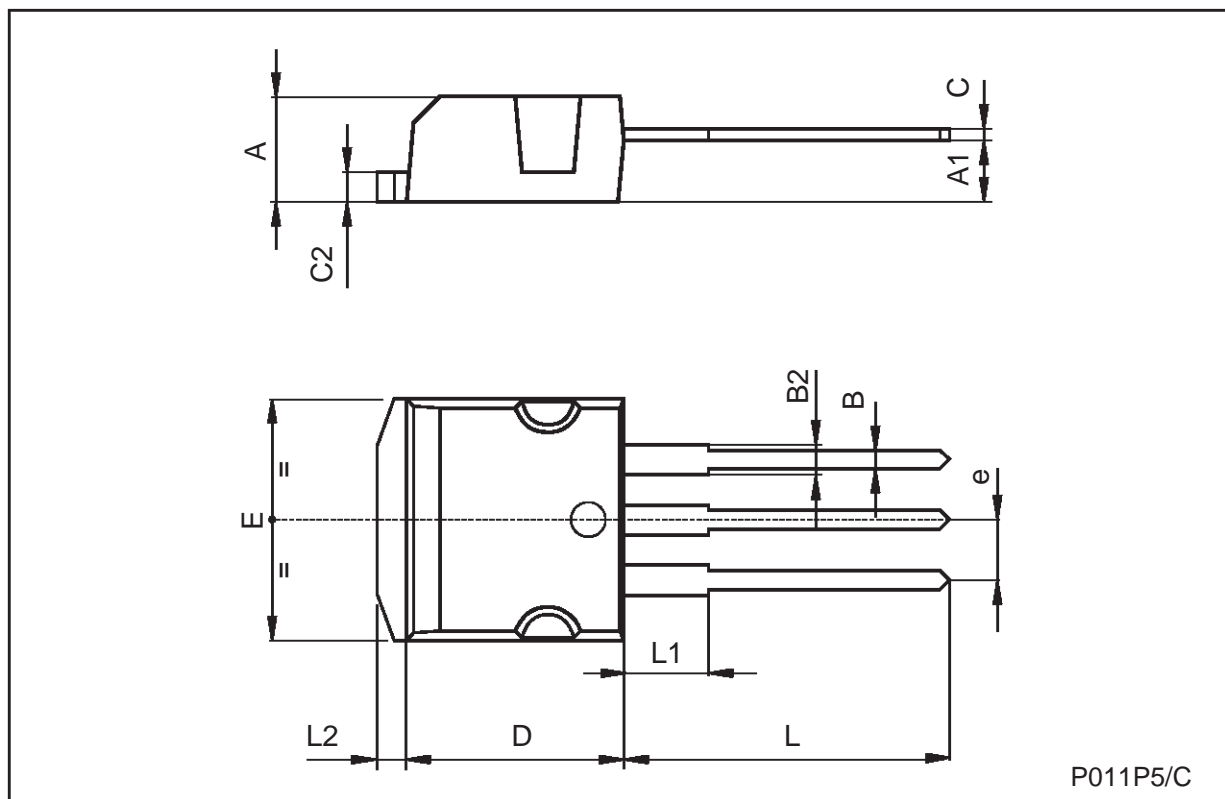

Fig. 5: Test Circuit For Inductive Load Switching And Diode Recovery Times



TO-262 (I2PAK) MECHANICAL DATA

| DIM. | mm | | | inch | | |
|------|------|------|-------|-------|------|-------|
| | MIN. | TYP. | MAX. | MIN. | TYP. | MAX. |
| A | 4.3 | | 4.6 | 0.169 | | 0.181 |
| A1 | 2.49 | | 2.69 | 0.098 | | 0.106 |
| B | 0.7 | | 0.93 | 0.027 | | 0.036 |
| B1 | 1.2 | | 1.38 | 0.047 | | 0.054 |
| B2 | 1.25 | | 1.4 | 0.049 | | 0.055 |
| C | 0.45 | | 0.6 | 0.017 | | 0.023 |
| C2 | 1.21 | | 1.36 | 0.047 | | 0.053 |
| D | 8.95 | | 9.35 | 0.352 | | 0.368 |
| e | 2.44 | | 2.64 | 0.096 | | 0.104 |
| E | 10 | | 10.28 | 0.393 | | 0.404 |
| L | 13.2 | | 13.5 | 0.519 | | 0.531 |
| L1 | 3.48 | | 3.78 | 0.137 | | 0.149 |
| L2 | 1.27 | | 1.4 | 0.050 | | 0.055 |



TO-263 (D²PAK) MECHANICAL DATA

| DIM. | mm | | | inch | | |
|------|------|------|-------|-------|------|-------|
| | MIN. | TYP. | MAX. | MIN. | TYP. | MAX. |
| A | 4.3 | | 4.6 | 0.169 | | 0.181 |
| A1 | 2.49 | | 2.69 | 0.098 | | 0.106 |
| B | 0.7 | | 0.93 | 0.027 | | 0.036 |
| B2 | 1.25 | | 1.4 | 0.049 | | 0.055 |
| C | 0.45 | | 0.6 | 0.017 | | 0.023 |
| C2 | 1.21 | | 1.36 | 0.047 | | 0.053 |
| D | 8.95 | | 9.35 | 0.352 | | 0.368 |
| E | 10 | | 10.28 | 0.393 | | 0.404 |
| G | 4.88 | | 5.28 | 0.192 | | 0.208 |
| L | 15 | | 15.85 | 0.590 | | 0.624 |
| L2 | 1.27 | | 1.4 | 0.050 | | 0.055 |
| L3 | 1.4 | | 1.75 | 0.055 | | 0.068 |

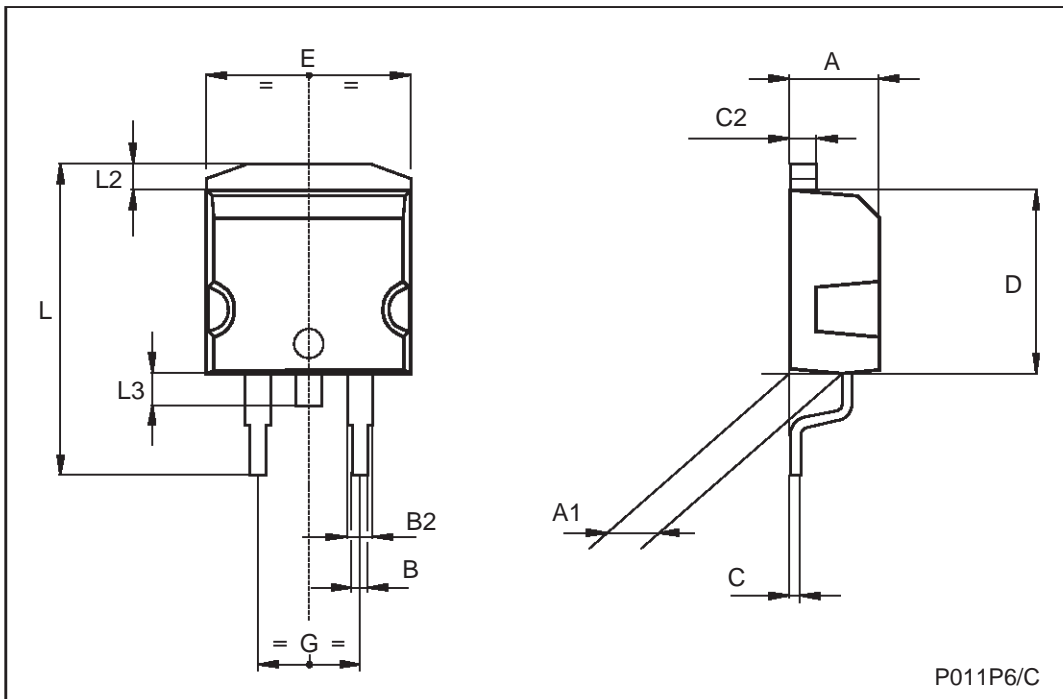

Information furnished is believed to be accurate and reliable. However, STMicroelectronics assumes no responsibility for the consequences of use of such information nor for any infringement of patents or other rights of third parties which may result from its use. No license is granted by implication or otherwise under any patent or patent rights of STMicroelectronics. Specification mentioned in this publication are subject to change without notice. This publication supersedes and replaces all information previously supplied. STMicroelectronics products are not authorized for use as critical components in life support devices or systems without express written approval of STMicroelectronics.

The ST logo is a trademark of STMicroelectronics

© 1999 STMicroelectronics – Printed in Italy – All Rights Reserved
STMicroelectronics GROUP OF COMPANIES

Australia - Brazil - China - Finland - France - Germany - Hong Kong - India - Italy - Japan - Malaysia - Malta - Morocco -
Singapore - Spain - Sweden - Switzerland - United Kingdom - U.S.A.

<http://www.st.com>

