

# CUBE-100

# SERVICE NOTES

SPECIFICATIONS

Output Power ----- 100W rms into 8 ohm load  
 Speaker ----- 30cm x 1  
 Power Consumption ----- 245VA  
 Dimensions ----- 296(W) x 465(H) x 264(D)mm  
 Weight ----- 20kg

CORRECTIONAL  
 Mackle (halftone misregistration)

N prefixed to abbreviated Part Number stands for "No." to distinguish it from old 6 digit P/N not being used in this Notes.

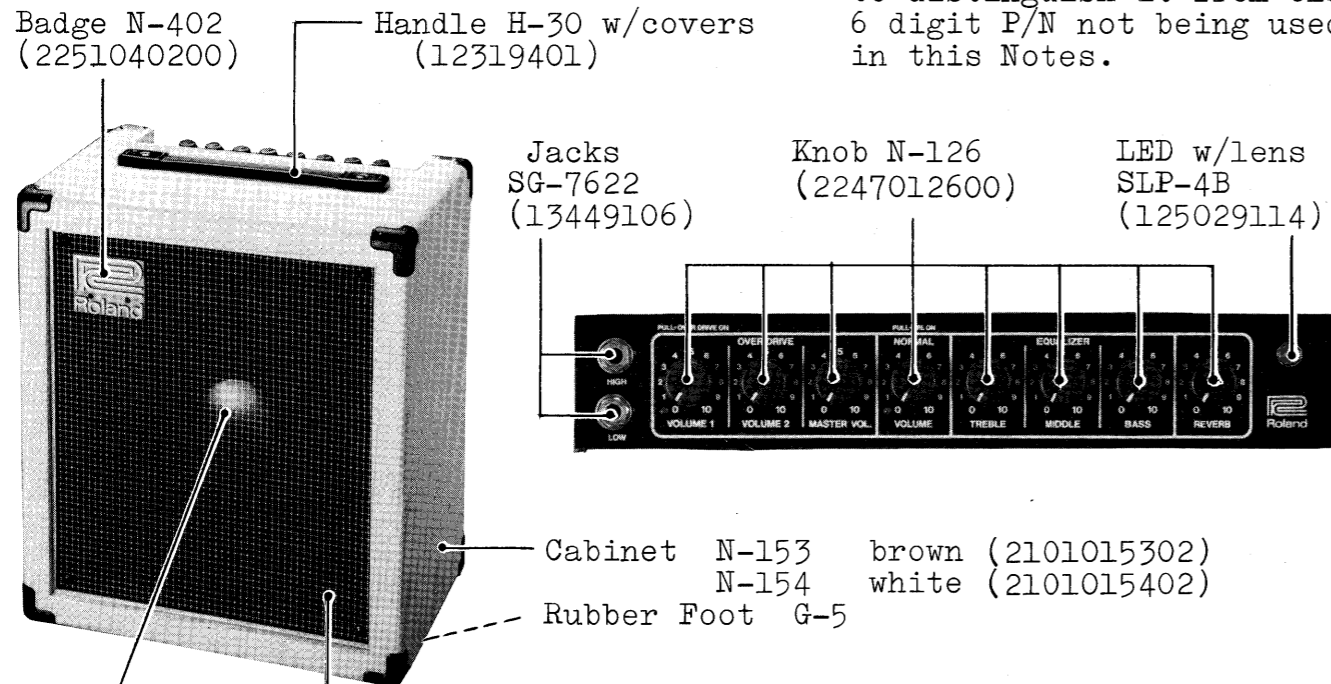

Cabinet N-153 brown (2101015302)  
 N-154 white (2101015402)  
 Rubber Foot G-5  
 Speaker PD-3006A (2241020900)  
 Baffle & Grille Cloth N-114 (2117011400)

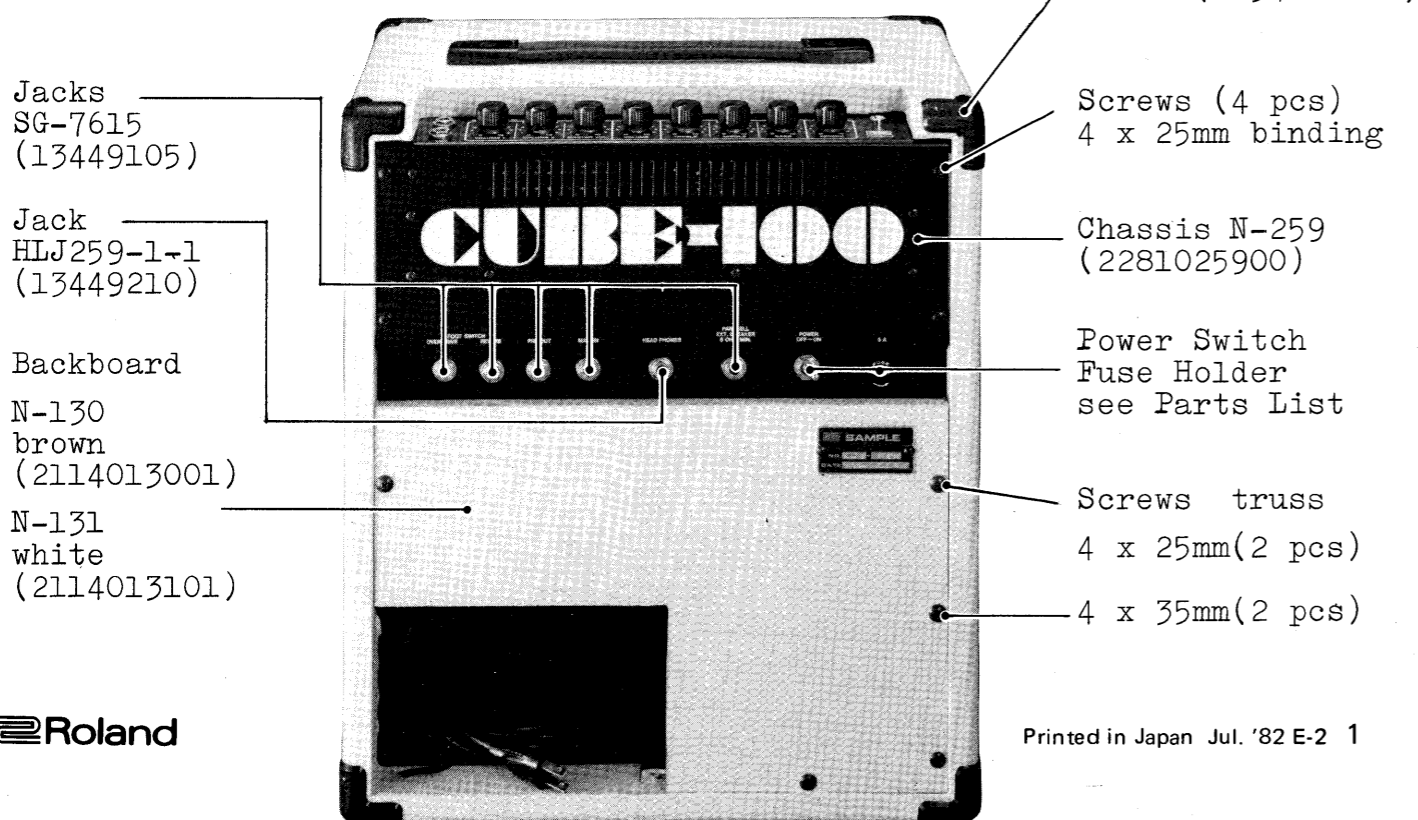

MAIN AMP AP0138-080A (P/N 7013808002) (PCB 2291033701)

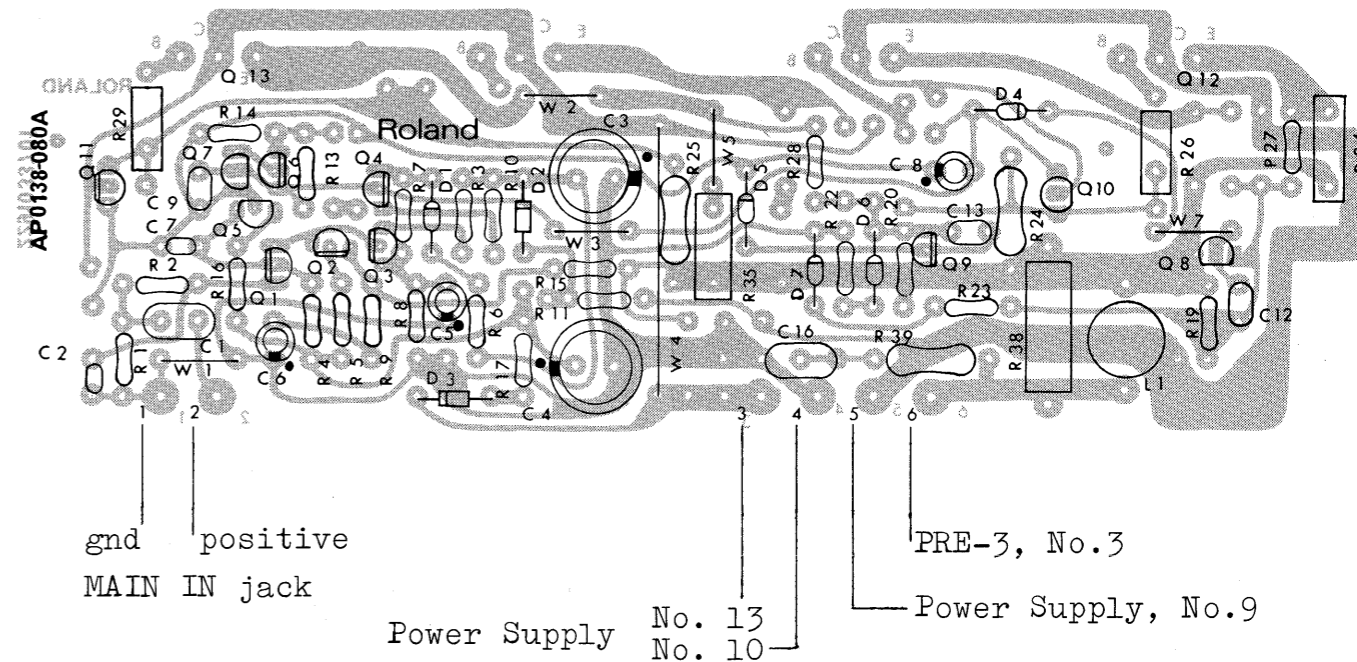

PRE AMP

AP0138-060-1 (P/N 7013806002-1)  
 AP0138-060-2 (P/N 7013806002-2)  
 AP0138-060-3 (P/N 7013806002-3)  
 (PCB no. -given to -1A only  
 2291041900)

PRE OUT jack, positive  
 ground  
 Power No. 10  
 Supply No. 14  
 Board No. 16  
 No. 8

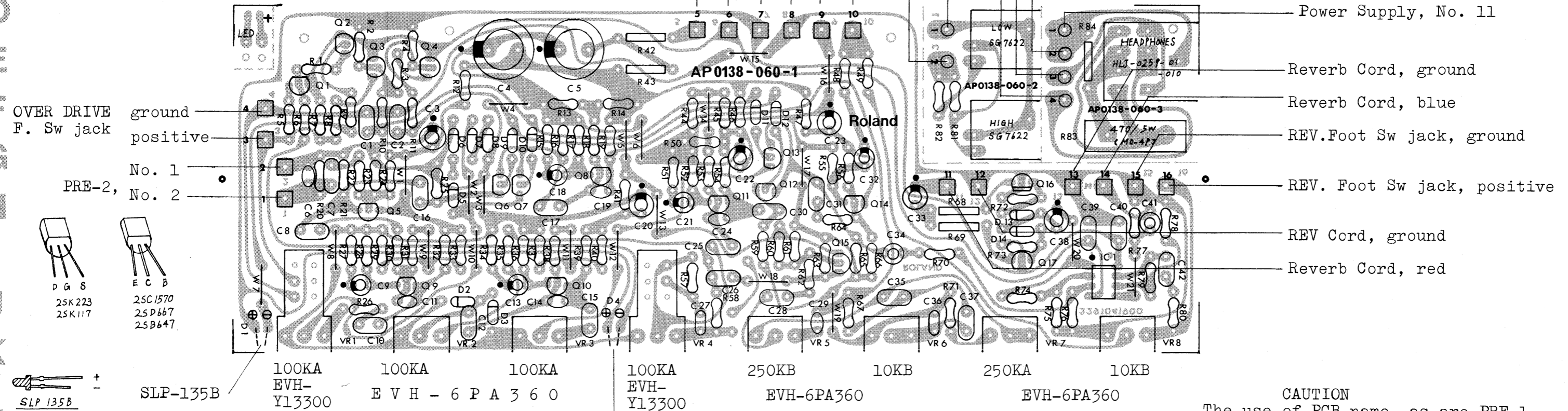

CAUTION  
 The use of PCB name, as are PRE-1, PRE-2, is confined only in this section. The purpose is for easier terminal-to-terminal wiring tracking.

	F1, F2	FUSE HOLDER
100V	5A 125V	TF-757
117V	5A 125V	TF-757
220/240V	T5A 250V	TF-758

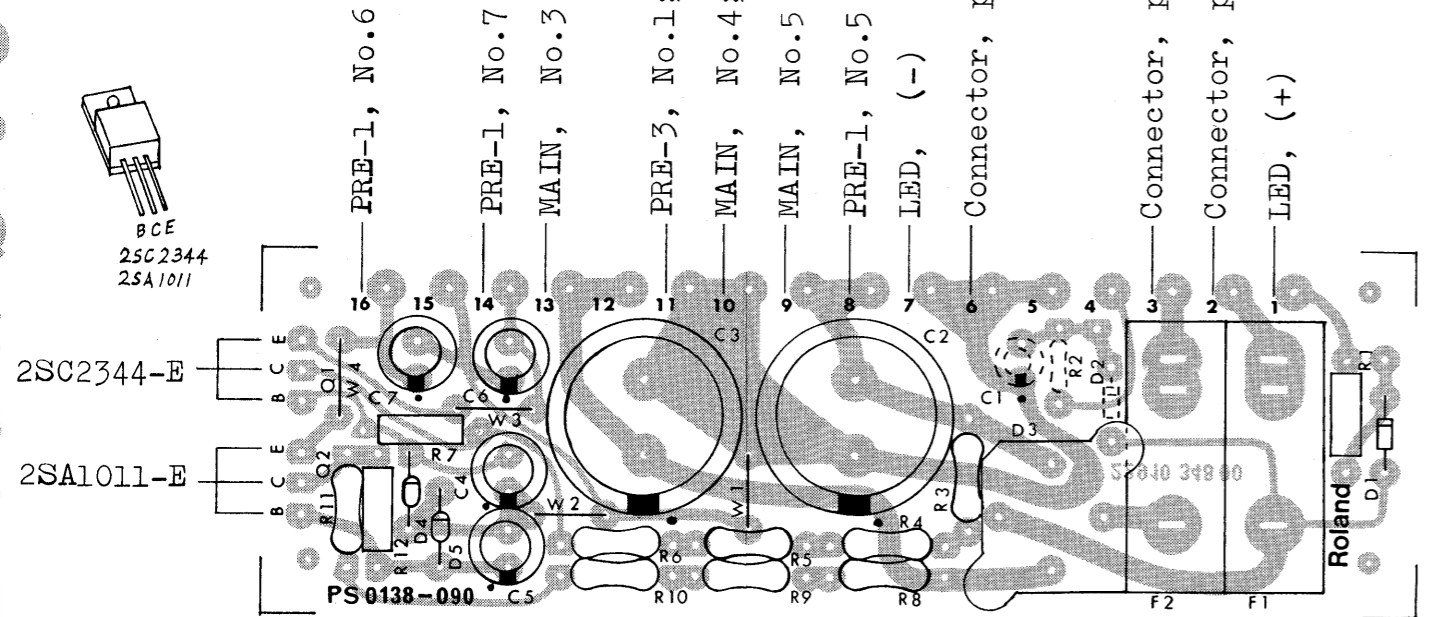

POWER SUPPLY (P/N 7013809003) (PCB 2291034800)

1 2 3 4 5 6 7 8 9 10 11 12 13 14 15 16 17 18 19 20 21 22 23 24 25 26 27 28 29 30 31 32 33 34 35 36 37 38 39 40 41

A  
B  
C  
D  
E  
F  
G  
H  
I  
J  
K  
L  
M  
N  
O  
P  
Q  
R  
S  
T  
U  
V

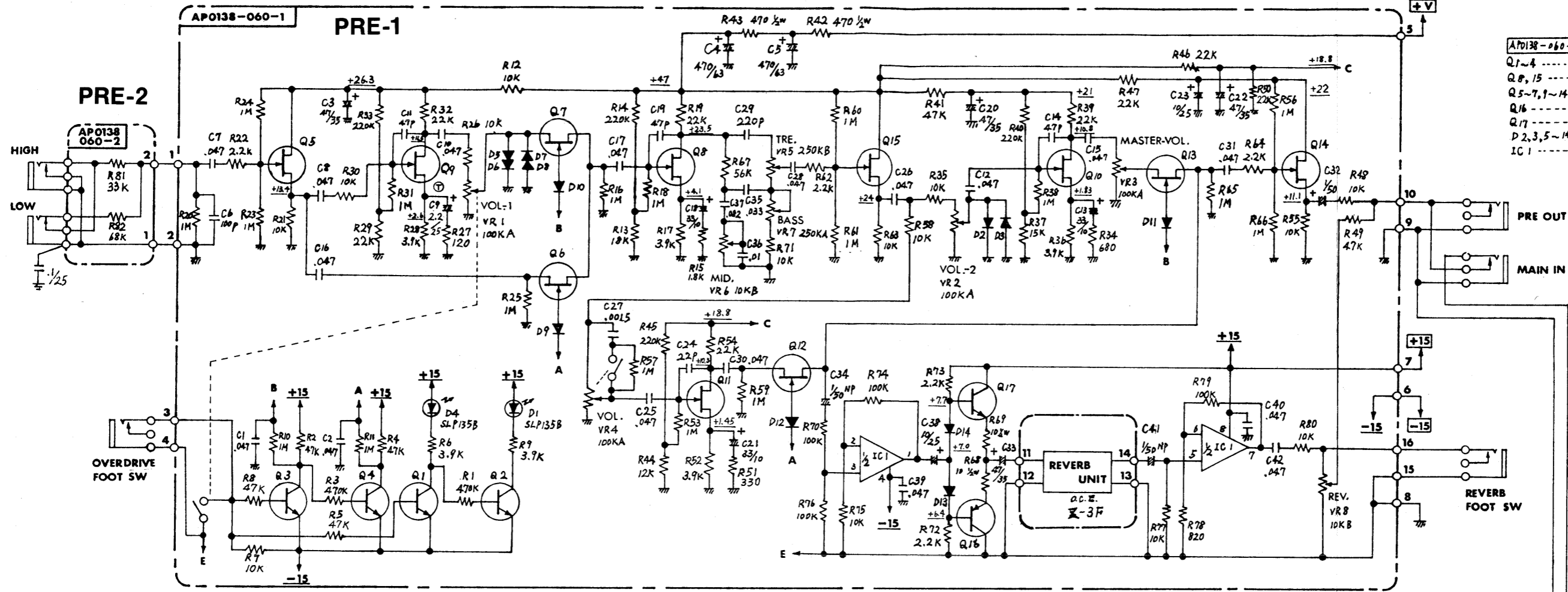

- AP0138-060-1
- Q1-4 ..... 2SC1570 GmF
  - Q8, 15 ..... 26K 223 GmF
  - Q5-7, 9-14 ..... 25K 117 GR
  - Q16 ..... 2SD667 C
  - Q17 ..... 2SB647 C
  - D2, 3, 5-14 ..... 1S2473
  - IC 1 ..... NJM4558 Df

Power Transformer  
Secondary ratings

1.7A dc @ 49V  
x 2

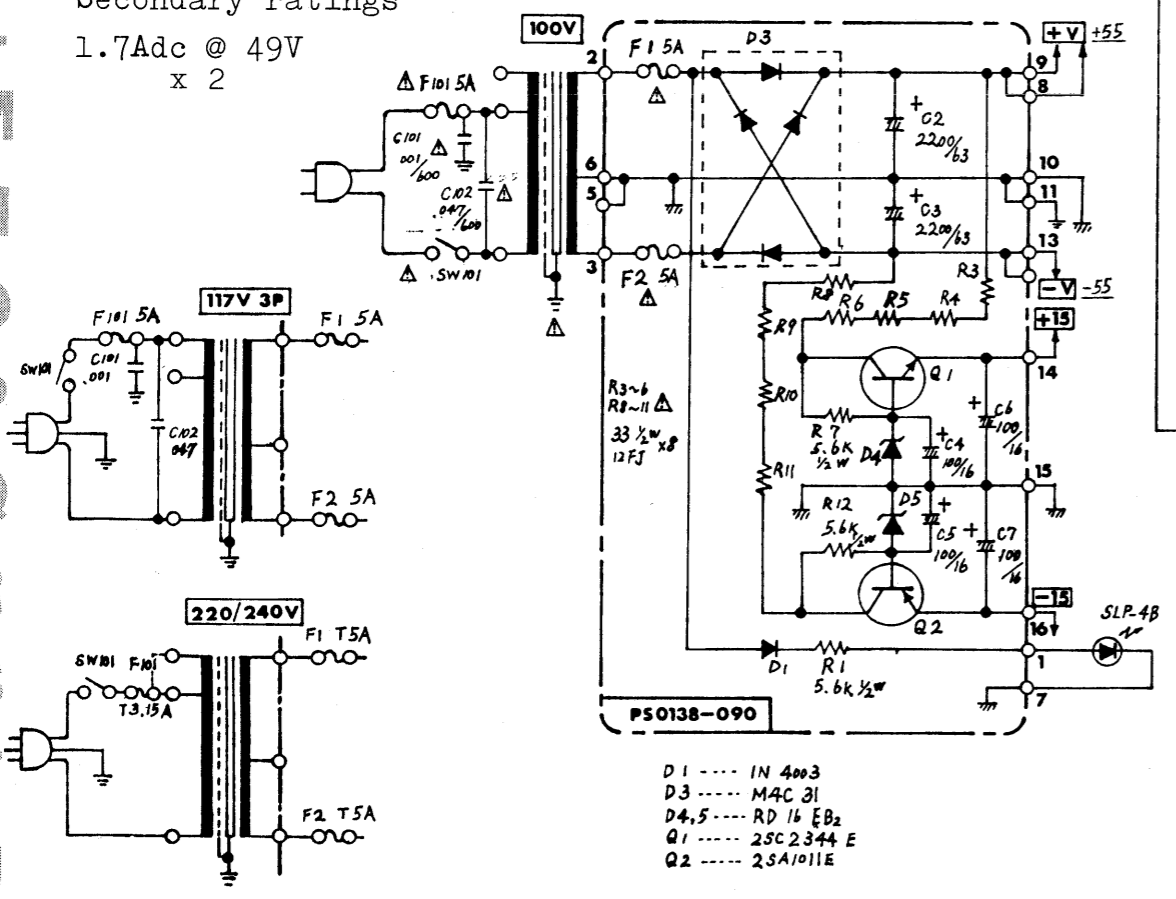

- PS0138-090
- D1 ..... 1N 4003
  - D3 ..... M4C 3I
  - D4, 5 ..... RD 16 EB2
  - Q1 ..... 2SC2344 E
  - Q2 ..... 2SA1016 E

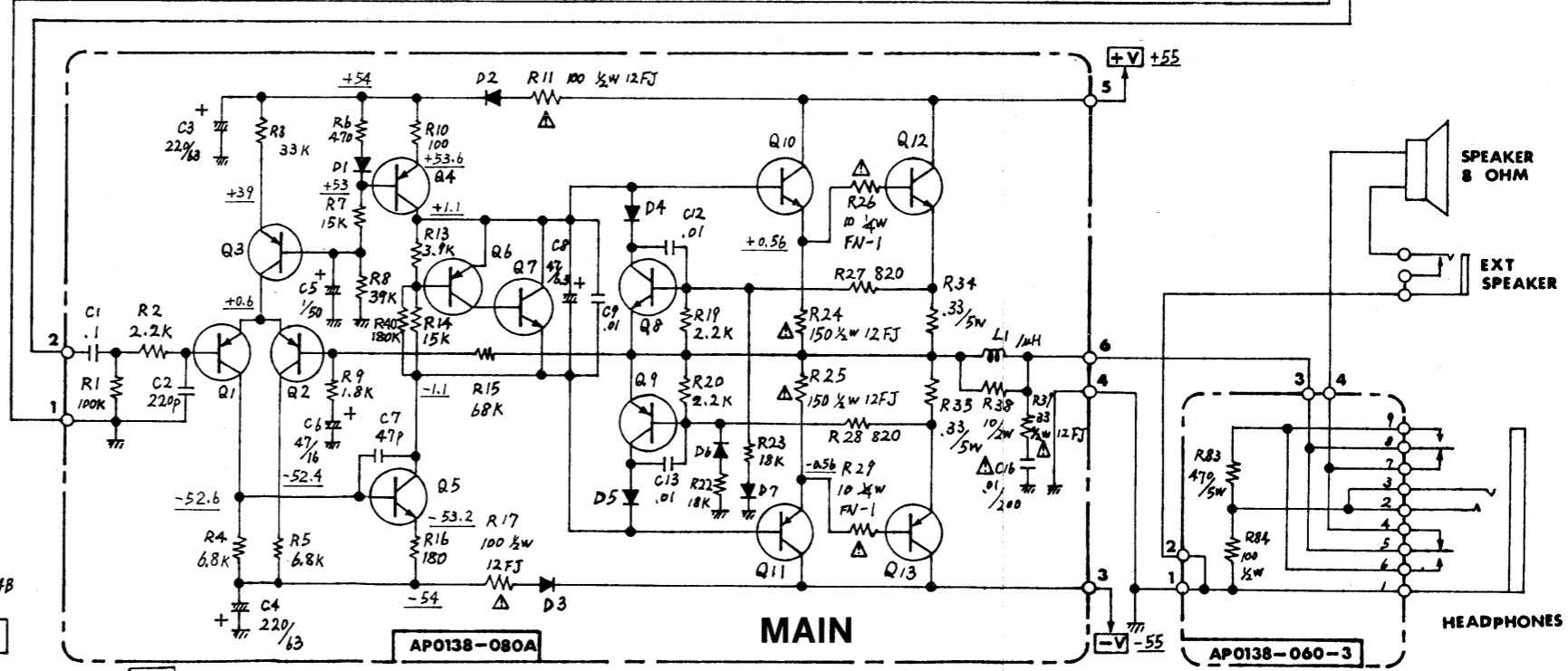

- AP0138-080A
- 2SD668A
  - 2SB448A
  - 2SD667A
  - 2SB649A

- AP0138-080
- Q1-3, 6, 9 --- 2SA1016 K G
  - Q4 ..... 2SB648A C
  - Q5 ..... 2SD668A C
  - Q7, 8 ..... 2SC2362 K G

- PRE-3
- Q10 ..... 2SD667A C
  - Q11 ..... 2SB649A C
  - Q12 ..... 2SD845 O or R
  - Q13 ..... 2SB7550 or R
  - D1, 4-7 ..... 1S1585
  - D2, 3 ..... 1N4003

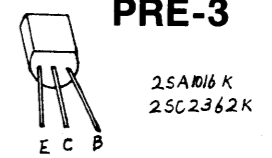

**PARTS LIST**

**NOTES:**

Last two digits of a Part Number (P/N) will increase by one as a modification is taken on the part.

When a modification is greater in terms of circuit configuration, compatibility and so forth, a letter (A, B, C, ..... ) is suffixed to assembly number, name or N-... (N explained below).

Information will accompany with such a part when it is a substitutive for its former type as a replacement.

Not in this Parts List, 6 digit number was used for part coding in stead of 8-10 digit.

"N" prefixed to abbreviated P/N stands for "No." to distinguish between two systems in calling P/N for short.

When ordering, do not use No. for N. or rather, use full number.

**CABINET ASSEMBLY**

2101015302	Cabinet N-153	brown
2101015402	Cabinet N-154	white
2114013001	Backboard N-130	brown
2114013101	Backboard N-131	white
12319401	Handle H-30	w/cover
2117011400	Baffle & Grille cloth N-114	
2251040200	Badge (logo) N-402	
2234020100	Corner protector N-201	Rubber foot G-5
2241020900	Speaker PD-3006A	

**CHASSIS**

2281025900	Chassis N-259
2219025901	Holder N-259 Rev.unit
2202080700	Cover N-807 Rev. unit spongy
2247012600	Knob N-126
13449105	Jack SG-7615 rear panel
13449210	Jack HLJ-259-1-1 rear PHONES
13449106	Jack SG-7622 control panel
12389101	Reverb unit Z-3F

**SWITCH**

13139520	DS-140	power	100V
13139506	S-6B-7	power	117V
13139501	GNP-1	power	220/240V

**PCB ASSEMBLY**

7013806002-1	AP0138-060-1	PRE
7013806002-2	AP0138-060-2	PRE, input jack
7013806002-3	AP0138-060-3	PRE, H-phones jack (pcb 2291041900) Sinde PRE pcb is divided into three after assembly, pcb number is given only once collectively.
7013808002	AP0138-080A	MAIN (pcb 2291033701)
7013809003	PS0138-090	POWER SUPPLY (pcb 2291034800)

**SEMICONDUCTOR**

**Transistor**

15129602	2SD667C
15119602	2SB647C
15129111	2SC1570- F or G
15119115	2SA1016K-G
15129125	2SC2362K-G
15129603	2SD668A-C
15119603	2SB648A-C
15129604	2SD669A-C
15119604	2SB649A-C
15129707	2SC2344-E
15119704	2SA1011-E
15129818	2SD845- 0 or R power
15119807	2SB755- 0 or R power
15139106	2SK117-GR FET
15139109	2SK223- F or G FET

**Diode**

15019103	1S2473
150123	1S1585 15019123
15019205	1N4003
15019237	M4C-31 rectifier
15019560	RD-16EB2 zener
15029117	SLP-135B LED red
15029114	SLP-4B LED red w/lens

**IC**

15189103	NJM4558DP
----------	-----------

**TRANSFORMER**

22450225N0	PT N-225	100/117V
22450226C0	PT N-226	117V with CSA mark
22450227D0	PT N-227	220/240V

**CAPACITOR**

**Polypropylene**

13549863M0	ECQ-M6102MZ	0.001 mfd	(C101) 100V
13549883M0	ECQ-M6473MZ	0.047 mfd	(C102) 100V
13589451M0	ECQ-UC1A102MC	0.001 mfd	(C101) 117V
13589453M0	ECQ-UC1A473MC	0.047 mfd	(C102) 117V
13549625M0	ECQ-M2103KZ	0.01 mfd	(C16 MAIN)

**Electrolytic**

13549863M0	ECET-63R222SW	2200/63
13639150M0	ECEA-1CV101S	100/16

**POTENTIOMETER**

13219810	EVH-Y13300	100KA w/push-pull sw
13219109	EVH-6PA360	250KA
13219110	EVH-6PA360	100KA
13219113	EVH-6PA360	10KB
13219117	EVH-6PA360	250KB

**RESISTOR**

**Noninflammable 1/2W**

13829803M0	ERD-12FJ	33 ohms
13829808M0	ERD-12FJ	100 ohms
13829810M0	ERD-12FJ	150 ohms
12559705	FRN	10 ohm 1/4w fusible
13839102F0	MO-4S	10 ohm 2w cement
13839607F0	MO-4P	470 ohm 5w cement
13869301	MPC-71	0.33 ohm 5w metal

**OTHERS**

2343073500	Cord N-735	blue, Rev out
2343074200	Cord N-742	red, Rev in
13439113	Plug	
13439113	Connector housing,	plug 3191-09P-P
13429111	Connector housing	receptacle 3191-09P-R (PT-Power Supply Board)

2267013701 \* Vinyl cover N-137

2262021901 \* Carton N-219

\* not considered to be ordinary spare parts