

# Footswitch Wiring Guide

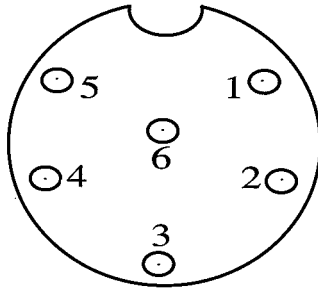

326 Hwy 11/80 East Meridian, MS 39301

# CENTURION MK-3

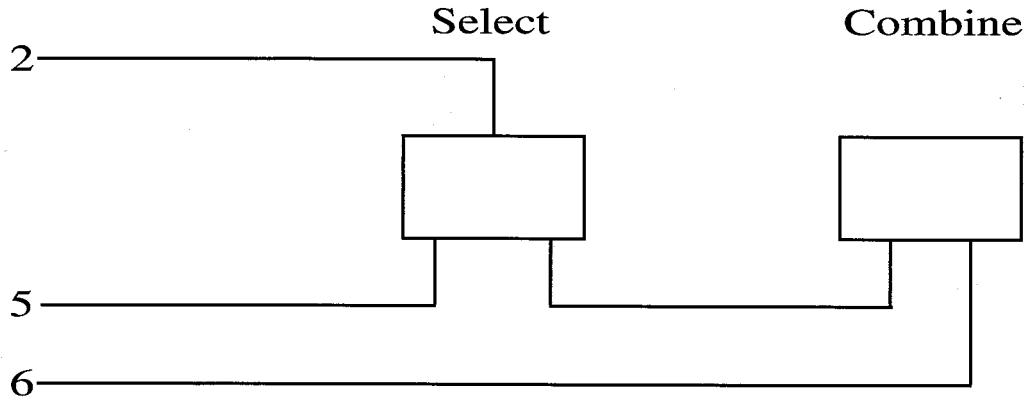

← solder side of 6 pin DIN

---

# 5150 FTSW

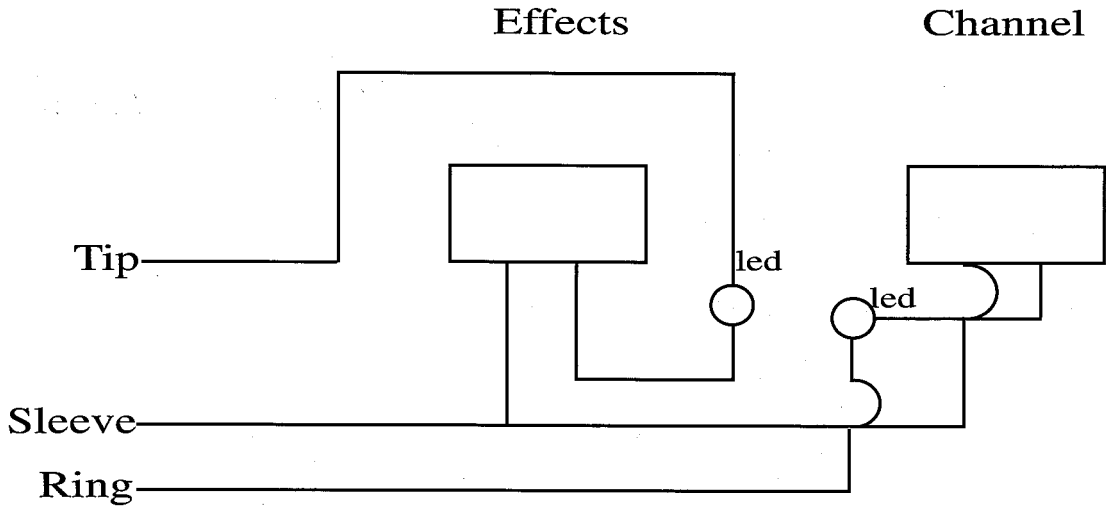

# RENOWN-112/212 #57022

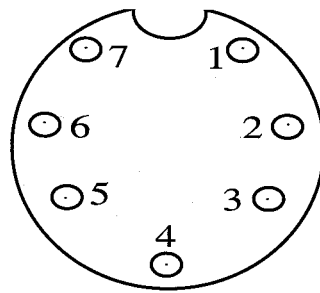
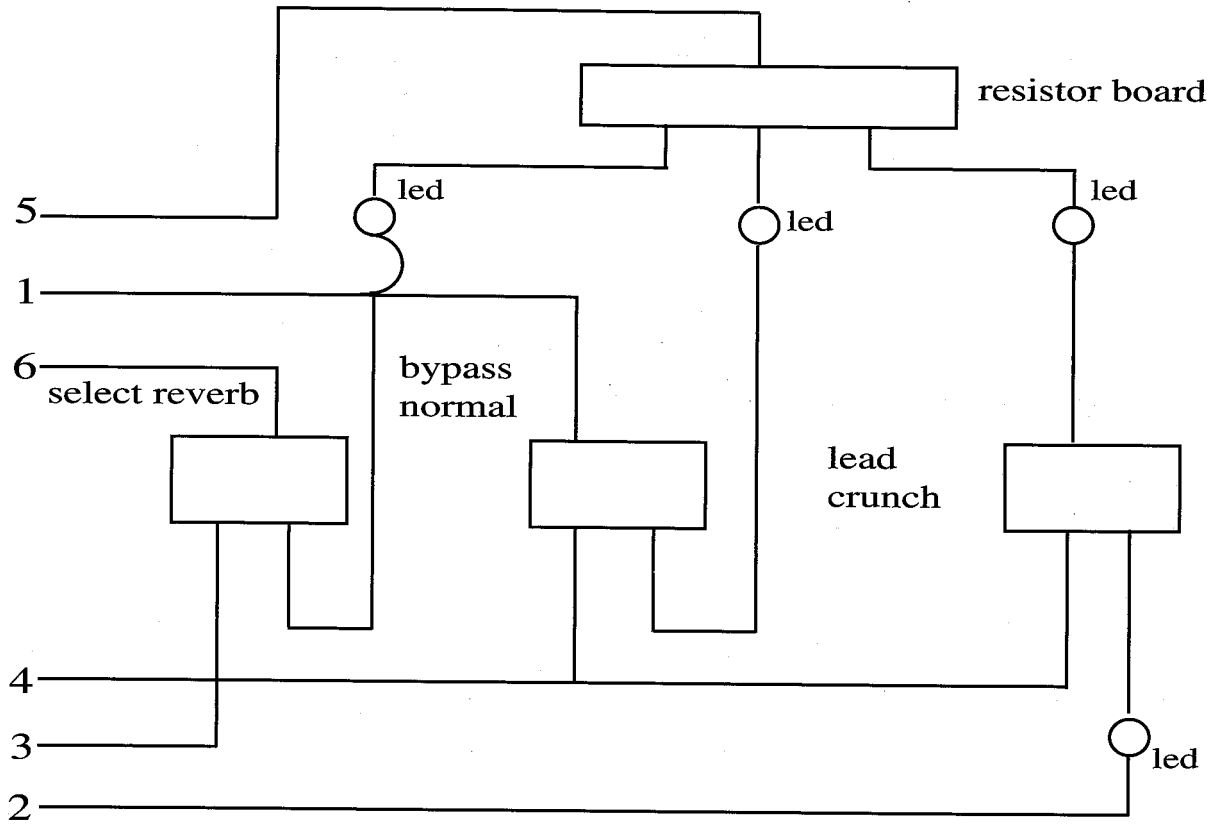

← solder side of 7 pin DIN

# TRIUMPH PAG-60/120

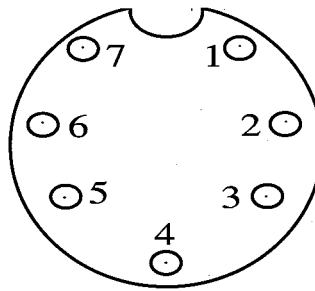
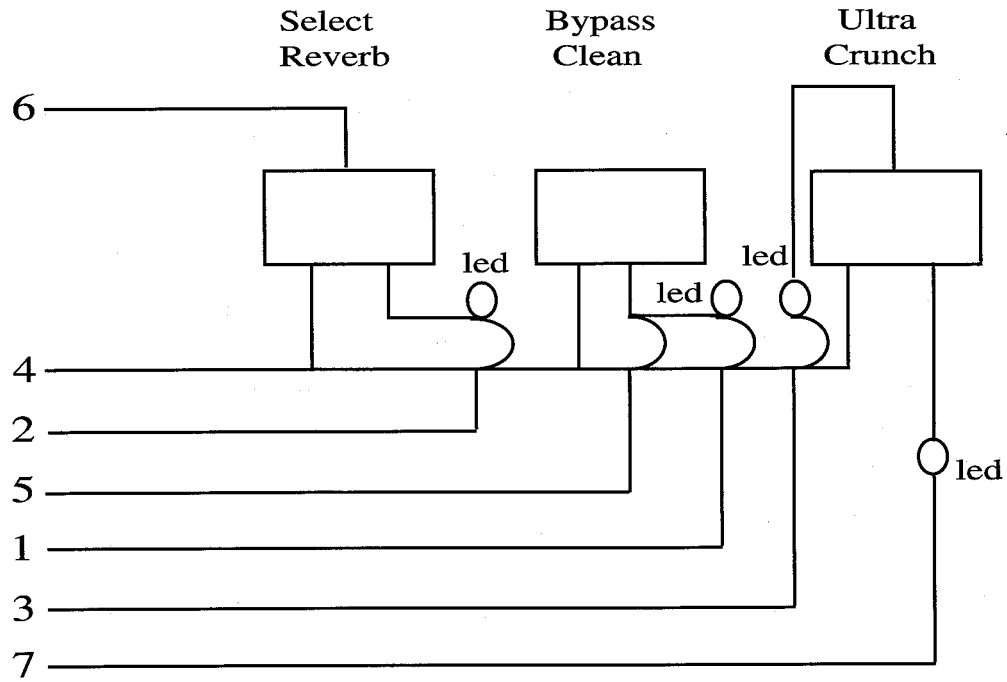

← solder side of 7 pin DIN

# Stereo Chorus 400

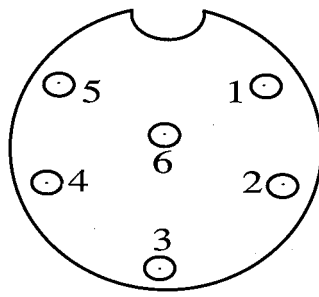
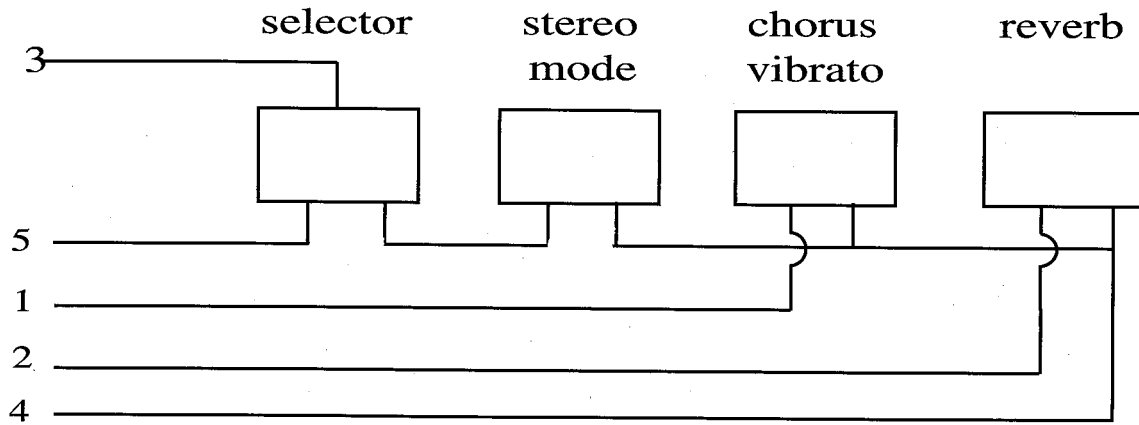

---

# CLASSIC VTX Footswitch

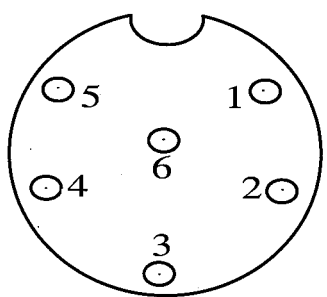
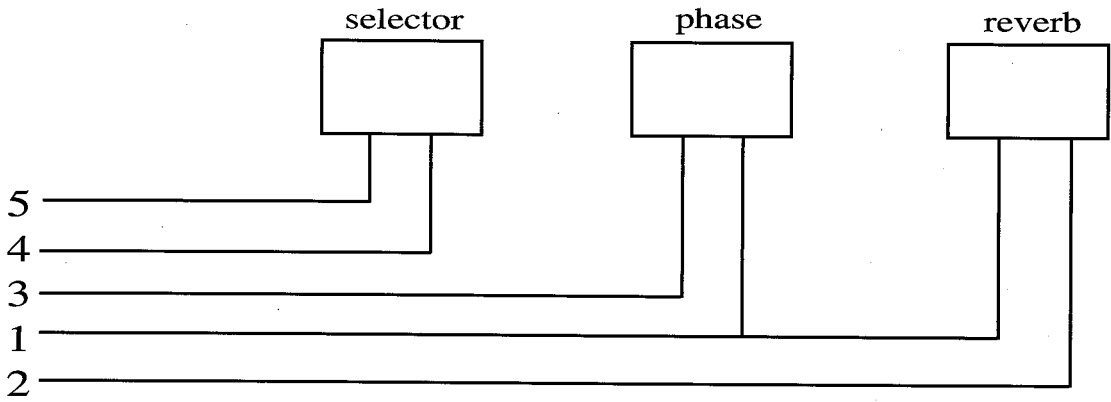

← solder side of 6 pin DIN

# Classic Chorus 212, Studio Chorus 210, Backstage 208

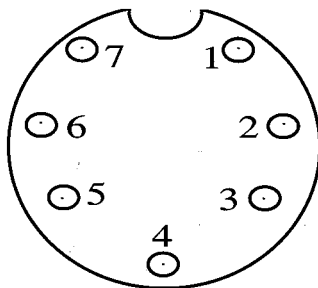
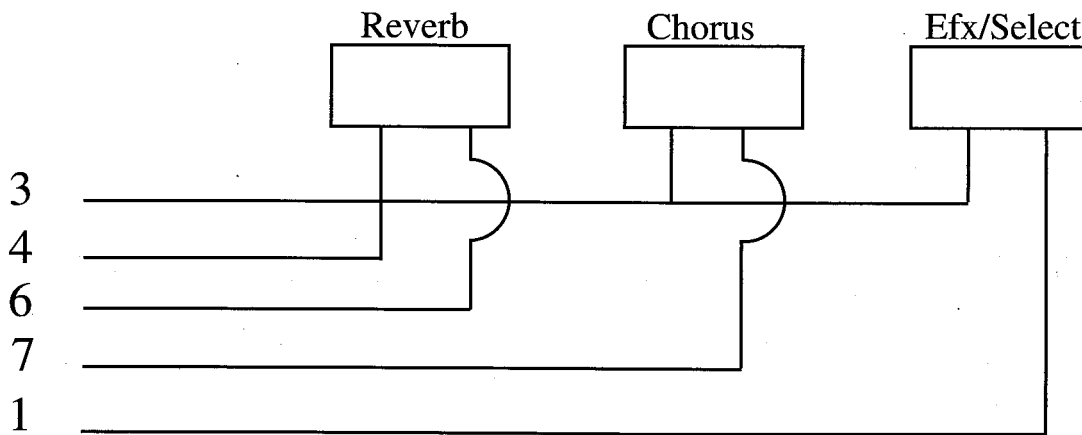

← solder side of 7 pin DIM

## Stereo Chorus 212

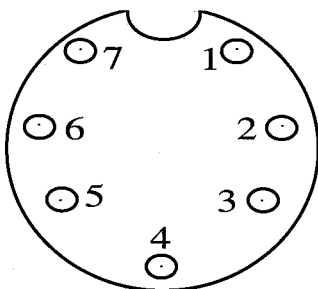
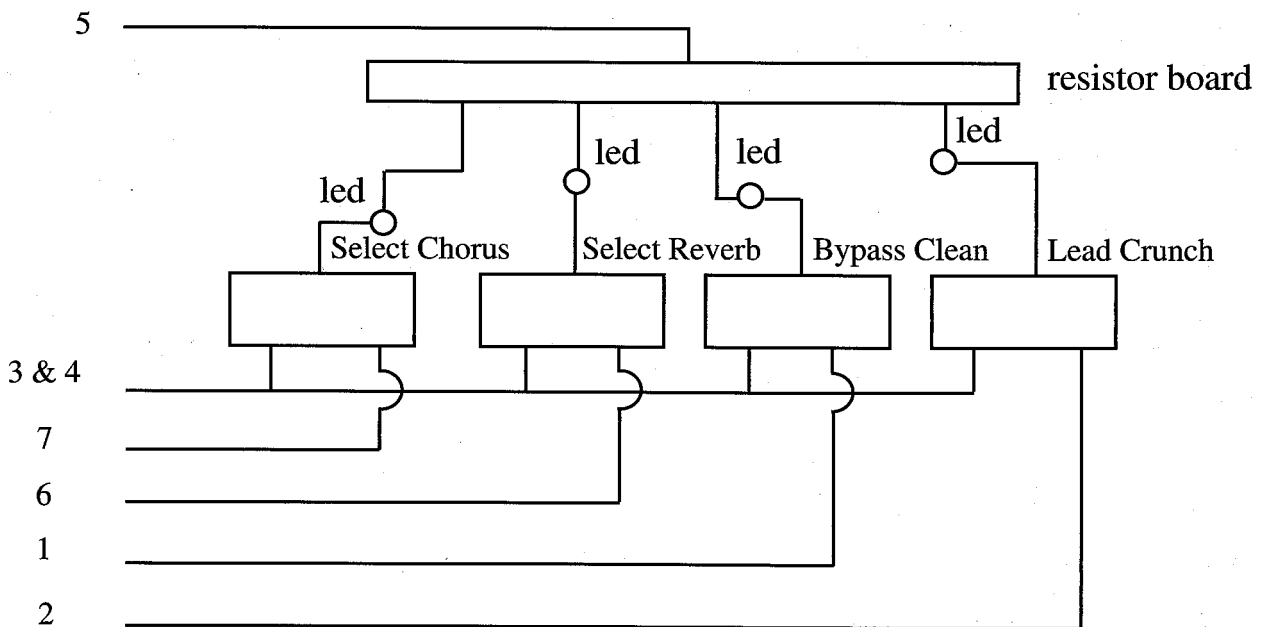

← solder side of 7 pin DIM

# HERITAGE Footswitch

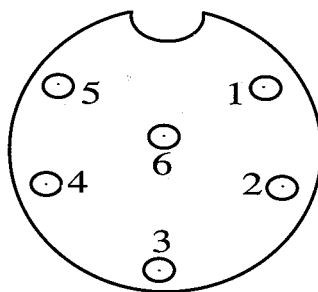
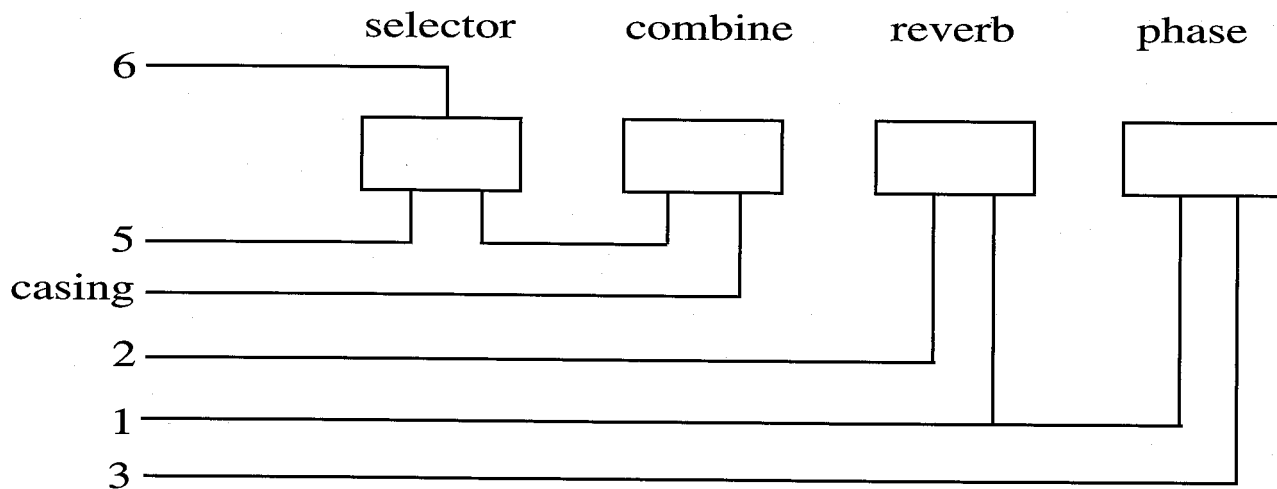

← solder side of 6 pin DIN

# Automix Footswitch (Mace 1975, Deuce "B", Deuce VT, Musician MK-3, Classic "B", Classic VT, Standard B, Roadmaster "A")

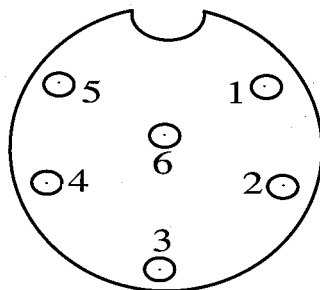
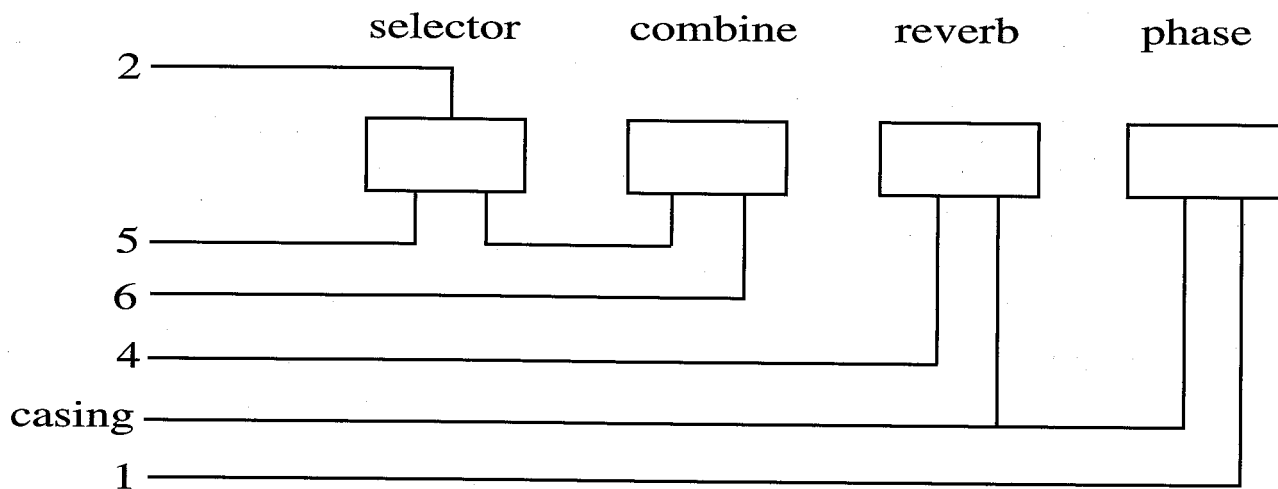

← solder side of 6 pin DIN

# Studio Chorus 70/Classic Chorus 130 Footswitch

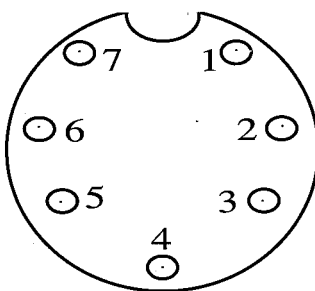
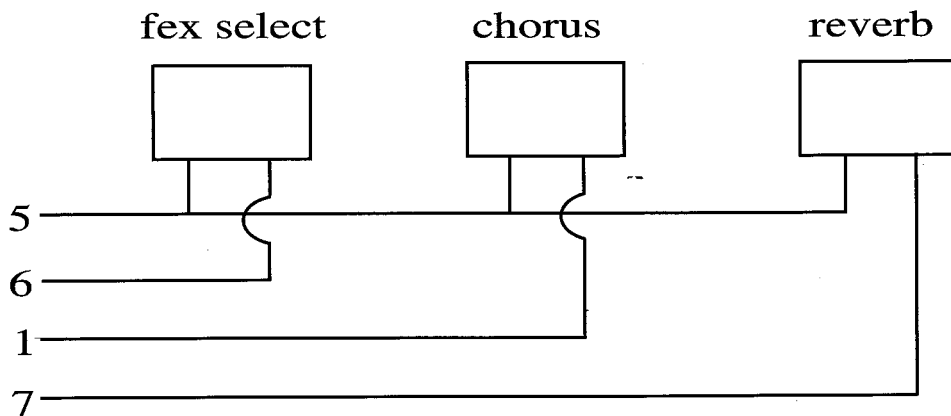

← solder side of 6 pin DIN

# RENOWN/RENOWN-400 Footswitch

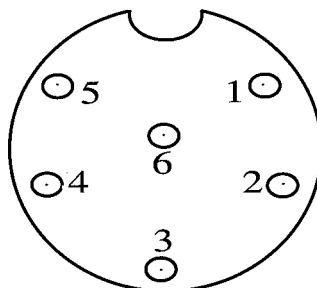
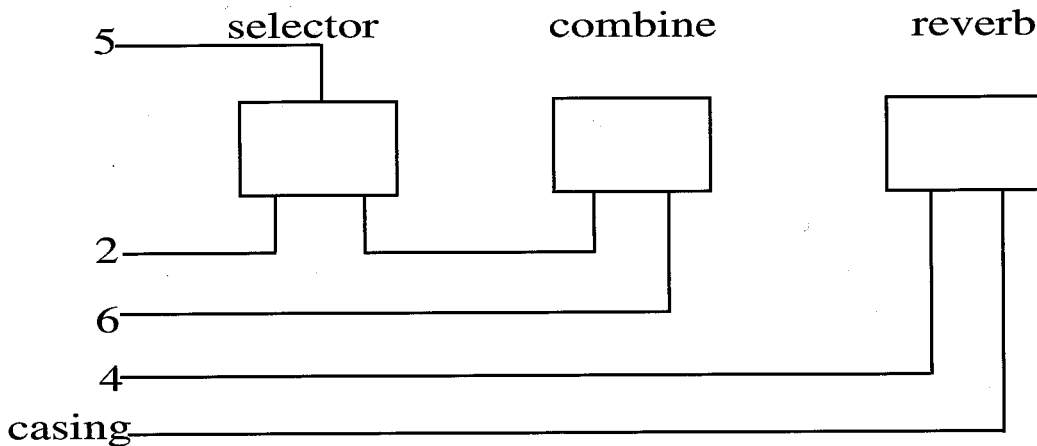

← solder side of 6 pin DIN



# ARTIST, CITATION, STANDARD MK-3

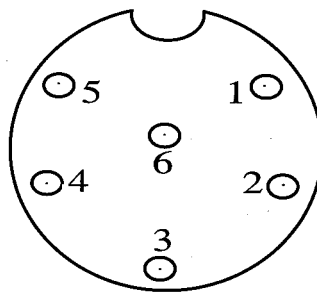
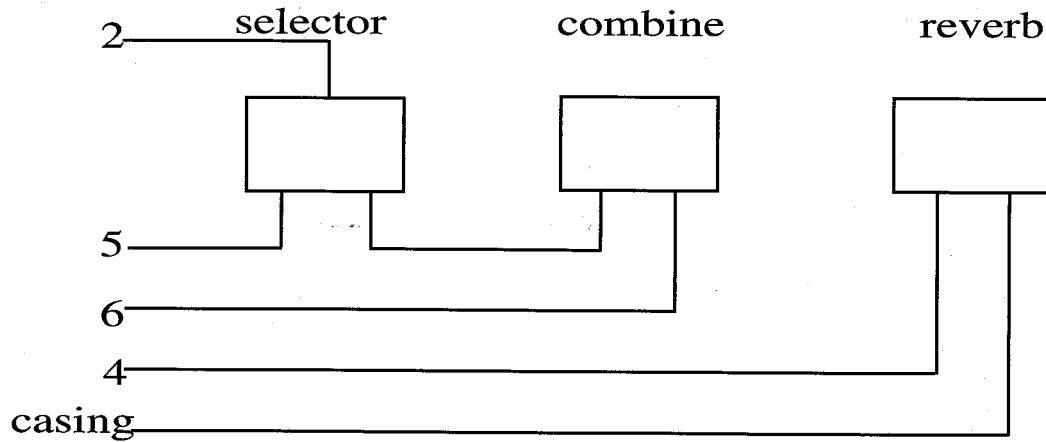

← solder side of 6 pin DIN

---

## MS VTX Footswitch

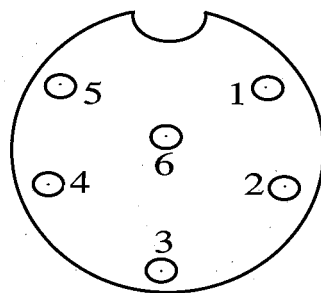
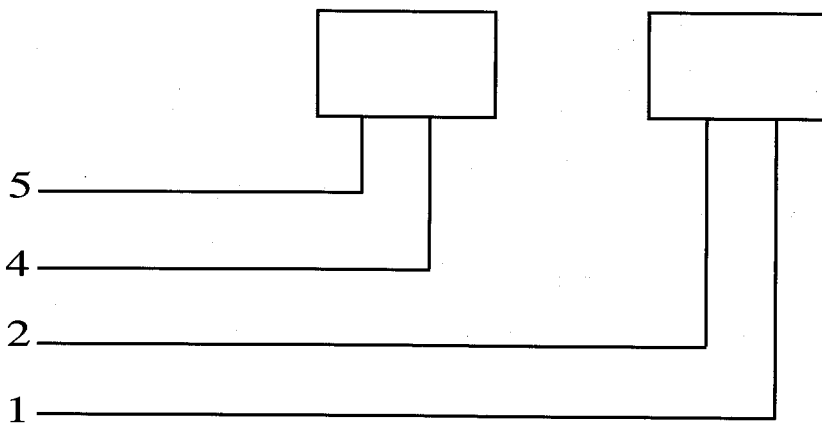

← solder side of 6 pin DIN

# Austin 400

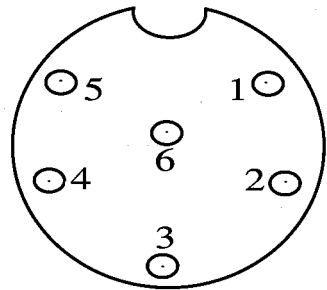
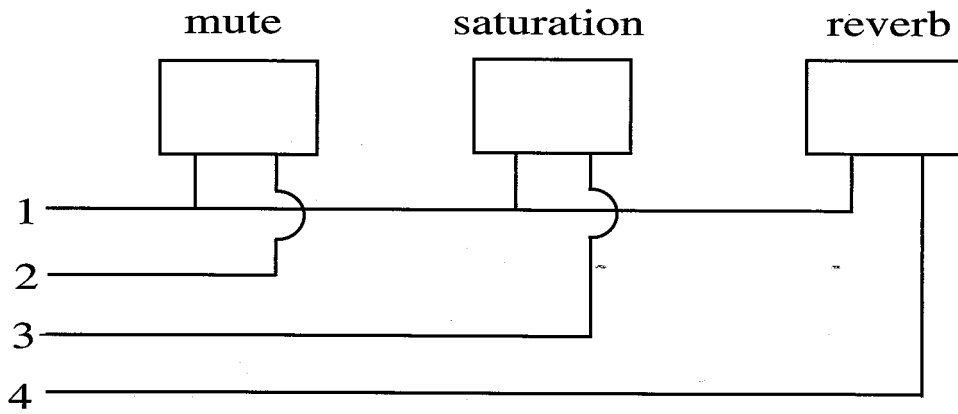

← solder side of 6 pin DIN

---

# Session 500

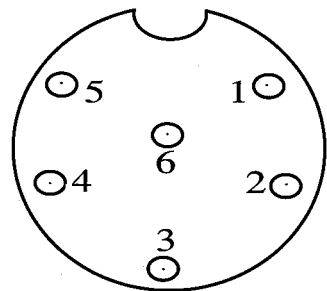
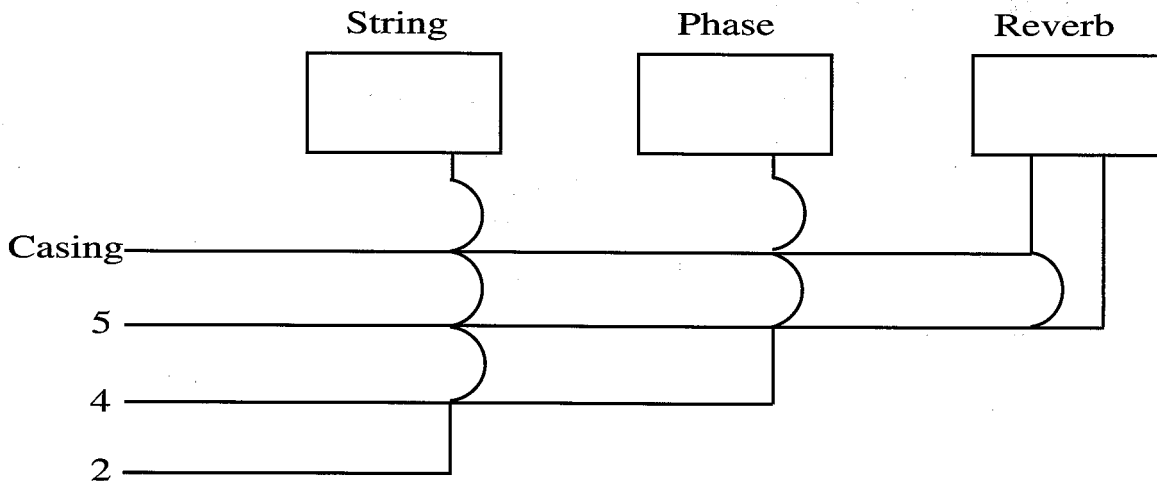

← solder side of 6 pin DIN

# MUSICIAN-B 5 BUTTON FTSW

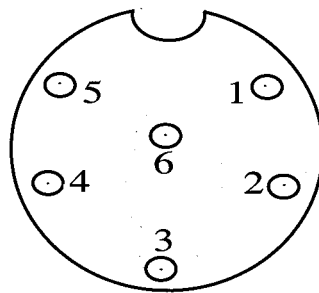
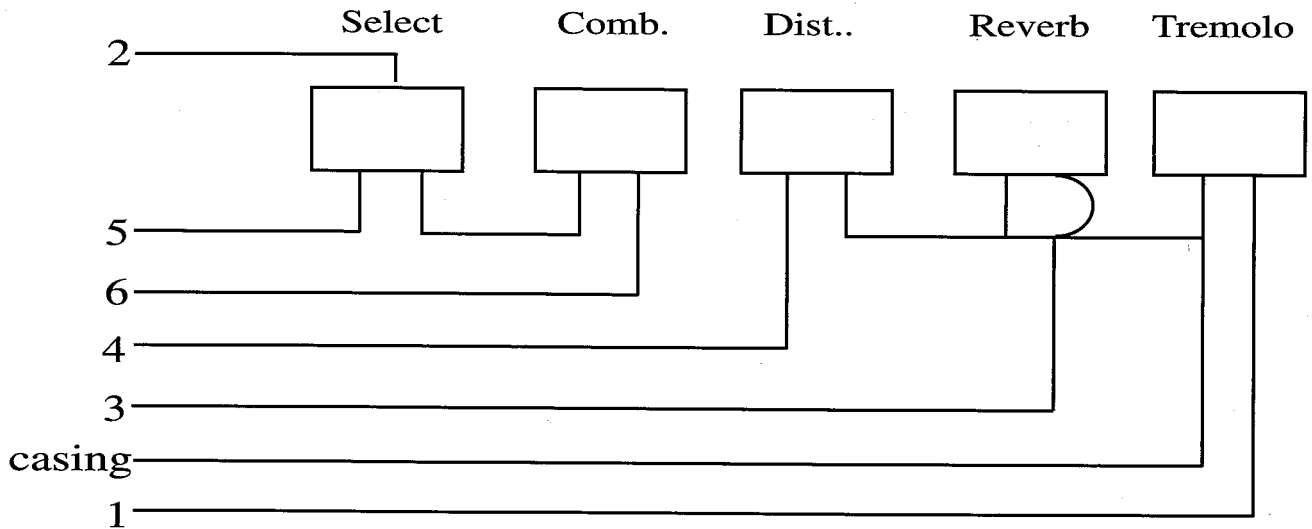

← solder side of 6 pin DIN

# SESSION-400 LTD FTSW

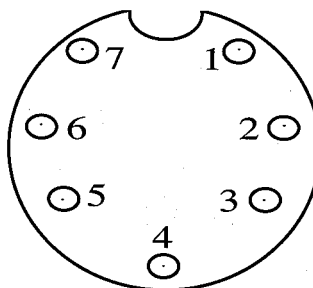
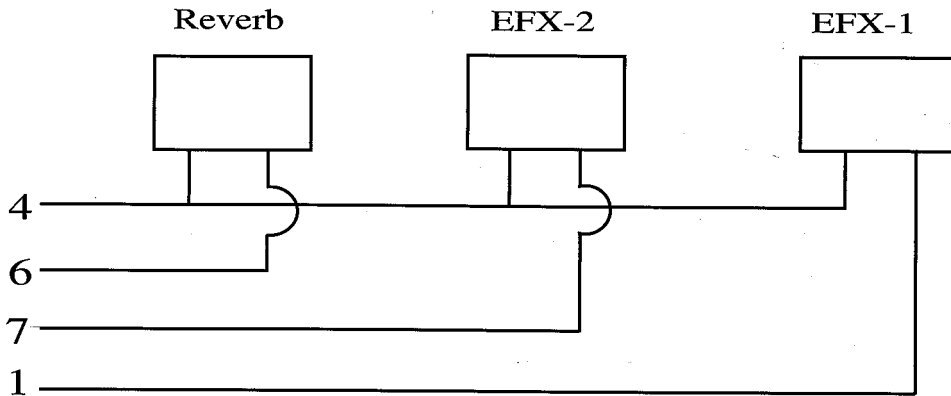

← solder side of 7 pin DIN

# TRIUMPH PAG-60/120

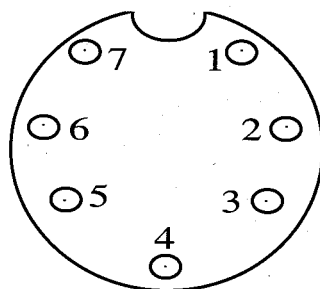
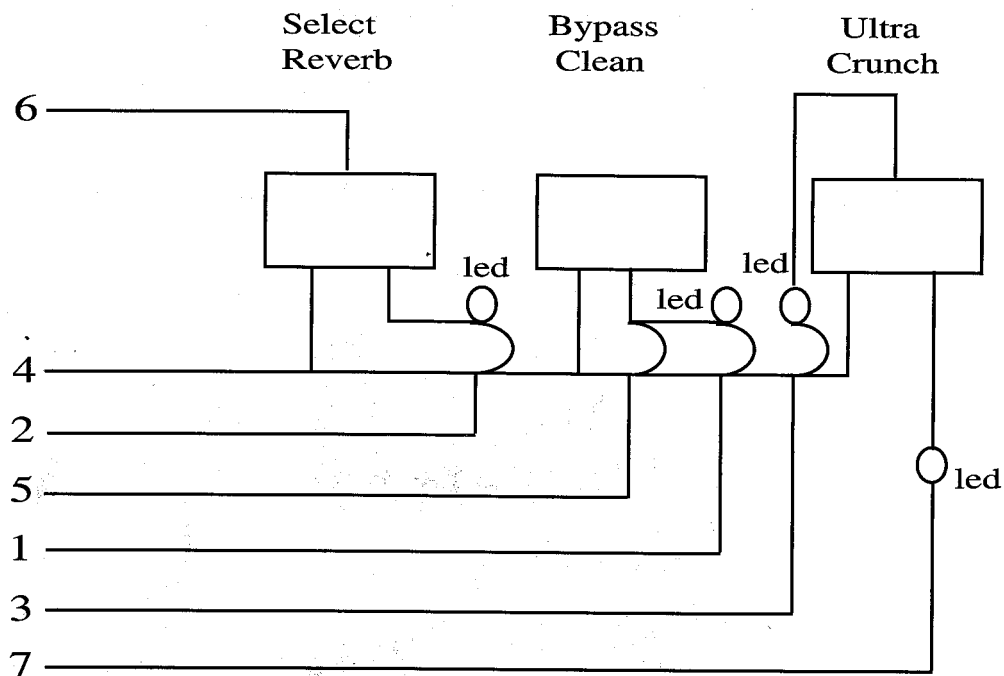

← solder side of 7 pin DIN



PEAVEY ELECTRONICS CORPORATION  
711 "A" STREET MERIDIAN, MS 39301  
(601) 483-5365 FAX (601) 486-1278