

JC - 77 3 4 5 6 7 8 9 10 11 12 13 14 15 16 17 18 19 20 21 22 23 24 25 26 27 28 29 30 31 32 33 34 35 36 37 38 39

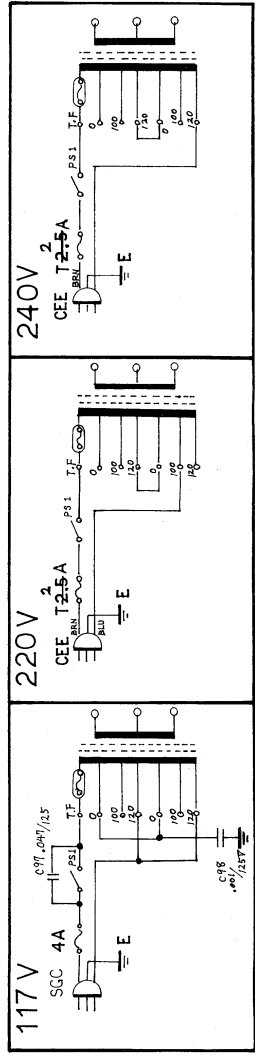
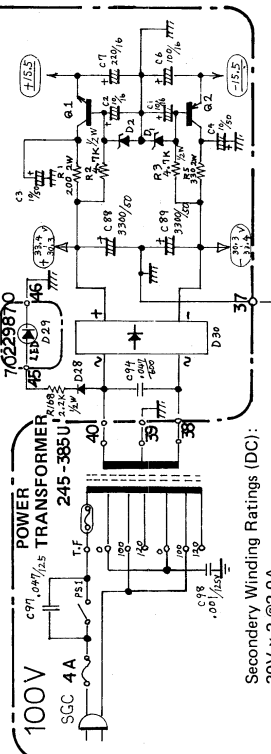
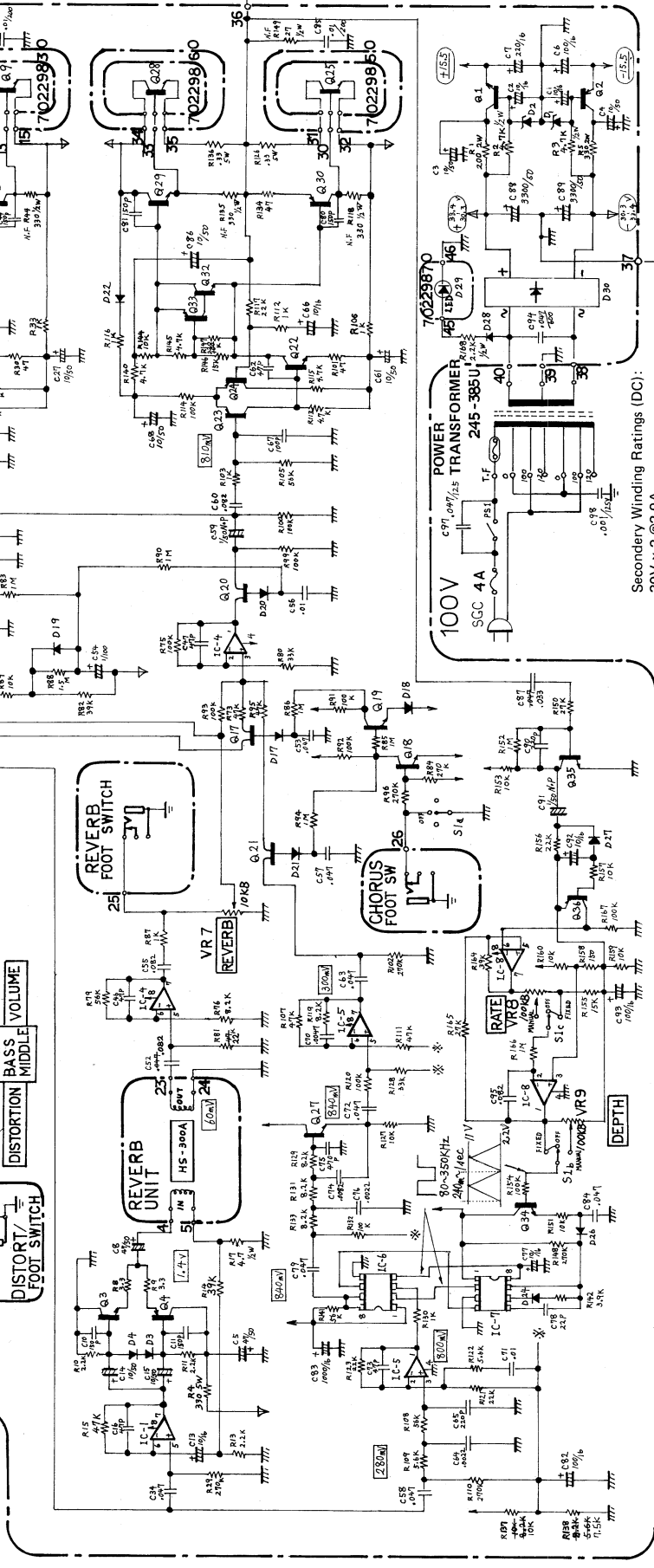
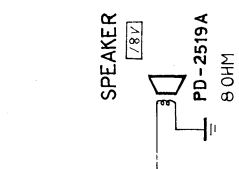
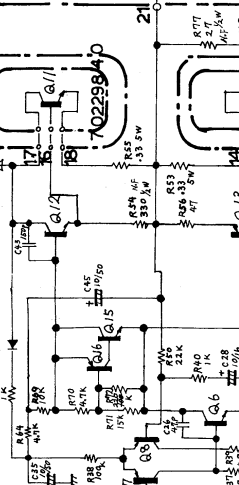
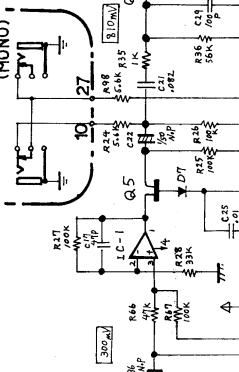
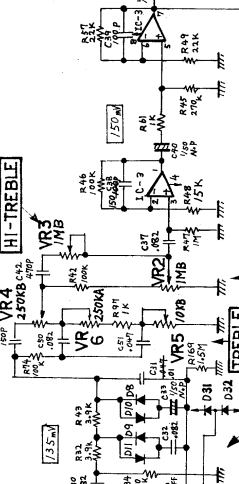
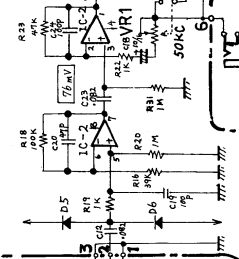
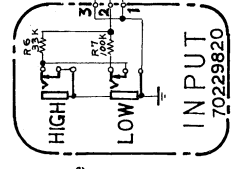

- D1, 2 ZENER RD-16
- D3-11, 17, 18, 20, 21, 1S1588 or 1S2473, DS442
- 24, 26, 27, 31, 32
- D12, 19, 22, 28
- D29 S5500 or 1N4003
- D30 GL-5AR1 (LED)
- M4C52 (BRIDGE)

*Signal Voltage (rms) Taken Under Conditions:

- Input 1kHz sine
- Equalizer BASS - FCW
- MID. - FCW
- TREBLE - FCW
- HI-TREBLE - FCW
- Distortion FCCW
- Reverb FCCW

- IC1-5, 8 ME218L, NJM4558S, LA6458S
- IC6 MN3007
- IC7 MN3101
- Q1 2SD669A
- Q2, 4, 13, 30 2SB647, 2SB649A
- Q3, 12, 29 2SD667, 2SD669A
- Q6, 22 2SD666, 2SD668, 2SC2229
- Q7, 8, 16, 23, 24, 33 2SA970GH
- Q9, 11, 25, 28 2SD716, 2SD718,
- Q15, 32 2SC2240GR
- Q36 2SC945
- Q18, 19, 27, 34, 35 2SA1015
- Q38 2SK117
- Q5, 17, 20, 21

A B C D E F G H I J K L M N O P Q R S T U