

From mic XLR input

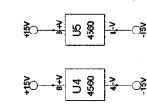

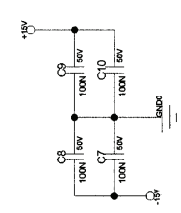
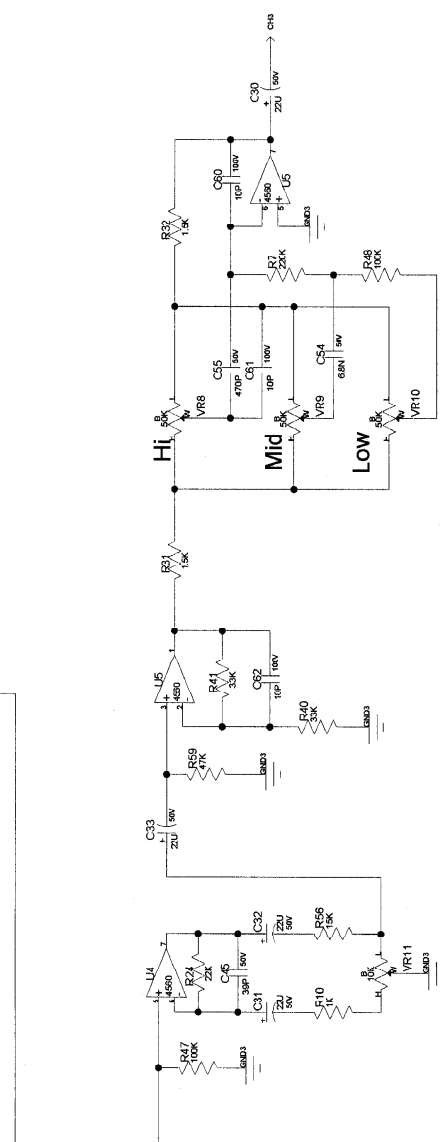
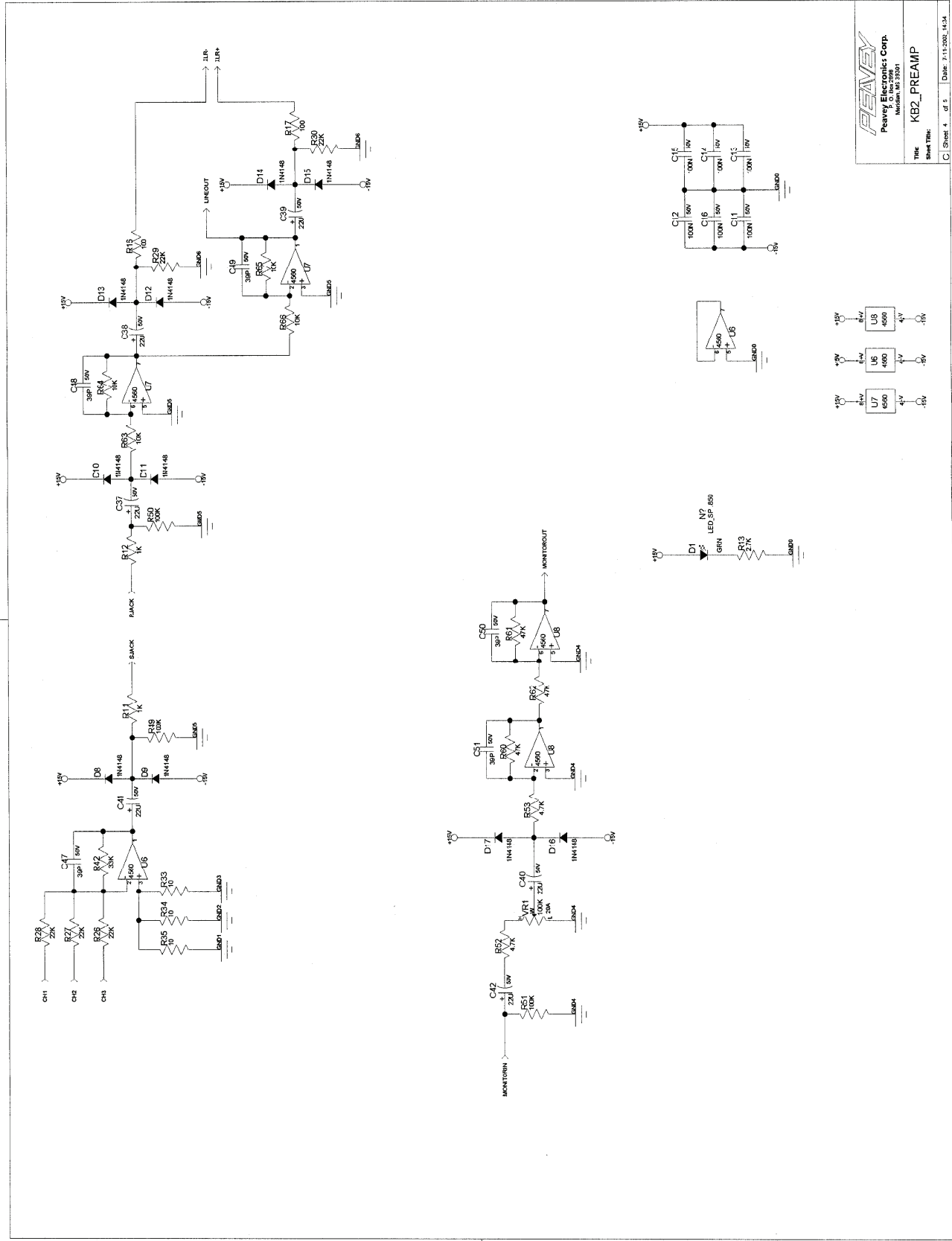

PEAVEY
 Peavey Electronics Corp.
 Midland MS 3201

Title: KB2_PREAMP
 Sheet: 4 of 5
 Date: 7-11-2009 14:54

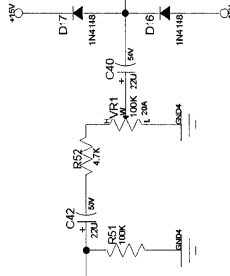
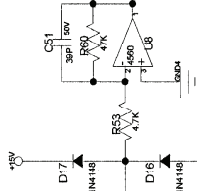
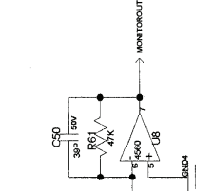
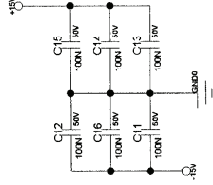
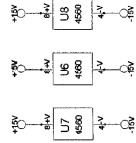

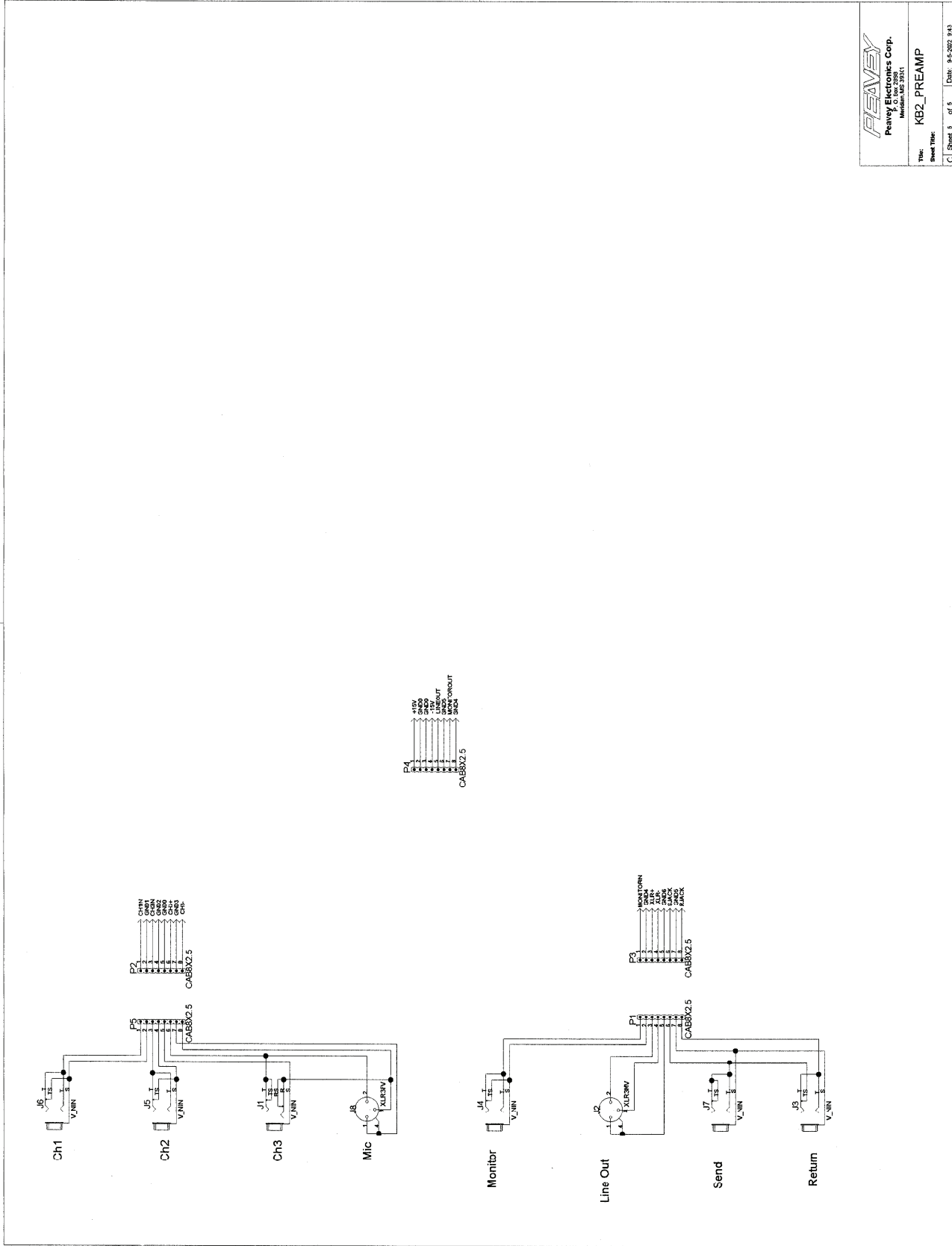

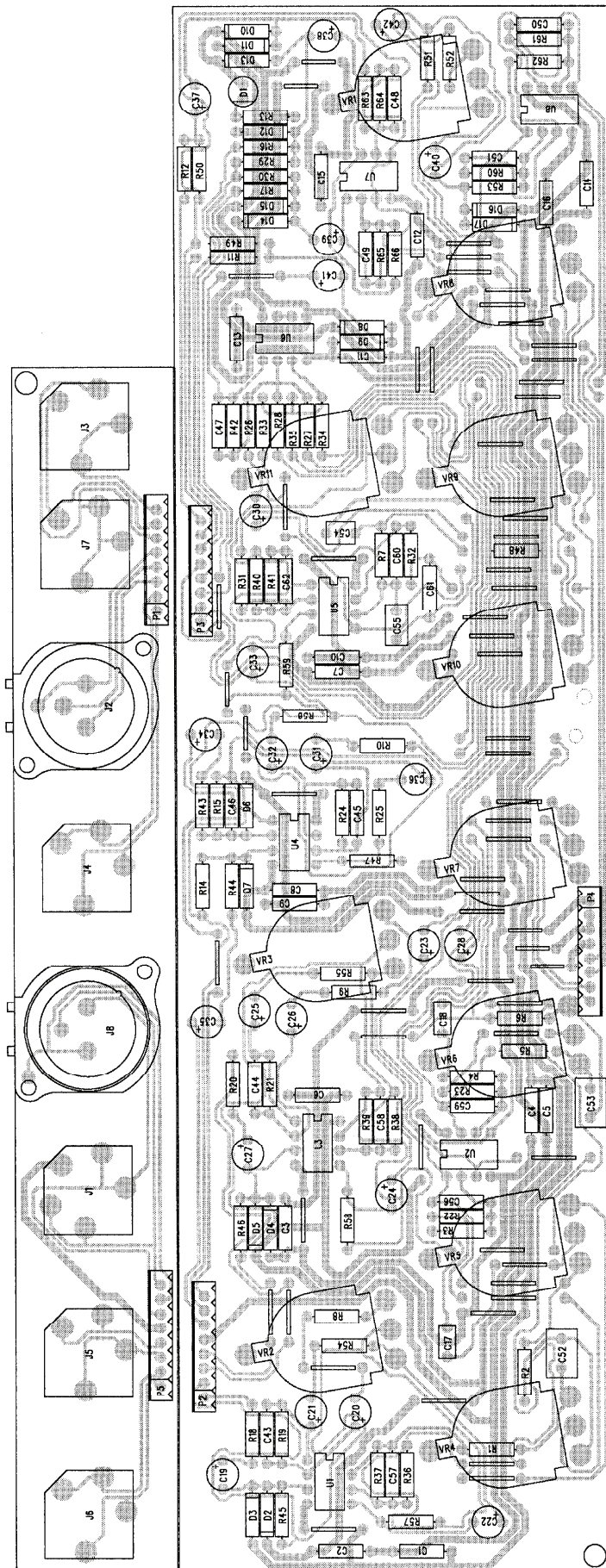

BILL OF MATERIAL REPORT

REPORT DATE/TIME: 1/6/2003 11:51:24 AM

BOARD NAME: KB 2 Preamp ASSEMBLY LEVEL NUMBER: 99060140

PROJECT NUMBER: P0100137 DESIGNER: LCG

Qty.	Part #	Description	Reference Designators
3	70240003	10 1/4W 5% CF AXL	R33 R34 R35
2	70240010	100 1/4W 5% CF AXL	R16 R17
5	70240017	1K 1/4W 5% CF AXL	R8 R9 R10 R11 R12
2	70240018	1500 1/4W 5% CF AXL	R31 R32
1	70240021	2700 1/4W 5% CF AXL	R13
2	70240023	4700 1/4W 5% CF AXL	R52 R53
3	70240027	15K 1/4W 5% CF AXL	R54 R55 R56
13	70240029	22K 1/4W 5% CF AXL	R18 R19 R20 R21 R22 R23 R24 R25 R26 R27 R28 R29 R30
7	70240030	33K 1/4W 5% CF AXL	R36 R37 R38 R39 R40 R41 R42
6	70240031	47K 1/4W 5% CF AXL	R57 R58 R59 R60 R61 R62
7	70240034	100K 1/4W 5% CF AXL	R45 R46 R47 R48 R49 R50 R51
1	70240036	220K 1/4W 5% CF AXL	R7
6	70241020	7500 1/4W 1% MF AXL	R1 R2 R3 R4 R5 R6
4	70241050	10K 1/4W 1% MF AXL	R63 R64 R65 R66
2	70241060	4990 1/4W 1% MF AXL	R43 R44
2	70241070	68.1K 1/4W 1% MF AXL	R14 R15
23	70320181	22UF 50V 20% EL RAD	C19 C20 C21 C22

							C23 C24 C25 C26 C27 C28 C30 C31 C32 C33 C34 C35 C36 C37 C38 C39 C40 C41 C42
1	70330117	6800PF	50V	5%	PE	RAD	C54
1	70330118	470PF	50V	5%	PE	RAD	C55
2	70330131	1200PF	50V	5%	PE	RAD	C17 C18
2	70330136	0.047UF	50V	5%	PE	RAD	C52 C53
7	70340050	10PF	100V	5%	NPO	AXL	C56 C57 C58 C59 C60 C61 C62
9	70340052	39PF	50V	5%	NPO	AXL	C43 C44 C45 C46 C47 C48 C49 C50 C51
16	70340100	0.1UF	50V	80-20%	Z5U	AXL	C1 C2 C3 C4 C5 C6 C7 C8 C9 C10 C11 C12 C13 C14 C15 C16
8	70414560	4560	DUAL	OPAMP	DIP8		U1 U2 U3 U4 U5 U6 U7 U8
1	70450035	GRN	LED	T-1	BULK		D1
16	70464148	1N4148	75V	10MA	DIODE		D2 D3 D4 D5 D6 D7 D8 D9 D10 D11 D12 D13 D14 D15 D16 D17
4	70600533	8C	2.5MM	WPCB	WPCB	2.5"	P1 P2 P3 P5
1	70600554	8C	2.5MM	WPCB	JST-EHR	18"	P4
3	71190336	10KB	SNGL	16MM	SPD		VR2 VR3 VR11
1	71190338	100K20A	SNGL	16MM	SPD		VR1
7	71190340	50KB	SNGL	16MM	DET	SPD	VR4 VR5 VR6 VR7 VR8 VR9 VR10
5	71466214	2	TIP	HID	JACK	NINS W/SPD	J3 J4 J5 J6 J7
1	71466217		STEREO	HID	JACK	NINS W/SPD	J1
1	71466324		MXLR	NC3MAV	A-SER	VERT	J2

1 71466325 FXLR NC3FAV A-SER VERT

J8

62 JUMPER ???

JMP1 JMP2 JMP3 JMP4
JMP5 JMP6 JMP7 JMP8
JMP9 JMP10 JMP11 JMP12
JMP13 JMP14 JMP15 JMP16
JMP17 JMP18 JMP19 JMP20
JMP21 JMP22 JMP23 JMP24
JMP25 JMP26 JMP27 JMP28
JMP29 JMP30 JMP31 JMP32
JMP33 JMP34 JMP35 JMP36
JMP37 JMP38 JMP39 JMP40
JMP41 JMP42 JMP43 JMP44
JMP45 JMP46 JMP47 JMP48
JMP49 JMP50 JMP51 JMP52
JMP53 JMP54 JMP55 JMP56
JMP57 JMP58 JMP59 JMP60
JMP61 JMP62

END OF BILL OF MATERIAL REPORT
