

A COMPARISON OF CURRENT PRODUCTION 12AX7 TUBES ©2013

Graph Interpretation

All 12AX7's have an amplification factor (μ) of 100 ("high-mu"). Ideally, every 12AX7 should yield the same gain when placed in the same circuit; however, in reality there are comparative gain differences among 12AX7's.

- This graph is based on the average gain and noise measured from different tube brands, using the same number of samples for each brand. It should not be assumed that every single 12AX7 from a specific brand will match its place on this graph.
- The gain rating is only a relative reference (e.g. a rating of "10" does not mean ten times louder than a "1").

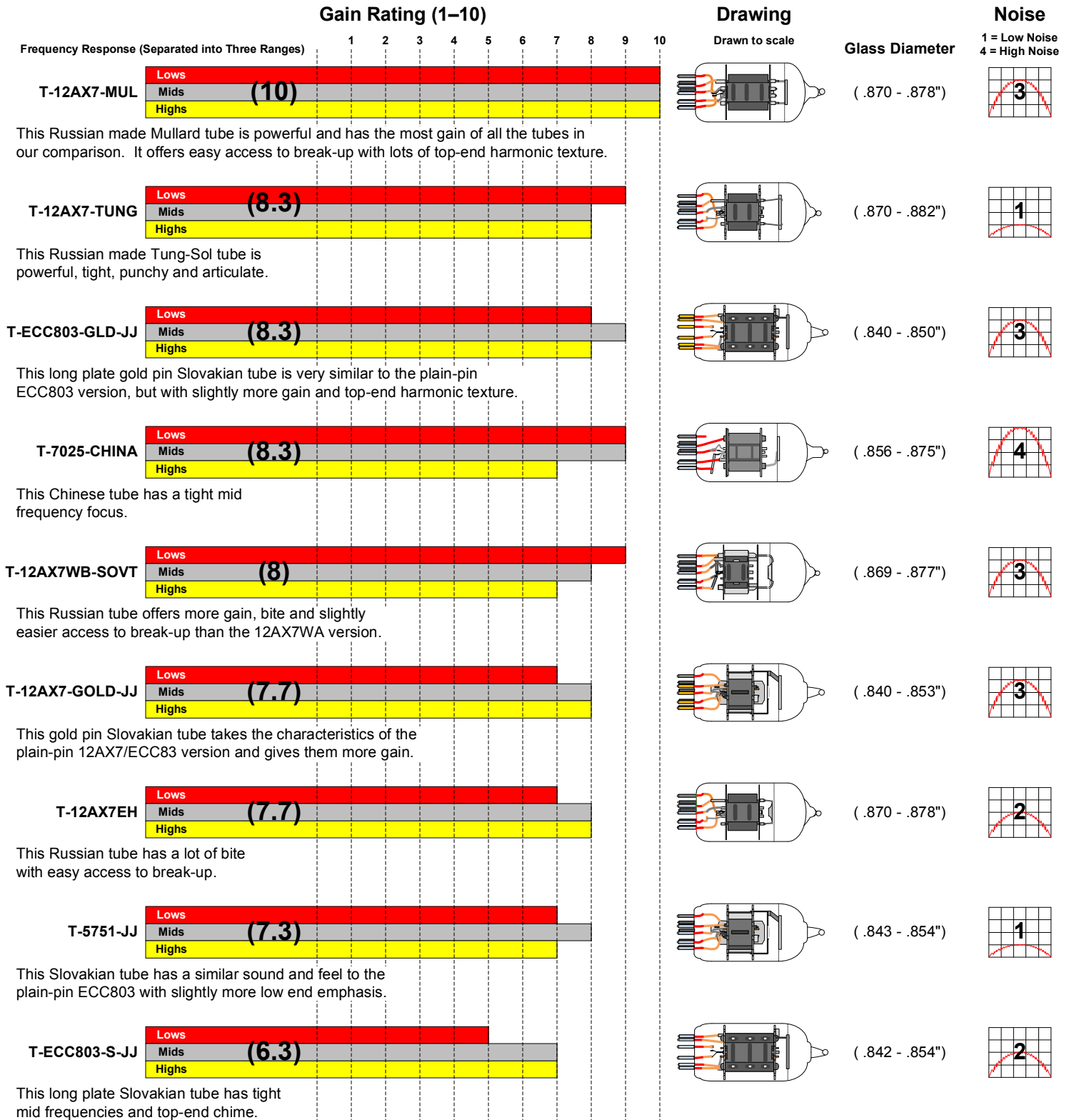

Continued on the next page

Gain Rating (1-10)

Drawing

Noise

Frequency Response (Separated into Three Ranges)

1 2 3 4 5 6 7 8 9 10

Drawn to scale

Glass Diameter

1 = Low Noise
4 = High Noise

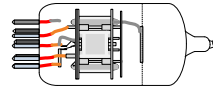

(.859 - .872")

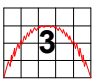

This Chinese tube from Tube Amp Doctor sounds very similar to the 7025WA version. It measured in with slightly higher gain levels, but the difference seems insignificant to the ears.

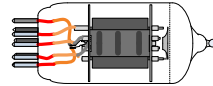
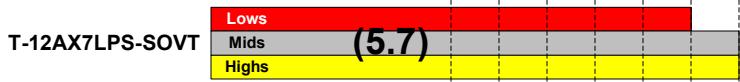

(.871 - .879")

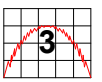

This long plate Russian tube is smooth and tight. It has warm lows and mids with a top-end that offers more presence than the 12AX7WA.

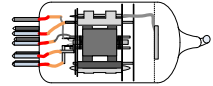
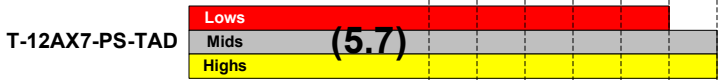

(.851 - .867")

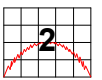

This is Tube Amp Doctor's offering of the commonly rebranded Chinese tube.

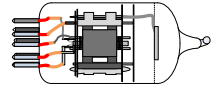

(.858 - .879")

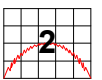

This is Ruby's offering of the commonly rebranded Chinese tube.

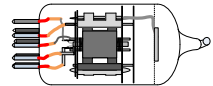
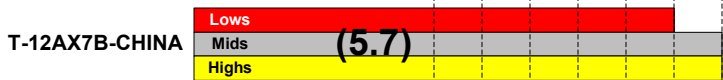

(.857 - .869")

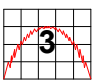

This is the "B" version of the commonly rebranded Chinese tube, straight from the source. It sounds very similar, if not identical, to the original.

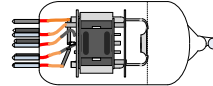

(.879 - .883")

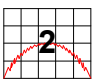

This Russian tube is full and tight with emphasis on the lows. *(The glass diameter can be on the fat side which may be a tough fit for some tube shield bases).*

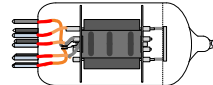

(.870 - .873")



This long plate Russian tube sounds like a slightly lower gain version of the 12AX7LPS.

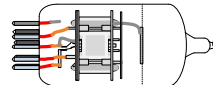

(.849 - .873")

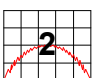

This Chinese tube from Tube Amp Doctor offers warmth with good presence and articulation.

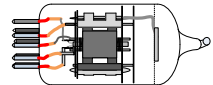

(.855 - .866")

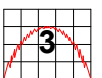

This is GrooveTubes' offering of the commonly rebranded Chinese tube.

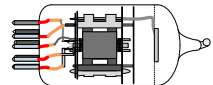

(.862 - .873")



This is the commonly rebranded Chinese tube, straight from the source.

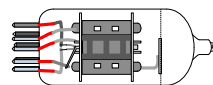
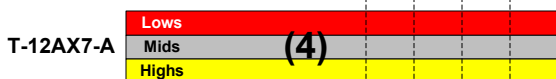

(.809 - .814")

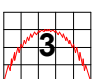

These NOS tubes are becoming scarce. This drawing is of an RCA circa 1970. We used RCA, GE and Sylvania brand tubes for our comparison.

Continued on the next page

Gain Rating (1-10)

Frequency Response (Separated into Three Ranges)



This Slovakian tube is smooth and warm. It offers easy access to break-up with lots of top-end harmonic sparkle.

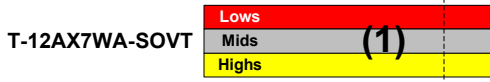

This Russian tube is smooth and tight. It offers warm lows and mids while staying conservative on the top-end texture.

Drawing

Drawn to scale

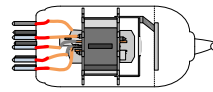

Glass Diameter

(.840 - .853")

Noise

1 = Low Noise
4 = High Noise

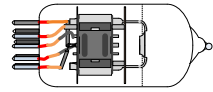
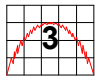

(.870 - .876")

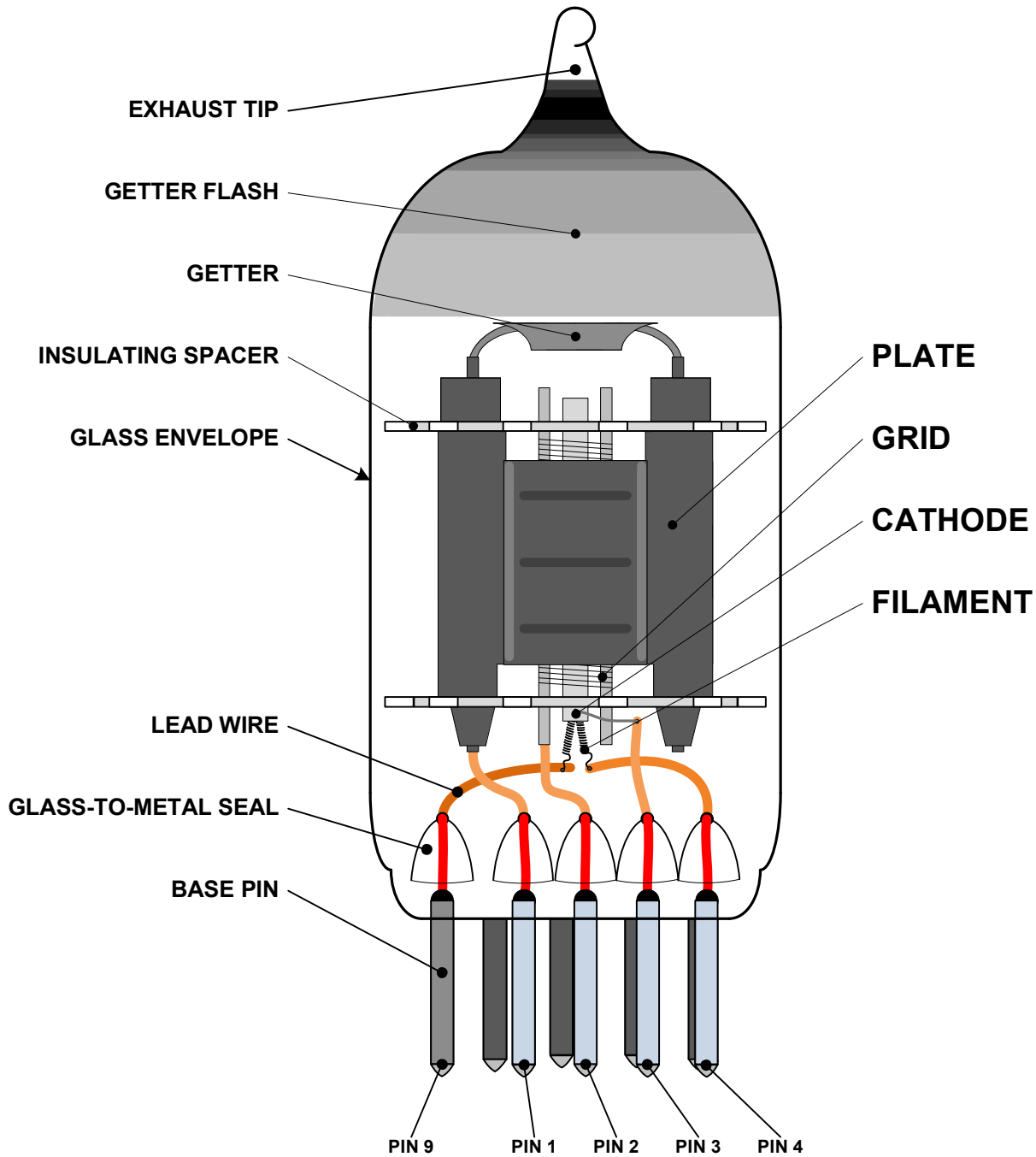
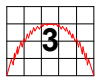

A Comparison of Current Production 12AX7 Tubes by Kurt Prange

RCA and Sylvania first introduced the 12AX7 to the world in the late 1940's. Today, it is by far the most common preamp tube used for electric guitar amplification and there is an almost overwhelming supply of current production options to choose from. The purpose of this comparison is simply to provide guitar players with a frame of reference to help in finding the best current production 12AX7 for their needs.

Also included in this comparison are direct substitutes for the 12AX7 including: ECC83, ECC803, 7025 and 5751.

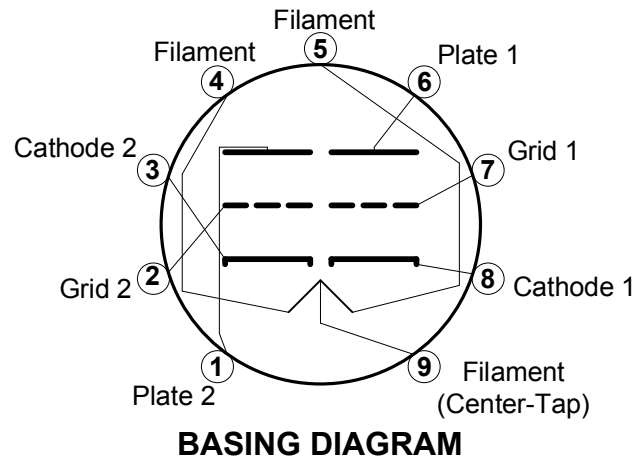
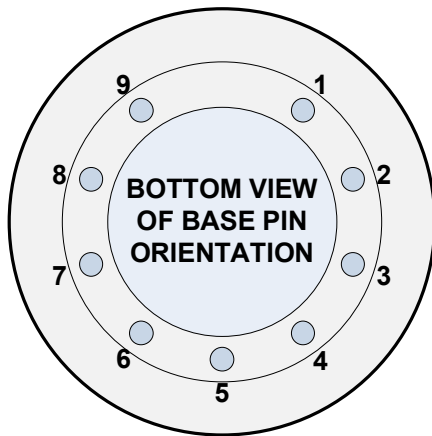

12AX7 Basics

The 12AX7 is a 9-pin miniature, high-mu, twin triode. What does that mean? The **9-pin miniature** part tells us what kind of socket the tube plugs into. It has nine thin pins arranged along the circumference of a circle with a diameter of just under half of an inch. There is a large gap between pins 1 and 9 to ensure that the tube can only be plugged in one way. The **high-mu** part is referring to the electronic specification called "amplification factor," abbreviated by the Greek letter μ (mu - pronounced myoo). This gives us a general category of amplification that the tube was designed for as compared to other preamp tube types like the "medium-mu" 12AU7. The **twin triode** part tells us that there are two identical and independent triodes contained within the one tube. A triode is the most basic tube structure that allows for signal amplification and it has three electrodes: plate, grid and cathode.

The Gain Test Setup

Each tube sample was tested in the same (Fender black face style) preamp circuit as shown in the schematic below with bass and treble set to their maximum. A frequency generator was used to measure voltage gain and plot the frequency response from 10 Hz to 18,000 Hz. From the frequency plot it could be seen that there are three extrema at about 50 Hz, 400 Hz and 4,000 Hz. These three frequencies were then used to quickly measure the low, mid and high frequency voltage gain on the same number of samples for each tube in our comparison. The average from each tube's samples was then calculated and used for comparison. The smallest average low frequency gain tube was used as the reference for a gain of "1" and the largest average low frequency gain tube was used as the reference for a gain of "10". This gain reference method was then repeated for both the mid and high frequency averages.

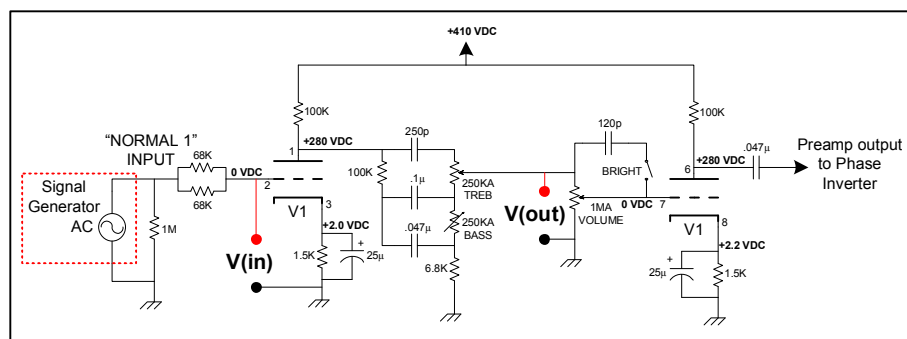

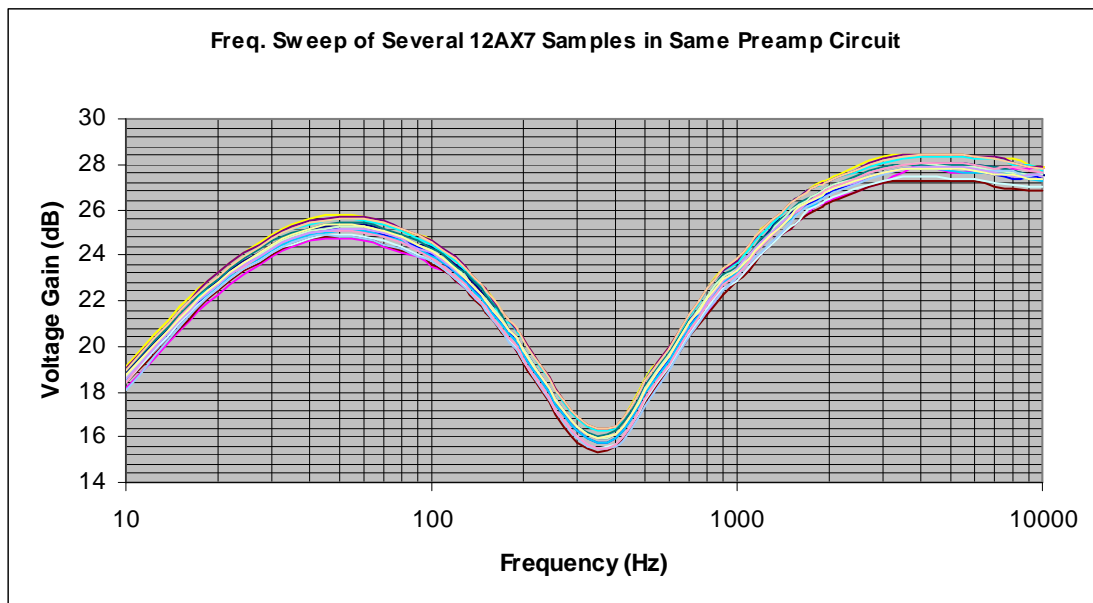

The Noise Test Setup

Each tube sample was again tested in the same preamp circuit and an oscilloscope was connected to the amplifier output to monitor the amplitude of the voltage spike produced by tapping on the tube's glass envelope. The average voltage spike from each tube's samples was then calculated and used for comparison.

The Listening Test Setup

A custom 12AX7 switching box was constructed to allow for a quick switch comparison of six tubes at a time while plugged into the V1 socket of a Marshall JCM800 2203 guitar amplifier. A separate filament transformer was used on the switching box to simultaneously heat all six comparison tube filaments without overheating the amplifier's power transformer. A shielded cable was constructed to plug into the amplifier's V1 socket and transfer its pin 1, 2, 3, 6, 7 and 8 connections to one tube socket at a time in the switching box. Listening tests were then conducted while playing guitar and switching between the tubes at various amplifier control settings to come up with tonal descriptions for each tube.

Kurt Prange (BSEE) is the Sales Engineer for Amplified Parts (www.amplifiedparts.com) in Tempe, Arizona, United States. Kurt began playing guitar at the age of nine in Kalamazoo, Michigan. He is a guitar DIY'er and tube amp designer who enjoys helping other musicians along in the endless pursuit of tone.