

BLUES JUNIOR

SERVICE MANUAL



CONTENTS:

- Notices
- Specifications
- Theory of operation
- Parts lists:
 - PCB assembly
 - Chassis assembly
 - Cabinet assembly
 - Miscellaneous
- Schematics/Service diagram

BLUES JUNIOR

SERVICE MANUAL

NOVEMBER 1995

IMPORTANT NOTICE:

The information contained herein is CONFIDENTIAL and PROPRIETARY to Fender Musical Instruments Corp. It is disclosed solely for use by qualified technicians for purposes of equipment maintenance and service. It is not to be disclosed to others without the expressed permission of Fender Musical Instruments Co. All specifications subject to change without notice.

For warranty repair service, only Fender specified part numbers are to be used. It is recommended they also be used for post-warranty maintenance and repair.

Parts marked with an asterick (*) indicate the required use of that specific part. This is necessary for RELIABILITY and SAFETY requirements. **DO NOT USE A SUBSTITUTE!**

A coded naming convention is used in the description of certain parts. The codes and what they mean are as follows:

CAPACITOR CODES

CAP AE = Aluminum Electrolytic
CAP CA = Ceramic Axial
CAP CD = Ceramic Disk
CAP MPF = Metalized Polyester Film
CAP MY = Mylar
CAP PFF = Polyester Film/Foil

RESISTOR CODES

RES CC = Carbon Comp
RES CF = Carbon Film
RES FP = Flame Proof
RES MF = Metal Film
RES WW = Wire Wound

HARDWARE CODES

BLX = Black Oxide
CR = Chrome Plated
HWH = Hex Washer Head
M = Machine Screw
NI = Nickel Plated
OHP = Oval Head Phillips
PB = Particle Board
PHP = Pan Head Phillips
PHPS = Pan Head Phillips Sems
SMA = Sheet Metal "A" Point
SMB = Sheet Metal "B" Point
SS = Stainless Steel
TF = Thread Forming
ZI = Zinc Plated

BLUES JUNIOR

SPECIFICATIONS

Type	PR 295
Input impedance:	1M ohm
Power output:	15 Watts R.M.S. @ 5% T.H.D
Rated load impedance:	8 Ohms
Speaker compliment	One 8 ohm 12" Eminence, replica of Jenson P-10
Dimensions:	
Height:	16 inches (41 cm)
Width:	18 inches (46 cm)
Depth:	9-13/16 inches (25 cm)
Weight:	31 lbs. (14 kg)

THEORY OF OPERATION

J1 is a high-sensitivity input with an input impedance of about $1M\Omega$. V1B is the first gain stage which also contains the "FAT" switch. The FAT feature is activated by grounding the node between bypass capacitor C3 and R9. Via the FAT switch (S1) or the optional footswitch, the junction of R52 and R54 can be grounded. With zero volts applied to the gate of Q1, the JFET will essentially ground C3, activating the FAT feature.

The output of V1B couples to the VOLUME control (R7). The VOLUME control is actually a preamp overdrive control that adjusts the level of distortion. C2 attenuates high frequencies and C1 attenuates low frequencies at high distortion settings. This takes the edge off the distortion and prevents the speaker from flapping. V1A provides a gain of about 40, and drives the tone control circuitry. After the tone controls, the signal is fed to V2B, which drives the MASTER volume control (R41). From the MASTER volume, the signal splits to feed the power amplifier and the Reverb.

U1A makes up a typical solid-state reverb drive circuit. U1B is the reverb recovery or sense circuit, which drives the REVERB control (R51). The reverb signal is summed with the dry signal at C6, which couples to the input of the Phase Inverter (V3).

The output tubes (6BQ5/EL84) are arranged in a push-pull configuration that will produce fifteen (15) watts R.M.S. into eight (8) ohms @ 5% THD, 1kHz.

The output bias is derived from the -15Vdc supply. The voltage divider at R31 & R37 determines the bias voltage (-10.7 Vdc). C14 filters the ripple to 1mV or less.

BLUES JUNIOR PARTS LIST

PRINTED CIRCUIT BOARD ASSEMBLY

QTY	PART #	DESCRIPTION	REFERENCE DESIGNATION
1	049306001	PCB ASSY BLUES JUNIOR ALL V	(STUFFED)
1	028104000	BUTTON PUSH SWITCH BLACK	(@ S1)
2	047093000	CABLE 6 CKT 3.2"	CJ1,3
3	029533000	CABLE JMPR 22GA 4 CKT 3.2"	CJ2,4,5
1	028577000	CABLE REVERB 30"	(@ P1,2,3,4)
1	038689001	CAP AE AX .47μF 100V	C23
3	009512001	CAP AE AX 22μF 25V 20%	C3,4,21
3	024819000	CAP AE AX 22μF 500V	C10,17,18
1	041589000	CAP AE AX 47μF 500V 20%	C15
1	028474000	CAP AE RDL 100μF 25V 20%	C14
2	028479000	CAP AE RDL 220μF 25V 20%	C29,30
2	028489000	CAP AE RDL 470μF 50V 20%	C27,28
1	039255001	CAP CA 10PF 100V LL	C24
1	020909000	CAP CD 47PF 1000V 10%	C33
1	069724000	CAP CD 100PF 1000V 10% C&F	C2
1	020917000	CAP CD 250PF 1000V 10%	C25
1	020867000	CAP CD 330PF 1000V 10%	C20
1	017620000	CAP CD 1500PF 1000V 10%	C35
1	039265001	CAP CA 2200PF 100V LL	C22
2	026202000	CAP PFF .0022μF 600V	C1,16
1	033581000	CAP PFF RDL .0033μF 100V 10%	C26
1	033588000	CAP PFF RDL .01μF 100V 10%	C31
2	024823000	CAP MPF RDL .01μF 400V 10%	C6,34
1	036234000	CAP PFF RDL .015μF 100V 10%	C12
4	024833000	CAP MPF RDL .022μF 400V 10%	C8,9,11,13
1	024839000	CAP MPF .033μF 400V	C19
2	024853000	CAP MPF RDL .1μF 250V 10%	C5,7
1	024855000	CAP MPF RDL .1μF 630V 10%	C32
1	049402000	CONTROL 25K B SNAPIN	R29
2	034719000	CONTROL 50KB SNAP IN	R41,51
1	041913000	CONTROL SNAPIN 250K 10A	R8
1	040985000	CONTROL SNAPIN 250K B	R28
1	049401000	CONTROL 1M 10A	R7
2	064089001	DIODE 1N4003 LL	CR5,7
4	026730001	DIODE 1N4006 800V LL	CR1,2,3,4
2	006260001	DIODE 1N4448 SIGNAL LL	CR6,12
2	029690001	DIODE HV 3KV 200MA LL	CR10,11
2	009165001	DIODE ZEN 1N4744A 15V 1W 5%	CR8,9
16	025802000	FSTN TAB MALE .250X.032 PCB MT	CP1-13,16-18
2	031041000	FSTN TAB ML RTANG PCB .25X.032	CP14,15
2	025996000	FUSE CLIP PCB .250 & 5MM FUSE	XF1
1	048827	FUSE QA 1-1/4X1/4 250V 2A	F1 (100V/120V ONLY)
1	020789	FUSE QA 20mmX5mm 250V 1 AMP	F1 (230/240V EXPORT ONLY)
1	016795	IC DUAL OP AMP TLO72	U1
1	030771	JACK 1/4 PCB 2/CD SCC	J2 (SPEAKER JACK)
1	027674	JACK 1/4 PCB 2/CD SCC INSL	J3 (FOOTSWITCH JACK)
1	037036	JACK PHONE PCB MONO CA PREMIUM	J1 (INPUT JACK)
26	020888001	JUMPER WIRE 22GA .5"	W1-26
1	048332	LED RED PNL MT 7"	LD1
1	049305	PCB FAB BLUES JUNIOR	(RAW BOARD)
1	024947001	RES CF 1/4W 5% 47Ω LL	R45
1	024964001	RES CF 1/4W 5% 280Ω LL	R15
5	024969001	RES CF 1/4W 5% 1.5K LL	R4,11,20,23,38
1	029005001	RES CF 1/4W 5% 2K LL	R49

BLUES JUNIOR

PRINTED CIRCUIT BOARD ASSEMBLY (CONT)

QTY	PART #	DESCRIPTION	REFERENCE DESIGNATION
2	024977001	RES CF 1/4W 5% 4.7K LL	R16,46
1	025942001	RES CF 1/4W 5% 7.5K LL	R26
1	026510001	RES CF 1/4W 5% 9.1K LL	R18
3	024981001	RES CF 1/4W 5% 10K LL	R1,30,48
3	024987001	RES CF 1/4W 5% 22K LL	R31,52,54
2	024989001	RES CF 1/4W 5% 33K LL	R13,37
1	028153001	RES CF 1/4W 5% 75K LL	R27
2	024997001	RES CF 1/4W 5% 100K LL	R6,9
1	024998001	RES CF 1/4W 5% 120K LL	R44
1	028955001	RES CF 1/4W 5% 130K LL	R5
3	025059001	RES CF 1/4W 5% 220K LL	R21,22,42
1	025061001	RES CF 1/4W 5% 330K LL	R50
1	025828001	RES CF 1/4W 5% 430K LL	R40
2	025065001	RES CF 1/4W 5% 470K LL	R47,56
1	029618001	RES CF 1/4W 5% 910K LL	R43
4	025069001	RES CF 1/4W 5% 1M LL	R2,12,14,53
2	041741001	RES MOX FP 1/2W 5% 47Ω	R35,36
2	028580001	RES MOX FP 1/2W 5% 100Ω	R24,25
1	025829001	RES CF 1/2W 5% 150Ω LL	R34
1	031065001	RES CF 1/2W 5% 91K LL	R17
4	025116001	RES CF 1/2W 5% 100K LL	R3,10,19,39
2	031067001	RES FILM 1W 5% 750Ω LL	R57,58
2	027349001	RES FILM 1W 5% 10K LL	R33,55
1	041258	RES CF 2W 5% 2.2K	R32
1	028091	SWITCH PUSH SLFLK SHORT STROKE	S1
5	029167	TUBE SOCKET 9 PIN PCB MOUNT	XV1-5
1	014689	XSTR N-CH JFET J111 TO-92	Q1

CHASSIS ASSEMBLY

QTY	PART #	DESCRIPTION	REFERENCE DESIGNATION
1	049307	CHS ASSY BLUES JUNIOR 120V	(COMPLETE CHASSIS)
1	047560	BRACKET TUBE RETAINER PRO. JR.	(@ V4,5)
2	018022	BUSHING SNAP 5/16X17/32 BLK	(@ OUTPUT TRANSFORMER)
1	026116	BUSHING SR .500X.063X7/16 BLK	(@ REVERB CABLE)
1	026038	BUSHING SR. .625X.062X37/64BLK	(@ POWER CABLE)
1	010401	BUSHING SR .625X.125X37/64 WHT	(@ 230V & U.K. POWER CABLE)
1	026541	CABLE ASSY PWR W/.250 TAB 120V	(POWER CABLE 120V ONLY)
1	048463	CABLE ASSY PWR .250 TAB 100V	(POWER CABLE 100V ONLY)
1	033331	CABLE ASSY PWR 220/240V	(POWER CABLE 230V ONLY)
1	038602	CABLE ASSY PWR AUST .250 TAB	(PWR CABLE AUSTRALIA 240V)
1	040993	CABLE ASSY PWR 5A U.K..250 TAB	(P CABLE UNITED KINGDOM 240V)
1	049101	CHS BLUES JUNIOR	(RAW CHASSIS)
6	041710	KNOB POINTED PUSH ON BLK	
1	027288	LENS LED RED	(@ LD1)
2	016352	NUT HEX 3/8-32X3/32 TK NI	(@ SPEAKER & FOOTSWITCH JACK)
9	097360	NUT HEX 4-40 EX LOCK	(TUBE PCB MOUNT)
4	022004	NUT KEPS #8-32 ZINC	(POWER TRANSFORMER MOUNT)
1	049102	PANEL FRONT BLUES JUNIOR	(CHROME PANEL UNDER KNOBS)
1	049300	PANEL REAR BLUES JUNIOR	(@ BACK OF CABINET)
9	031188	SCRW M 4-40X1/4 PHPS ZI W/WSHR	(TUBE PCB TO CHASSIS MOUNT)
4	038900	SCRW TF 6-32X1/4 PHP ZI	(GND LUG & OUTPUT XFMR MOUNT)
7	037353	SCRW TF 6-32X3/4 PHP ZI	MAIN PCB TO CHASSIS MOUNT)
2	039371	SPRING, EXTENSION 1.81X.15"	(@ V4,5)
9	038519	STANDOFF M/F 4-40 X 1/4L	(TUBE PCB TO CHASSIS MOUNT)
7	047040	STANDOFF NYLON PCB SNAPIN 1/2"	(PCB MOUNT)

BLUES JUNIOR CHASSIS ASSEMBLY (CONT)

QTY	PART #	DESCRIPTION	REFERENCE DESIGNATION
1	036570	SWITCH TOGGLE DPST W/NUTS	S1 (POWER SWITCH)
3	013341	TUBE 7025/12AX7WA RUSSIAN MADE	V1,2,3
2	041255	TUBE 6BQ5/EL84	V4,5
2	990430092	WASHER FLAT .482X.709 NI	(@ INPUT JACK & POWER SWITCH)
2	990430010	WASHER LCK INTL 3/8X.681X.032	(@ SPEAKER & FOOTSWITCH JACK)
1	049969	XFMR OUTPUT 15W	T1
1	049967	XFMR PWR BLUES JUNIOR 120V	T2 (120V ONLY)
1	049968	XFMR PWR BLUES JUNIOR EXPORT	T2 (100V,115V,230V,240V)

CABINET ASSEMBLY

QTY	PART #	DESCRIPTION	REFERENCE DESIGNATION
1	049103	CAB ASSY BLUES JR TWEED	(COMPLETE CABINET)
1	049103020	BACK ASSY BLUES JR TWEED	(BACKBOARD)
1	038566	CABLE ASSY SPKR RT ANG 13-1/2	(SPEAKER CABLE)
1	022491	CLAMP CABLE NYL SCREW MNT 5/16	
.3360	036131	CLOTH GRILLE VINTAGE TYPE	
4	029821	EYELET RFLNGD .215 OD X.315 L	(REVERB PAN MOUNT)
4	0415490	GLIDE PRESS-IN .75 DIA	
1	049103010	GRILLE BAFFLE ASSY BLUES JR	(COMPLETE GRILLE)
1	048534	HANDLE 8 3/4" LEATHER BROWN	
2	036478	HANDLE CAP NI	
1	041929	NAMEPLATE FENDER TWEED AMPS	
4	069393	NUT 6-32 HEX EXT LOCK	(GRILLE MOUNT)
4	021972	NUT T 10-32X3/4 STR 3 PRNG BLX	(SPEAKER MOUNT)
4	064162	NUT T 8-32X1/2 STR 3 PRNG BLX	(HANDLE MOUNT)
.0010	036650	PIN ESCUTCHEON #18X3/8 NI	(NAMEPLATE MOUNT)
1	028055	REVERB UNIT 800 OHM 8EB2C1B DN	(PAN)
4	026577	SCREW M 10-32X1 PHP BLX	(SPEAKER MOUNT)
4	036619	SCREW M 10-32X1-1/2 THP NI	(CHASSIS MOUNT)
6	015990	SCREW M 10-32X3/4 THP NI	(BACKBOARD MOUNT)
4	036618	SCREW M 6-32X1-1/2 OHP BRONZ	(GRILLE MOUNT)
4	026419	SCREW M 8-32X1 PHP STL NI	(HANDLE MOUNT)
5	029828	SCREW PB 8X3/4 PHP ZI	(REVERB PAN & CABLE CLAMP MNT)
1	037617	SPEAKER 12" 8 OHM 50 WATTS	
1.036	036343	TOLEX TWEED	
4	022327	WASHER FLAT 8X7/16 NI	

MISCELLANEOUS

QTY	PART #	DESCRIPTION	REFERENCE DESIGNATION
1	049312	MANUAL OWNERS BLUES JUNIOR	
1	049302	SCHEM REDU W/SCV DIA BLS JR	

0049302000

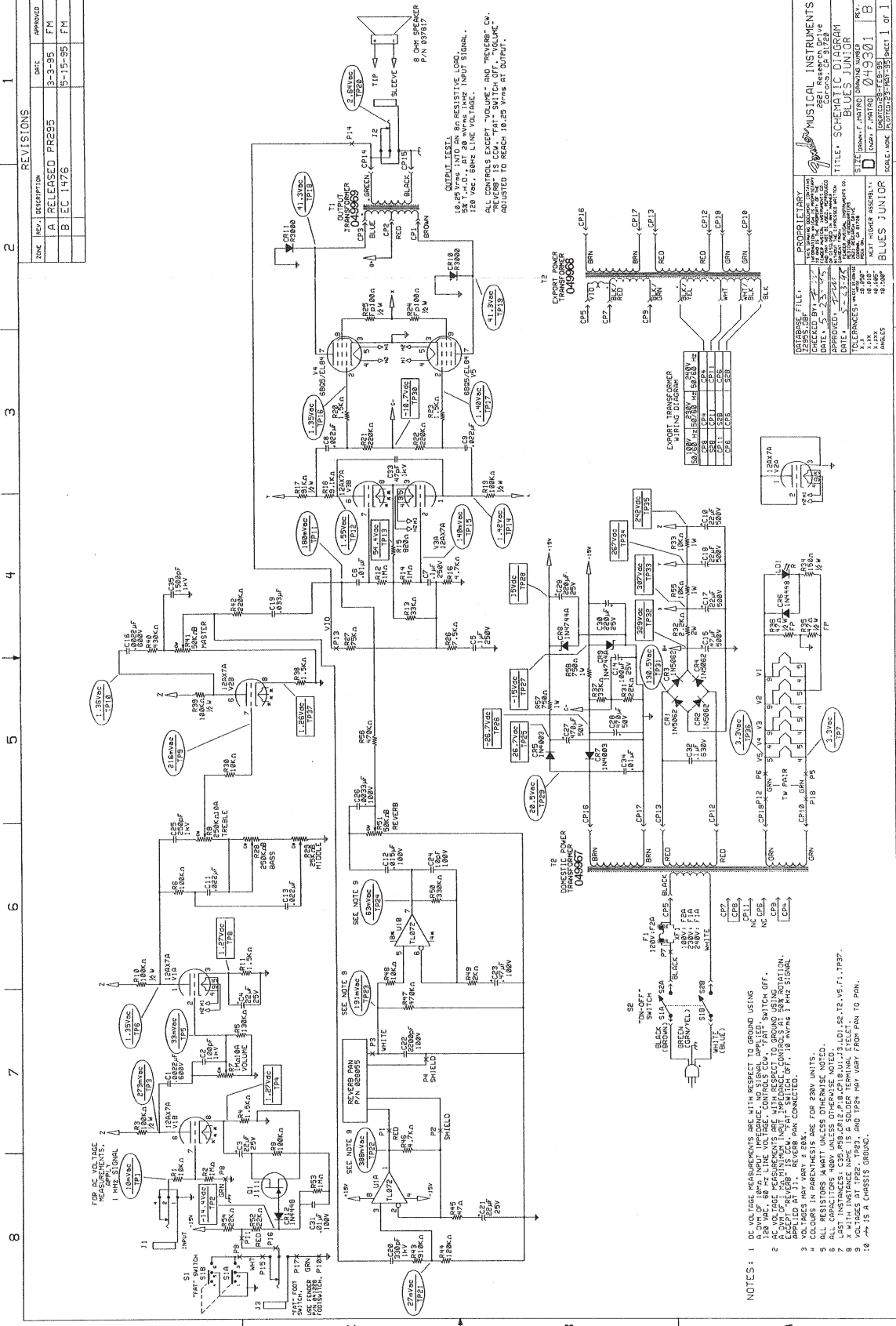

- NOTES:
1. DO NOT USE METERS WITH RESPECT TO GROUND USING A COM OF 100Ω INPUT IMPEDANCE. NO SIGNAL APPLIED.
 2. 120 VOLTS 60 HZ LINE VOLTAGE. CONTROLS CALIBRATED, SWITCH OFF. A CYCLE OF 15 MINUTES TO ALLOW TUBES TO WARM UP. CHECK THE VOLUME CONTROL AT 50% ROTATION.
 3. VOLTAGE MAY VARY ± 2.8% FOR 230V UNITS.
 4. ALL RESISTORS MUST BE UNLESS OTHERWISE NOTED.
 5. ALL CAPACITORS MUST BE UNLESS OTHERWISE NOTED.
 6. LAST INDUCTOR CBS P88 COIL FOR TE18U13 LOUDSPEAKER UNIT.
 7. RESISTOR TOLERANCES: 1% FOR 1K, 5% FOR ALL OTHERS.
 8. ALL CAPACITORS TOLERANCES: ± 5% UNLESS OTHERWISE NOTED.
 9. VOLTAGE AT TP2, TP3, AND TP4 MAY VARY FROM PAN TO PAN.
 10. → IS A CHASSIS GROUND.

REVISIONS

ZONE	REV.	DESCRIPTION	DWG	APPROVED
A	RELEASED	PR295	3-3-95	FM
B	LEC	1476	5-15-95	FM

PROPERTY OF
MUSICAL INSTRUMENTS

DATE: 12/29/05
APPROVED: [Signature]
DRAWN: [Signature]
CHECKED: [Signature]
DATE: 12/29/05
DESIGNED: [Signature]
DATE: 12/29/05
REVISION: [Signature]
DATE: 12/29/05
DATE: 12/29/05
DATE: 12/29/05
DATE: 12/29/05
DATE: 12/29/05
DATE: 12/29/05
DATE: 12/29/05

TITLE: SCHEMATIC OF GEAR
BLUES JUNIOR

SHEET NUMBER: 049301
TOTAL SHEETS: 1

DESIGNER: [Signature]
DRAWING NUMBER: 049301
REV. [Signature]

10.05 Vrms INTO AN 8Ω RESISTIVE LOAD.
120 VAC, 60 Hz, 100 Vrms LINE INPUT SIGNAL.
RECEIVER IS CALIBRATED TO GIVE A VOLTAJE OF 10.05 Vrms AT OUTPUT.
ADJUSTED TO REACH 10.05 Vrms AT OUTPUT.

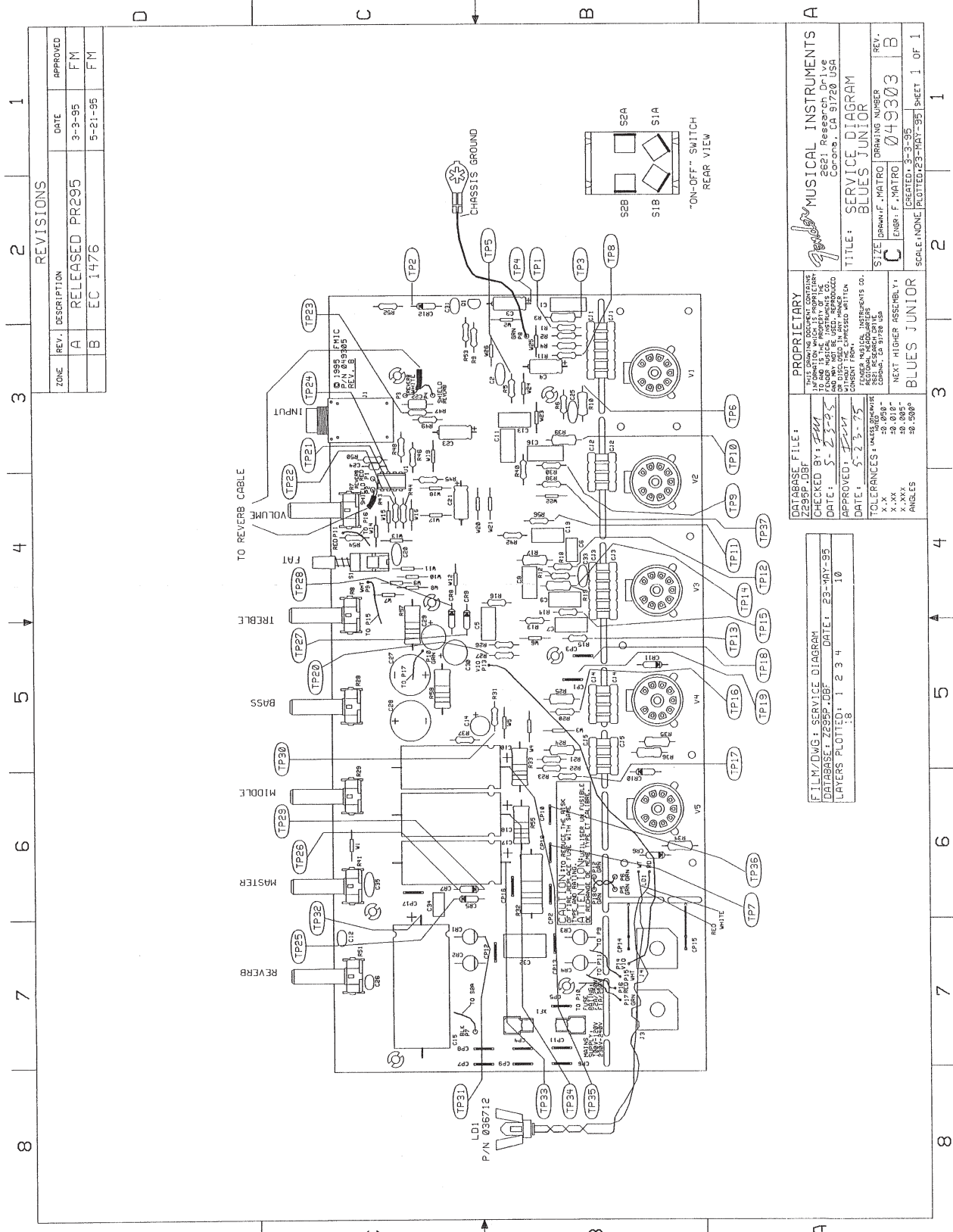

REVISIONS			
ZONE	REV. DESCRIPTION	DATE	APPROVED
A	RELEASED PR295	3-3-95	FM
B	EC 1476	5-21-95	FM

PROPRIETARY THIS DRAWING DOCUMENT CONTAINS INFORMATION WHICH IS PROPRIETARY TO FENDER MUSICAL INSTRUMENTS CO. OR IS USED IN ANY MANNER WITHOUT CONSENT FROM FENDER MUSICAL INSTRUMENTS CO.	
DATABASE FILE: Z295P.DBF CHECKED BY: <i>SM</i> DATE: 5-2-95 APPROVED: <i>SM</i> DATE: 5-2-95	TITLE: SERVICE DIAGRAM BLUES JUNIOR
TOLERANCES UNLESS SHOWN: X .010" X .015" X .030" X .045" X .055" ANGLES 90° UNLESS SHOWN	SIZE: C DRAWING NUMBER: 049303 DRAWING NUMBER: 049303 DRAWING NUMBER: 049303 SCALE: NONE PLOTTED: 23-MAY-95 SHEET 1 OF 1

FILM/DWG: SERVICE DIAGRAM DATABASE: Z295P.DBF LAYERS PLOTTED: 1 2 3 4 .B	DATE: 23-MAY-95
---	-----------------

REVISIONS		
ZONE	REV. DESCRIPTION	DATE
A	RELEASED PR295	3-3-95 FM
B	EC 1476	5-15-95 FM
C	LEC CR59	10-29-96 FM

MUSICAL INSTRUMENTS		
DATE	REV.	DESCRIPTION
12/10/96	1	INITIAL RELEASE
12/10/96	2	REVISIONS
12/10/96	3	REVISIONS
12/10/96	4	REVISIONS
12/10/96	5	REVISIONS
12/10/96	6	REVISIONS
12/10/96	7	REVISIONS
12/10/96	8	REVISIONS

049302000
1 OF 1

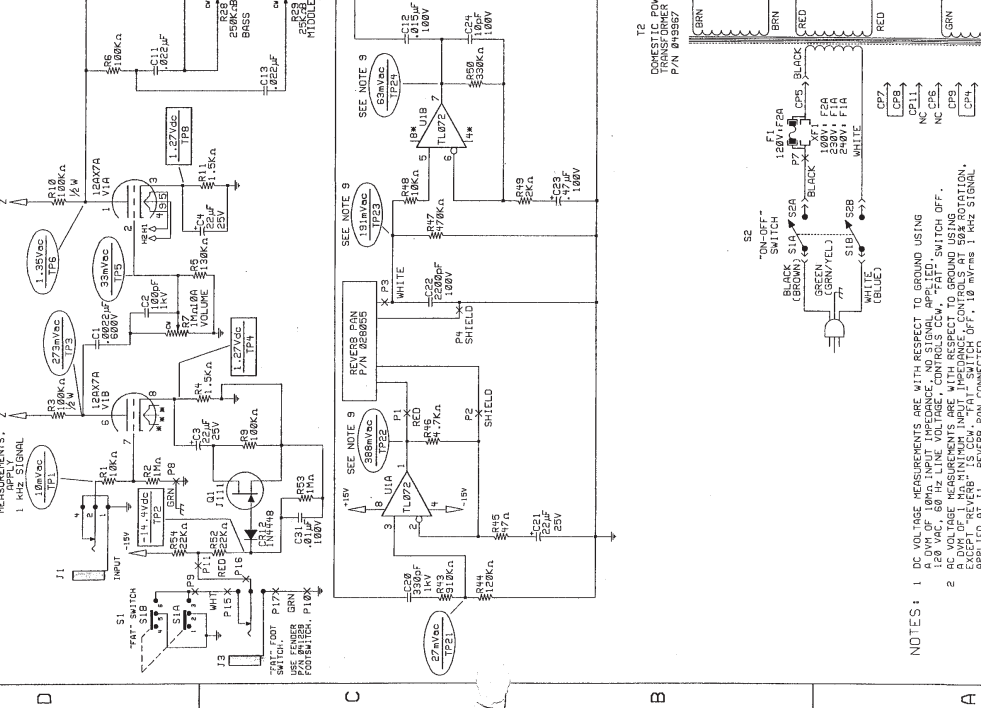
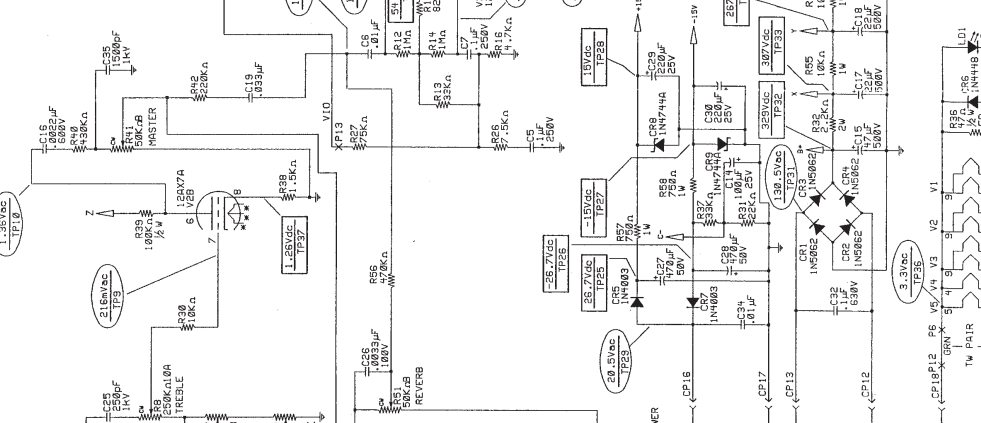
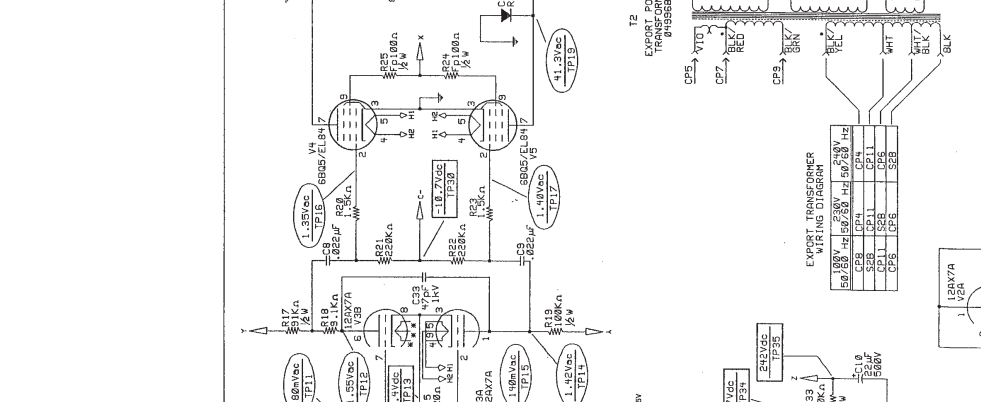
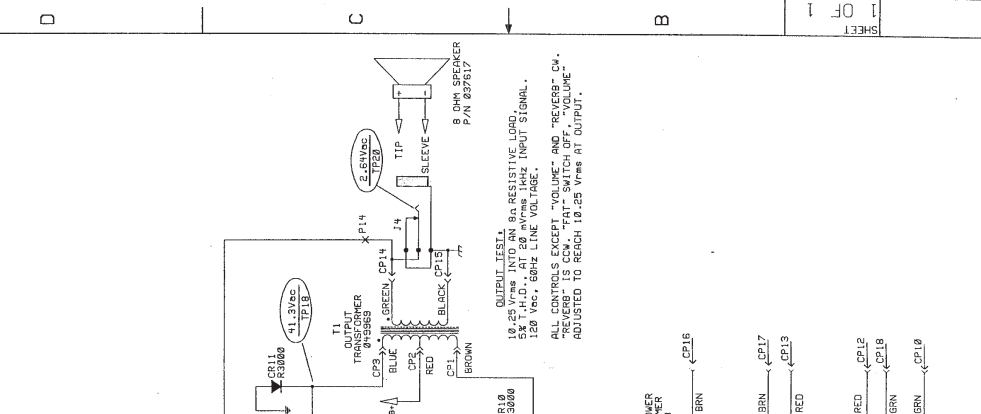

FOR AC VOLTAGE MEASUREMENTS, Z
1. 1.35Vdc TP18
2. 1.25Vdc TP19
3. 1.25Vdc TP20
4. 1.25Vdc TP21
5. 1.25Vdc TP22
6. 1.25Vdc TP23
7. 1.25Vdc TP24
8. 1.25Vdc TP25
9. 1.25Vdc TP26
10. 1.25Vdc TP27
11. 1.25Vdc TP28
12. 1.25Vdc TP29
13. 1.25Vdc TP30
14. 1.25Vdc TP31
15. 1.25Vdc TP32
16. 1.25Vdc TP33
17. 1.25Vdc TP34
18. 1.25Vdc TP35
19. 1.25Vdc TP36
20. 1.25Vdc TP37
21. 1.25Vdc TP38
22. 1.25Vdc TP39
23. 1.25Vdc TP40
24. 1.25Vdc TP41
25. 1.25Vdc TP42
26. 1.25Vdc TP43
27. 1.25Vdc TP44
28. 1.25Vdc TP45
29. 1.25Vdc TP46
30. 1.25Vdc TP47
31. 1.25Vdc TP48
32. 1.25Vdc TP49
33. 1.25Vdc TP50
34. 1.25Vdc TP51
35. 1.25Vdc TP52
36. 1.25Vdc TP53
37. 1.25Vdc TP54
38. 1.25Vdc TP55
39. 1.25Vdc TP56
40. 1.25Vdc TP57
41. 1.25Vdc TP58
42. 1.25Vdc TP59
43. 1.25Vdc TP60
44. 1.25Vdc TP61
45. 1.25Vdc TP62
46. 1.25Vdc TP63
47. 1.25Vdc TP64
48. 1.25Vdc TP65
49. 1.25Vdc TP66
50. 1.25Vdc TP67
51. 1.25Vdc TP68
52. 1.25Vdc TP69
53. 1.25Vdc TP70
54. 1.25Vdc TP71
55. 1.25Vdc TP72
56. 1.25Vdc TP73
57. 1.25Vdc TP74
58. 1.25Vdc TP75
59. 1.25Vdc TP76
60. 1.25Vdc TP77
61. 1.25Vdc TP78
62. 1.25Vdc TP79
63. 1.25Vdc TP80
64. 1.25Vdc TP81
65. 1.25Vdc TP82
66. 1.25Vdc TP83
67. 1.25Vdc TP84
68. 1.25Vdc TP85
69. 1.25Vdc TP86
70. 1.25Vdc TP87
71. 1.25Vdc TP88
72. 1.25Vdc TP89
73. 1.25Vdc TP90
74. 1.25Vdc TP91
75. 1.25Vdc TP92
76. 1.25Vdc TP93
77. 1.25Vdc TP94
78. 1.25Vdc TP95
79. 1.25Vdc TP96
80. 1.25Vdc TP97
81. 1.25Vdc TP98
82. 1.25Vdc TP99
83. 1.25Vdc TP100

1. DC VOLTAGE MEASUREMENTS ARE WITH RESPECT TO GROUND USING A 10MΩ 100V IMPEDANCE AND SIGNAL APPLIED SWITCH OFF.
2. AC VOLTAGE MEASUREMENTS ARE WITH RESPECT TO GROUND USING A 10MΩ 100V IMPEDANCE AND SIGNAL APPLIED SWITCH ON.
3. VOLTAGES MAY VARY ± 20%.
4. COLORS IN PARENTHESES ARE FOR 200V UNITS.
5. ALL CAPACITORS 400V UNLESS OTHERWISE NOTED.
6. LAST INSTANCES * C35, R58, C12, P18, U1, J3, L01, S2, 12, V5, F1, TP37.
7. X WITH INSTANCE NAME IS A SOLDER TERMINAL EYELET.
8. P18 IS A 200V SWITCH.
9. P18 IS A 200V SWITCH.
10. P18 IS A 200V SWITCH.
11. INSTANCES NOT USED, J2.

EXPORT POWER TRANSFORMER WIRING DIAGRAM
1. 1.25Vdc TP18
2. 1.25Vdc TP19
3. 1.25Vdc TP20
4. 1.25Vdc TP21
5. 1.25Vdc TP22
6. 1.25Vdc TP23
7. 1.25Vdc TP24
8. 1.25Vdc TP25
9. 1.25Vdc TP26
10. 1.25Vdc TP27
11. 1.25Vdc TP28
12. 1.25Vdc TP29
13. 1.25Vdc TP30
14. 1.25Vdc TP31
15. 1.25Vdc TP32
16. 1.25Vdc TP33
17. 1.25Vdc TP34
18. 1.25Vdc TP35
19. 1.25Vdc TP36
20. 1.25Vdc TP37
21. 1.25Vdc TP38
22. 1.25Vdc TP39
23. 1.25Vdc TP40
24. 1.25Vdc TP41
25. 1.25Vdc TP42
26. 1.25Vdc TP43
27. 1.25Vdc TP44
28. 1.25Vdc TP45
29. 1.25Vdc TP46
30. 1.25Vdc TP47
31. 1.25Vdc TP48
32. 1.25Vdc TP49
33. 1.25Vdc TP50
34. 1.25Vdc TP51
35. 1.25Vdc TP52
36. 1.25Vdc TP53
37. 1.25Vdc TP54
38. 1.25Vdc TP55
39. 1.25Vdc TP56
40. 1.25Vdc TP57
41. 1.25Vdc TP58
42. 1.25Vdc TP59
43. 1.25Vdc TP60
44. 1.25Vdc TP61
45. 1.25Vdc TP62
46. 1.25Vdc TP63
47. 1.25Vdc TP64
48. 1.25Vdc TP65
49. 1.25Vdc TP66
50. 1.25Vdc TP67
51. 1.25Vdc TP68
52. 1.25Vdc TP69
53. 1.25Vdc TP70
54. 1.25Vdc TP71
55. 1.25Vdc TP72
56. 1.25Vdc TP73
57. 1.25Vdc TP74
58. 1.25Vdc TP75
59. 1.25Vdc TP76
60. 1.25Vdc TP77
61. 1.25Vdc TP78
62. 1.25Vdc TP79
63. 1.25Vdc TP80
64. 1.25Vdc TP81
65. 1.25Vdc TP82
66. 1.25Vdc TP83
67. 1.25Vdc TP84
68. 1.25Vdc TP85
69. 1.25Vdc TP86
70. 1.25Vdc TP87
71. 1.25Vdc TP88
72. 1.25Vdc TP89
73. 1.25Vdc TP90
74. 1.25Vdc TP91
75. 1.25Vdc TP92
76. 1.25Vdc TP93
77. 1.25Vdc TP94
78. 1.25Vdc TP95
79. 1.25Vdc TP96
80. 1.25Vdc TP97
81. 1.25Vdc TP98
82. 1.25Vdc TP99
83. 1.25Vdc TP100

EXPORT POWER TRANSFORMER WIRING DIAGRAM
1. 1.25Vdc TP18
2. 1.25Vdc TP19
3. 1.25Vdc TP20
4. 1.25Vdc TP21
5. 1.25Vdc TP22
6. 1.25Vdc TP23
7. 1.25Vdc TP24
8. 1.25Vdc TP25
9. 1.25Vdc TP26
10. 1.25Vdc TP27
11. 1.25Vdc TP28
12. 1.25Vdc TP29
13. 1.25Vdc TP30
14. 1.25Vdc TP31
15. 1.25Vdc TP32
16. 1.25Vdc TP33
17. 1.25Vdc TP34
18. 1.25Vdc TP35
19. 1.25Vdc TP36
20. 1.25Vdc TP37
21. 1.25Vdc TP38
22. 1.25Vdc TP39
23. 1.25Vdc TP40
24. 1.25Vdc TP41
25. 1.25Vdc TP42
26. 1.25Vdc TP43
27. 1.25Vdc TP44
28. 1.25Vdc TP45
29. 1.25Vdc TP46
30. 1.25Vdc TP47
31. 1.25Vdc TP48
32. 1.25Vdc TP49
33. 1.25Vdc TP50
34. 1.25Vdc TP51
35. 1.25Vdc TP52
36. 1.25Vdc TP53
37. 1.25Vdc TP54
38. 1.25Vdc TP55
39. 1.25Vdc TP56
40. 1.25Vdc TP57
41. 1.25Vdc TP58
42. 1.25Vdc TP59
43. 1.25Vdc TP60
44. 1.25Vdc TP61
45. 1.25Vdc TP62
46. 1.25Vdc TP63
47. 1.25Vdc TP64
48. 1.25Vdc TP65
49. 1.25Vdc TP66
50. 1.25Vdc TP67
51. 1.25Vdc TP68
52. 1.25Vdc TP69
53. 1.25Vdc TP70
54. 1.25Vdc TP71
55. 1.25Vdc TP72
56. 1.25Vdc TP73
57. 1.25Vdc TP74
58. 1.25Vdc TP75
59. 1.25Vdc TP76
60. 1.25Vdc TP77
61. 1.25Vdc TP78
62. 1.25Vdc TP79
63. 1.25Vdc TP80
64. 1.25Vdc TP81
65. 1.25Vdc TP82
66. 1.25Vdc TP83
67. 1.25Vdc TP84
68. 1.25Vdc TP85
69. 1.25Vdc TP86
70. 1.25Vdc TP87
71. 1.25Vdc TP88
72. 1.25Vdc TP89
73. 1.25Vdc TP90
74. 1.25Vdc TP91
75. 1.25Vdc TP92
76. 1.25Vdc TP93
77. 1.25Vdc TP94
78. 1.25Vdc TP95
79. 1.25Vdc TP96
80. 1.25Vdc TP97
81. 1.25Vdc TP98
82. 1.25Vdc TP99
83. 1.25Vdc TP100

049302000
1 OF 1

1 2 3 4 5 6 7 8

REVISIONS			
ZONE	REV. DESCRIPTION	DATE	APPROVED
A	RELEASED PR295	3-3-95	FM
B	EC 1476	5-21-95	FM
C	EC 2214	12-02-98	MDW

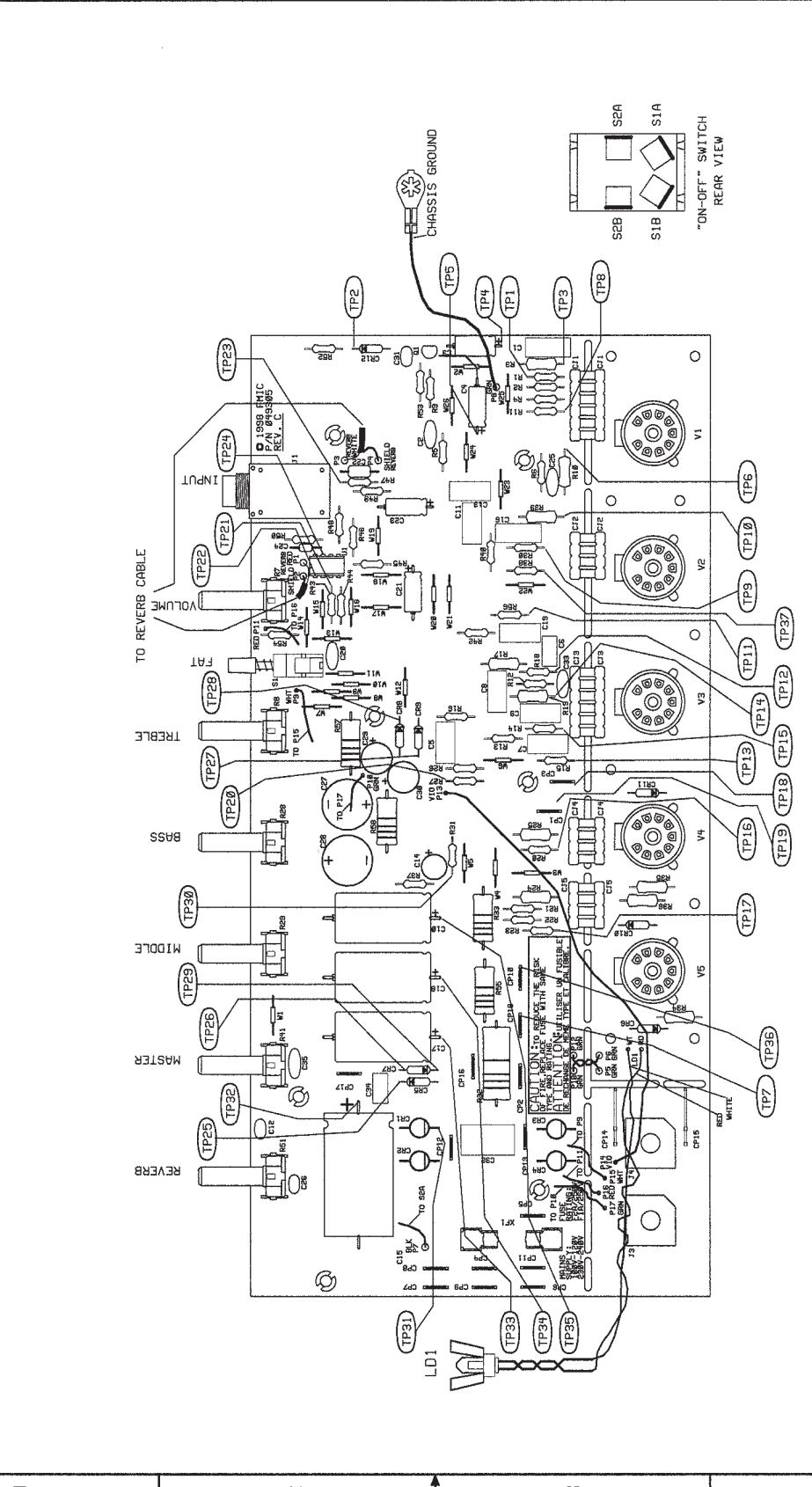

PROPRIETARY
THIS DRAWING DOCUMENT CONTAINS
INFORMATION THAT IS THE PROPERTY OF THE
DRAWER AND IS NOT TO BE REPRODUCED
OR TRANSMITTED IN ANY MANNER
WITHOUT THE WRITTEN CONSENT OF THE
DRAWER.

Blues Junior

SIZE: DRAWING NUMBER: **C** 049303
 ENGR: F. MATRO
 CREATED: 3-3-95
 PLOTTED: 02-DEC-98

Blues Junior

DATE: 02-DEC-98
 DATE: 10

DATE: 1 2 3 4
 DATE: 10

DATE: 10

2621 Rescorla Dr. #200
 Corona, CA 91728 USA

MUSICAL INSTRUMENTS

Blues Junior

SCALE: NONE PLOTTED: 02-DEC-98 SHEET 1 OF 1

REVISIONS		
ZONE	REVISION DESCRIPTION	DATE
A	RELEASED PR295	3-3-95
B	EC 1476	5-15-95
C	EC CR59	10-23-96
D	EC 2214	07-29-98

REVISIONS		
ZONE	REVISION DESCRIPTION	DATE
A	RELEASED PR295	3-3-95
B	EC 1476	5-15-95
C	EC CR59	10-23-96
D	EC 2214	07-29-98

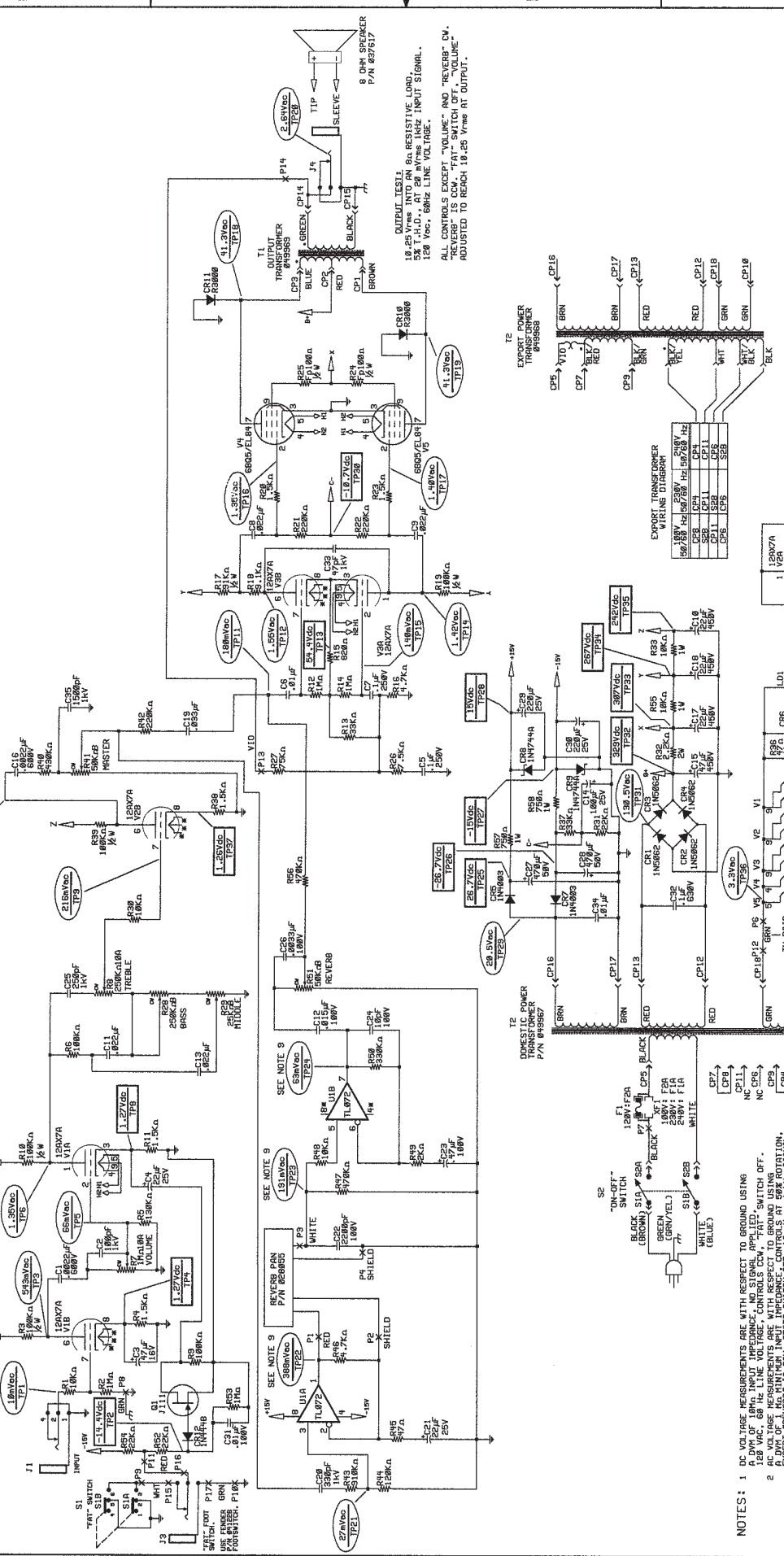

PROPRIETARY	
MUSICAL INSTRUMENTS	
2021 Research Dr. Ave	
BLUES JUNIOR	
TITLE: SCHEMATIC DIAGRAM	
SIZE: 11x17	
DRAWN: F. MOTO	
CHECKED: J. LEE	
DATE: 2/1/97	
SCALE: 1:1	
SHEET 1 OF 1	

DC VOLTAGE MEASUREMENTS ARE WITH RESPECT TO GROUND USING 100V AC, 60 HZ LINE VOLTAGE. CONTROL SW. IS PATED SWITCH OFF.

AC VOLTAGE MEASUREMENTS ARE WITH RESPECT TO GROUND USING 100V AC, 60 HZ LINE VOLTAGE. CONTROL SW. IS PATED SWITCH OFF.

EXCEPT "REVERB" IS COMMON TO ALL INSTANCES. "REVERB" IS COMMON TO ALL INSTANCES. "REVERB" IS COMMON TO ALL INSTANCES.

APPLIED AT J1 - REVERB PAN CONNECTED.

ALL CAPACITORS UNLESS OTHERWISE NOTED.

ALL RESISTORS UNLESS OTHERWISE NOTED.

LAST INSTANCES: C95, R99, C12, P16, C19, J1, J3, L1, S2, T2, V5, F1, TP37.

VOLTAGE INSTANCES: C95, R99, C12, P16, C19, J1, J3, L1, S2, T2, V5, F1, TP37.

AND THEY MAY VARY FROM PAN TO PAN.

INSTANCES NOT USED: 12.

1 2 3 4 5 6 7 8

REVISIONS			
ZONE	REV. DESCRIPTION	DATE	APPROVED
A	RELEASED PR295	3-3-95	FM
B	EC 1476	5-21-95	FM
C	EC 2214	12-02-98	MDW

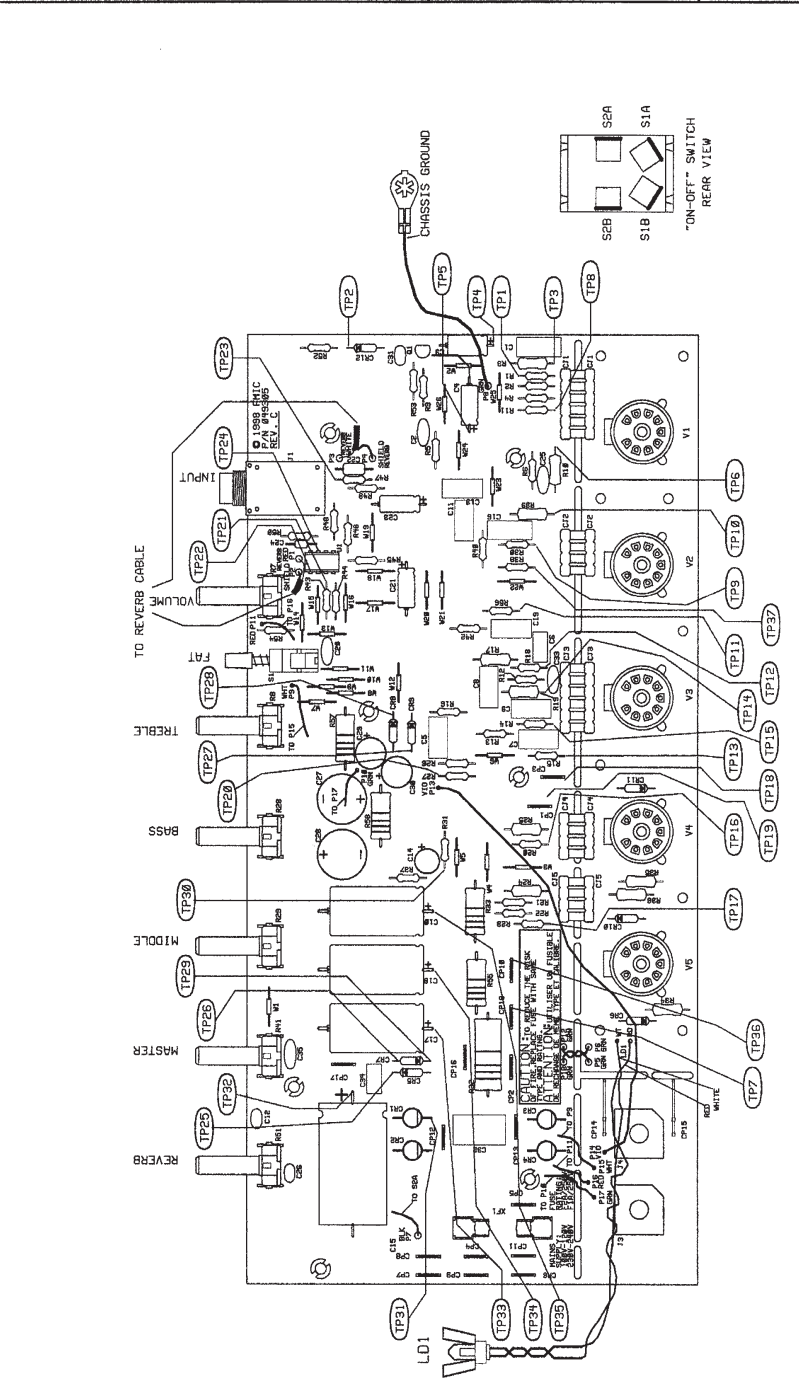

DATABASE FILE: Z295P.LDF CHECKED BY: DATE: 9/18/94 APPROVED: DATE: 2/18/94 TOLERANCES: MILLIMETERS X.X X.XX X.XXX ANGLES 90 50MP 90 50MP	PROPRIETARY THESE PRELIMINARY DOCUMENTS CONTAIN THE PROPERTY OF GIBSON GUITAR CORPORATION AND ARE NOT TO BE REPRODUCED OR TRANSMITTED IN ANY FORM OR BY ANY MEANS WITHOUT THE EXPRESS WRITTEN PERMISSION OF GIBSON GUITAR CORPORATION, 125 SOUTH MAIN STREET, MEMPHIS, TN 38103 USA
FILL/MDWG: SERVICE DIAGRAM DATABASE: Z295P.LDF LAYERS PLOTTED: 1 2 3 4 18	TITLE: BLUES JUNIOR SIZE: 11.5" x 17" ENGR: F. MATRO DRAWN: J. GUNTER C 049303 CREATED: 3-3-95 PLOTTED: 02-DEC-98 SCALE: NONE SHEET 1 OF 1

MUSICAL INSTRUMENTS
 GIBSON GUITAR CORPORATION
 125 SOUTH MAIN STREET
 MEMPHIS, TN 38103 USA
 TEL: 901-526-7000
 FAX: 901-526-7001
 WWW.GIBSON.COM

1 2 3 4 5 6 7 8

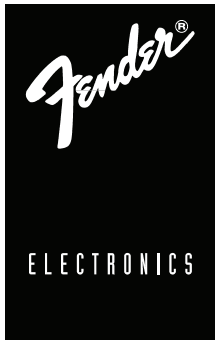

SUPPLEMENT TO: **BLUES JUNIOR**

p/n 021-3105-000 (120V)

SERVICE MANUAL

Reason for supplement: Reverb improvements and improved manufacturability require changes to the PCB and to the BOM. This supplement contains parts lists and schematics of the new circuitry. Please file it with your original service manual.



CONTENTS:

Parts lists:
PCB assembly
Schematics/diagrams

SUPPLEMENT TO: BLUES JUNIOR

PARTS LIST

NOTE: SHADED ITEMS ARE FOR REFERENCE ONLY

PRINTED CIRCUIT BOARD ASSEMBLY

QTY	PART #	DESCRIPTION	REFERENCE DESIGNATION
3	0029533000	CABLE JMPR 22GA 4 CKT 3.2"	PW2 PW4 PW5
2	0050687000	CABLE JMPR 6 CKT .156 ROUND	PW1 PW3
1	0028577000	CABLE REVERB 30"	@ WJ1-4
1	0038689001	CAP AE AX .47uF 100V 20%	C20
2	0009512001	CAP AE AX 22uF 25V 20%	C4 C18
3	0051720000	CAP AE AX 22uF 450V 20%	C26-28
1	0038693001	CAP AE AX 47uF 16V 20%	C1
1	0051719000	CAP AE AX 47uF 450V 20%	C25
1	0028474003	CAP AE RDL 100uF 25V 20%	C33
2	0028479003	CAP AE RDL 220uF 25V 20%	C31 C34
2	0028489000	CAP AE RDL 470uF 50V 20%	C30 C32
1	0038698001	CAP CA 47pF 100V	C21
1	0039265001	CAP CA 2200pF 100V	C19
1	0051457003	CAP CD 100pF 500V 5%	C3
1	0051458003	CAP CD 470pF 500V 10%	C17
1	0020909000	CAP CD 47pF 1000V 10%	C14
1	0020917000	CAP CD 250pF 1000V 10%	C5
1	0017620000	CAP CD 1500PF 1000V 10%	C9
2	0024823000	CAP MPF RDL .01uF 400V 10%	C11 C29
4	0024833000	CAP MPF RDL .022uF 400V 10%	C6-7 C15-16
1	0024839000	CAP MPF RDL .033uF 400V 10%	C10
2	0024853000	CAP MPF RDL .1uF 250V 10%	C12-13
1	0024855000	CAP MPF RDL .1uF 630V 10%	C24
2	0026202002	CAP PFF .0022uF 400V 10%	C2 C8
1	0033581003	CAP PFF RDL .0033uF 100V 10%	C23
1	0033588003	CAP PFF RDL .01uF 100V 10%	C35
1	0036234003	CAP PFF RDL .015uF 100V 10%	C22
1	0049402000	CONTROL SNAPIN 25k B	R14 <i>Middle</i>
2	0034719000	CONTROL SNAPIN 50k B	R19 R45 <i>Master, Reverb</i>
1	0041913000	CONTROL SNAPIN 250k 10A	R13 <i>Bass</i>
1	0040985000	CONTROL SNAPIN 250k B	R12 <i>Treble</i>
1	0049401000	CONTROL SNAPIN 1M 10A	R5 <i>Volume</i>
2	0064089001	DIODE 1N4003	D5-6
4	0026730001	DIODE 1N4006 800V 1A	D1-4
3	0006260001	DIODE 1N4448 SIGNAL	D9 D13-14
2	0029690001	DIODE HV 3kV 200mA	D11-12
2	0009165001	DIODE ZEN 1N4744A 15V 1W 5%	D7-8
16	0025802000	FSTN TAB MALE .250x.032 PCB MT	P1-16
2	0031041000	FSTN TAB ML RTANG PCB .25x.032	P17-18
2	0025996000	FUSE CLIP PCB 1/4" & 5mm DUAL	F1
1	0031611000	IC OP-AMP DUAL PC4560	U1
1	0030771000	JACK 1/4 PCB 2/CD SCC	J3 <i>Speaker</i>
1	0027674000	JACK 1/4 PCB 2/CD SCC INSL	J2 <i>Footswitch</i>
1	0037036000	JACK PHONE PCB MONO PREM	J1 <i>Input</i>

SUPPLEMENT TO: BLUES JUNIOR

PRINTED CIRCUIT BOARD ASSEMBLY (CONT)

QTY	PART #	DESCRIPTION	REFERENCE DESIGNATION
1	0056975000	LED RED PNL MT 7"	D10
1	0024947001	RES CF 1/4W 5% 47ohm LL	R39
1	0024964001	RES CF 1/4W 5% 820ohm LL	R24
5	0024969001	RES CF 1/4W 5% 1.5k LL	R4 R10 R17 R33-34
1	0029005001	RES CF 1/4W 5% 2k LL	R43
2	0024977001	RES CF 1/4W 5% 4.7k LL	R26 R40
1	0025942001	RES CF 1/4W 5% 7.5k LL	R25
1	0026510001	RES CF 1/4W 5% 9.1k LL	R29
4	0024981001	RES CF 1/4W 5% 10k LL	R2 R7 R15 R42
3	0024987001	RES CF 1/4W 5% 22k LL	R52 R57-58
2	0024989001	RES CF 1/4W 5% 33k LL	R21 R51
1	0024995001	RES CF 1/4W 5% 68k LL	R38
1	0028153001	RES CF 1/4W 5% 75k LL	R27
3	0024997001	RES CF 1/4W 5% 100k LL	R9 R11 R46
1	0028955001	RES CF 1/4W 5% 130k LL	R6
5	0025059001	RES CF 1/4W 5% 220k LL	R20 R31-32 R41 R44
1	0025828001	RES CF 1/4W 5% 430k LL	R18
5	0025069001	RES CF 1/4W 5% 1M LL	R1 R22-23 R37 R59
1	0025829001	RES CF 1/2W 5% 150ohm LL	R56
1	0031065001	RES CF 1/2W 5% 91k LL	R28
4	0025116001	RES CF 1/2W 5% 100k LL	R3 R8 R16 R30
2	0041741001	RES MOX FP 1/2W 5% 47ohm LL	R54-55
2	0028580001	RES MOX FP 1/2W 5% 100ohm LL	R35-36
2	0031067001	RES FILM 1W 5% 750ohm LL	R50 R53
2	0027349001	RES FILM 1W 5% 10k LL	R48-49
1	0041258001	RES MOX 2W 5% 2.2k LL	R47
1	0028091000	SWITCH PUSH SLFLK	S1
1	0028104000	BUTTON PUSH SWITCH BLACK	AT S1
5	0029167000	TUBE SOCKET 9 PIN PCB MOUNT	V1-5
REF	0038519000	STANDOFF M/F 4-40 x 1/4L	
REF	0097360000	NUT HEX 4-40 EX LOCK	
REF	0047040000	STANDOFF NYL PCB SNAP 1/2" BLK	
1	0014689003	XSTR N-CH JFET J111 TO-92	Q1
1	0057276000	PCB FAB BLUES JUNIOR	
REF	0057275000	SERVICE DIAGRAM	

REV.	DESCRIPTION	DATE	APPROVED
A	EC 2630	21-MAR-01	GBL

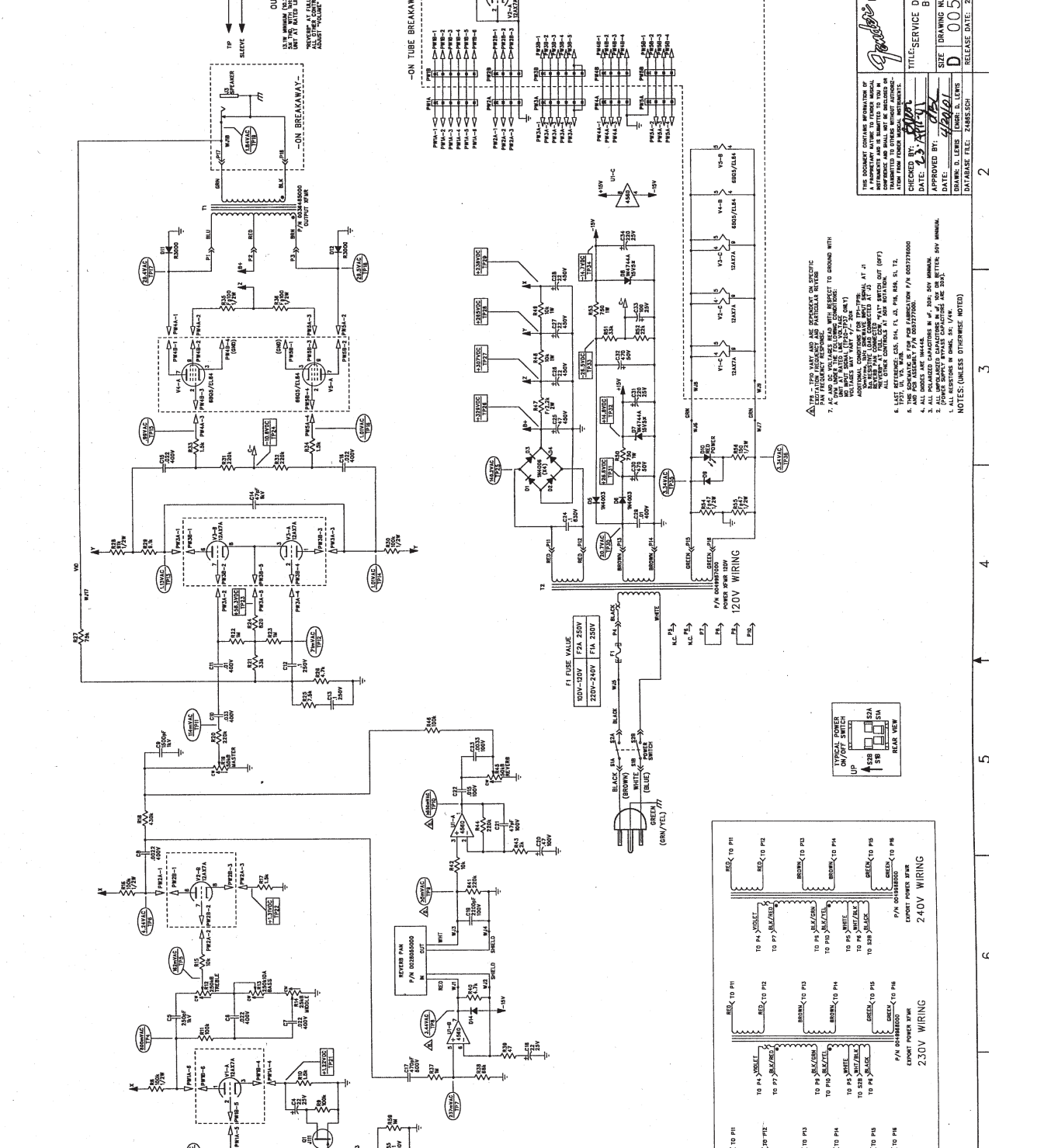

1
2
3
4
5
6
7
8

D
C
B
A

MUSICAL INSTRUMENTS
Corona, CA U.S.A.

DESIGNED BY: **DAVID L. LEWIS**
DATE: **4/10/01**

APPROVED BY: **DAVID L. LEWIS**
DATE: **4/10/01**

REVISIONS: **1**

TITLE: SERVICE DIAGRAM, COMBINED
BLUES JUNIORS

SIZE: DRAWING NUMBER **D 0057275000**

RELEASE DATE: **21-MAR-01** SHEET: **1 OF 2**

THIS DOCUMENT CONTAINS INFORMATION OF A TECHNICAL NATURE AND IS NOT TO BE REPRODUCED OR TRANSMITTED IN ANY FORM OR BY ANY MEANS, WITHOUT PERMISSION IN WRITING FROM MUSICAL INSTRUMENTS, CORONA, CA U.S.A.

7. AC AND DC VOLTAGE READ WITH RESPECT TO GROUND WITH INSTRUMENTS AND IS SHOWN IN THIS DRAWING.
8. ALL PARTS VALUES ARE IN OHMS UNLESS OTHERWISE NOTED.
9. ALL PARTS VALUES ARE IN PPM UNLESS OTHERWISE NOTED.
10. ALL PARTS VALUES ARE IN PERCENT UNLESS OTHERWISE NOTED.

ON-TUBE BREAKAWAY -

TYPE	VAL	VAL	VAL	VAL	VAL	VAL	VAL	VAL
100V	P2A1	P2A1	P2A1	P2A1	P2A1	P2A1	P2A1	P2A1
230V	P2A2	P2A2	P2A2	P2A2	P2A2	P2A2	P2A2	P2A2
240V	P2A3	P2A3	P2A3	P2A3	P2A3	P2A3	P2A3	P2A3

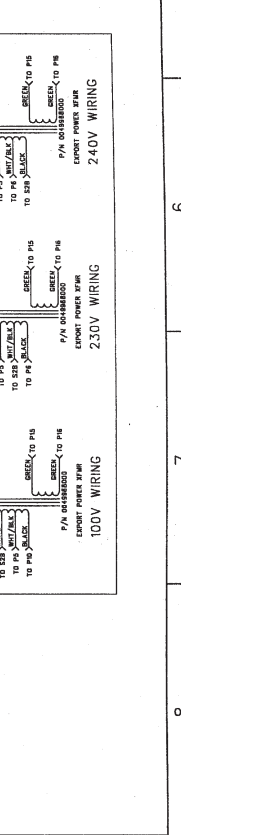

9
8
7
6
5
4
3
2
1

REVISIONS			
REV.	DESCRIPTION	DATE	APPROVED
A	EC 2630	21-MAR-01	dBL

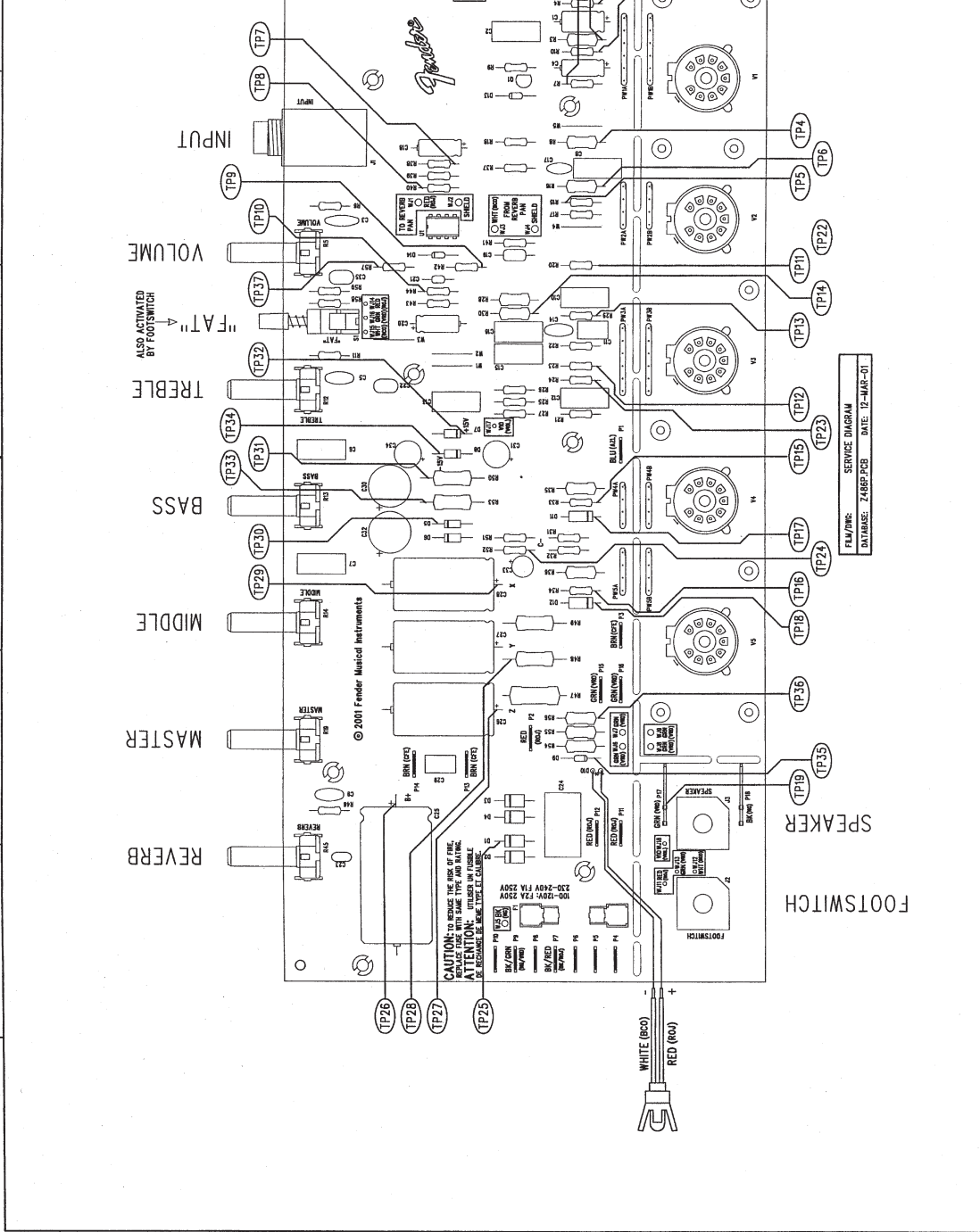

THIS DOCUMENT CONTAINS INFORMATION OF A PROPRIETARY NATURE TO FENDER MUSICAL INSTRUMENTS. IT IS THE PROPERTY OF FENDER MUSICAL INSTRUMENTS AND SHALL NOT BE REPRODUCED OR TRANSMITTED TO OTHERS WITHOUT AUTHORIZATION FROM FENDER MUSICAL INSTRUMENTS.	
CHECKED BY:	<i>[Signature]</i>
DATE:	7-6-01
APPROVED BY:	<i>[Signature]</i>
DATE:	4/20/01
DRAWN:	D. LEWIS
ENGINEER:	D. LEWIS
DATABASE FILE:	Z486P.PCB

MUSICAL INSTRUMENTS
Corona, CA U.S.A.

TITLE: SERVICE DIAGRAM, COMBINED (PCB assy)
BLUES JUNIOR

SIZE: C
DRAWING NUMBER: 0057275000
RELEASE DATE: 21-MAR-01
SHEET 2 OF 2

1. SEE SHEET 1 FOR PRIMARY WIRING, TEST CONDITIONS, AND TEST POINT VALUES.
NOTES: (UNLESS OTHERWISE NOTED)

1 2 3 4 5 6 7 8

D C B A

REV IS I O N S			
REV.	DESCRIPTION	DATE	APPROVED
A	EC 2630	21-MAR-01	gBL
B	EC 2767	09-APR-02	gBL

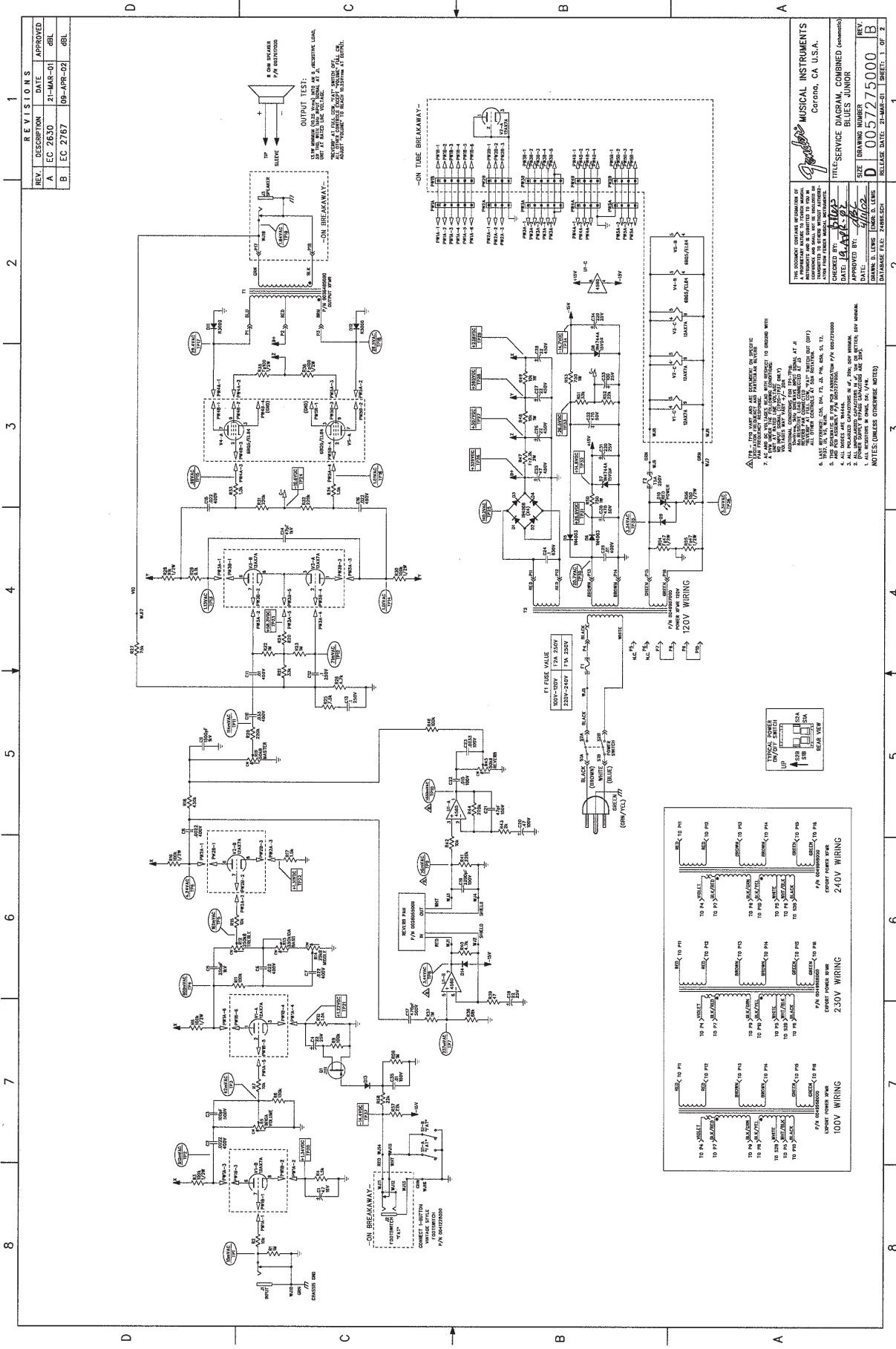

TITLE: **BLUES JUNIOR**
 SERVICE DIAGRAM COMBINED
 CHECKED BY: **gBL**
 DATE: **10/14/02**
 DRAWING NUMBER: **D 005725000**
 SIZE: **B**
 DRAWN BY: **gBL**
 DATE: **10/14/02**
 RELEASE DATE: **21-MAR-01** SHEET: **1** OF **2**

NOTES:
 1. THIS DIAGRAM IS FOR THE BLUES JUNIOR ONLY. IT IS NOT TO BE USED FOR ANY OTHER INSTRUMENT.
 2. ALL COMPONENTS ARE TO BE REPLACED WITH THE SAME TYPE AND VALUE UNLESS OTHERWISE NOTED.
 3. ALL WIRING IS TO BE DONE IN ACCORDANCE WITH THE NATIONAL ELECTRICAL CODE (NEC).
 4. ALL COMPONENTS ARE TO BE REPLACED WITH THE SAME TYPE AND VALUE UNLESS OTHERWISE NOTED.
 5. ALL WIRING IS TO BE DONE IN ACCORDANCE WITH THE NATIONAL ELECTRICAL CODE (NEC).
 6. ALL COMPONENTS ARE TO BE REPLACED WITH THE SAME TYPE AND VALUE UNLESS OTHERWISE NOTED.
 7. ALL WIRING IS TO BE DONE IN ACCORDANCE WITH THE NATIONAL ELECTRICAL CODE (NEC).
 8. ALL COMPONENTS ARE TO BE REPLACED WITH THE SAME TYPE AND VALUE UNLESS OTHERWISE NOTED.
 9. ALL WIRING IS TO BE DONE IN ACCORDANCE WITH THE NATIONAL ELECTRICAL CODE (NEC).
 10. ALL COMPONENTS ARE TO BE REPLACED WITH THE SAME TYPE AND VALUE UNLESS OTHERWISE NOTED.
 11. ALL WIRING IS TO BE DONE IN ACCORDANCE WITH THE NATIONAL ELECTRICAL CODE (NEC).
 12. ALL COMPONENTS ARE TO BE REPLACED WITH THE SAME TYPE AND VALUE UNLESS OTHERWISE NOTED.
 13. ALL WIRING IS TO BE DONE IN ACCORDANCE WITH THE NATIONAL ELECTRICAL CODE (NEC).
 14. ALL COMPONENTS ARE TO BE REPLACED WITH THE SAME TYPE AND VALUE UNLESS OTHERWISE NOTED.
 15. ALL WIRING IS TO BE DONE IN ACCORDANCE WITH THE NATIONAL ELECTRICAL CODE (NEC).

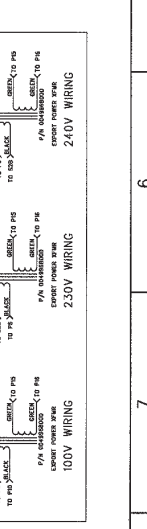
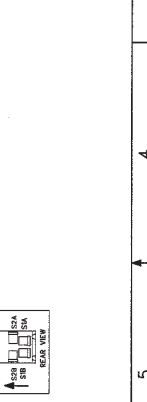

NOTES:
 1. THIS DIAGRAM IS FOR THE BLUES JUNIOR ONLY. IT IS NOT TO BE USED FOR ANY OTHER INSTRUMENT.
 2. ALL COMPONENTS ARE TO BE REPLACED WITH THE SAME TYPE AND VALUE UNLESS OTHERWISE NOTED.
 3. ALL WIRING IS TO BE DONE IN ACCORDANCE WITH THE NATIONAL ELECTRICAL CODE (NEC).
 4. ALL COMPONENTS ARE TO BE REPLACED WITH THE SAME TYPE AND VALUE UNLESS OTHERWISE NOTED.
 5. ALL WIRING IS TO BE DONE IN ACCORDANCE WITH THE NATIONAL ELECTRICAL CODE (NEC).
 6. ALL COMPONENTS ARE TO BE REPLACED WITH THE SAME TYPE AND VALUE UNLESS OTHERWISE NOTED.
 7. ALL WIRING IS TO BE DONE IN ACCORDANCE WITH THE NATIONAL ELECTRICAL CODE (NEC).
 8. ALL COMPONENTS ARE TO BE REPLACED WITH THE SAME TYPE AND VALUE UNLESS OTHERWISE NOTED.
 9. ALL WIRING IS TO BE DONE IN ACCORDANCE WITH THE NATIONAL ELECTRICAL CODE (NEC).
 10. ALL COMPONENTS ARE TO BE REPLACED WITH THE SAME TYPE AND VALUE UNLESS OTHERWISE NOTED.
 11. ALL WIRING IS TO BE DONE IN ACCORDANCE WITH THE NATIONAL ELECTRICAL CODE (NEC).
 12. ALL COMPONENTS ARE TO BE REPLACED WITH THE SAME TYPE AND VALUE UNLESS OTHERWISE NOTED.
 13. ALL WIRING IS TO BE DONE IN ACCORDANCE WITH THE NATIONAL ELECTRICAL CODE (NEC).
 14. ALL COMPONENTS ARE TO BE REPLACED WITH THE SAME TYPE AND VALUE UNLESS OTHERWISE NOTED.
 15. ALL WIRING IS TO BE DONE IN ACCORDANCE WITH THE NATIONAL ELECTRICAL CODE (NEC).

8 7 6 5 4 3 2 1

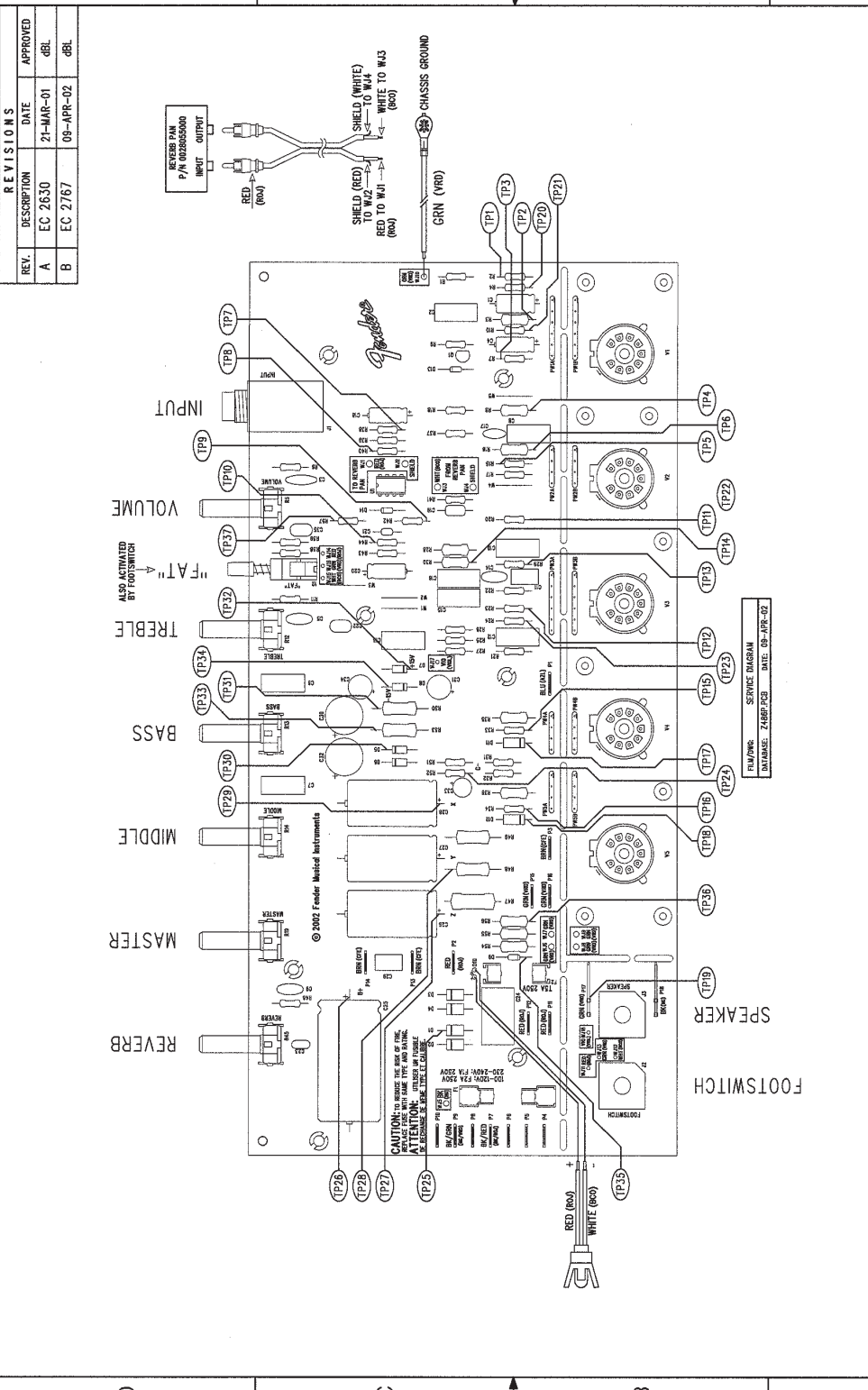

THIS DOCUMENT CONTAINS INFORMATION OF A PROPRIETARY NATURE TO FENDER MUSICAL INSTRUMENTS. IT IS THE PROPERTY OF FENDER MUSICAL INSTRUMENTS AND SHALL NOT BE REPRODUCED OR TRANSMITTED IN ANY FORM OR BY ANY MEANS, ELECTRONIC OR MECHANICAL, INCLUDING PHOTOCOPYING, RECORDING, OR BY ANY INFORMATION STORAGE AND RETRIEVAL SYSTEM, WITHOUT THE WRITTEN PERMISSION OF FENDER MUSICAL INSTRUMENTS.

CHECKED BY: *[Signature]*
 DATE: 11-11-01

APPROVED BY: *[Signature]*
 DATE: 4/11/02

DRAWN: D. LEWIS
 ENGR: D. LEWIS

DATABASE FILE: 748RP.PCB

TITLE: SERVICE DIAGRAM, COMBINED (PCBassy)
BLUES JUNIOR

SIZE: DRAWING NUMBER: **C 0057275000**

REV. B

RELEASE DATE: 21-MAR-01 **SHEET 2 OF 2**

1. SEE SHEET 1 FOR PRIMARY WIRING, TEST CONDITIONS, AND TEST POINT VALUES.

NOTES: (UNLESS OTHERWISE NOTED)

Fender
 MUSICAL INSTRUMENTS
 Corona, CA U.S.A.

REVISIONS			
REV.	DESCRIPTION	DATE	APPROVED
A	EC 2630	21-MAR-01	GBL
B	EC 2767	09-APR-02	GBL
C	EC 2871	06-JAN-03	GBL

1 2 3 4 5 6 7 8

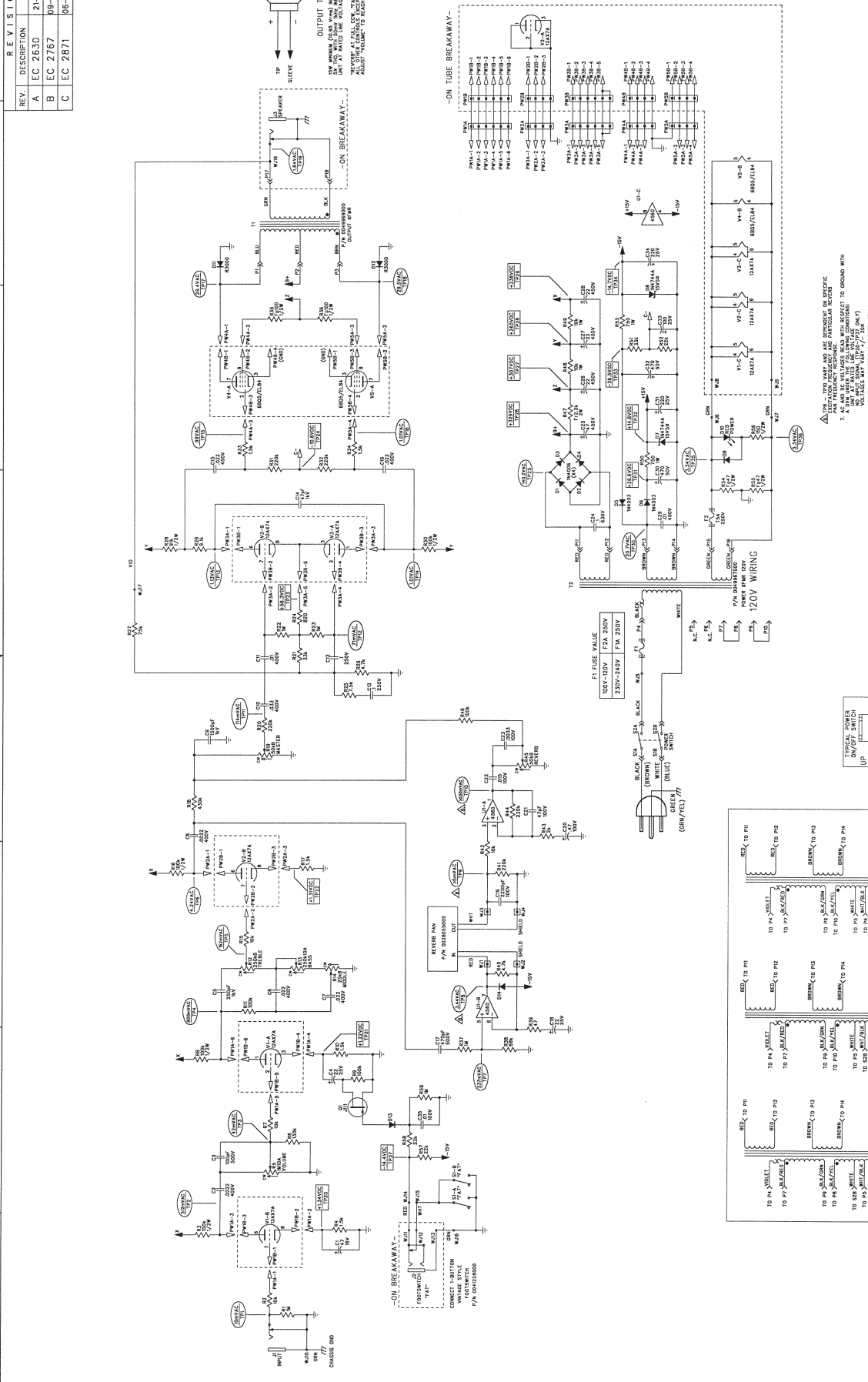

THE DOCUMENT IS THE PROPERTY OF
 JENSEN ELECTRONICS CORPORATION
 AND IS LOANED TO YOU BY THE
 INSTRUMENTS DIVISION. IT IS NOT TO BE
 REPRODUCED OR TRANSMITTED IN ANY
 MANNER TO OTHERS WITHOUT AUTHORITY.
 TITLE: SERVICE DIAGRAM, COMBINED (4-tube)
 MODEL: BLUES JUNIOR
 CHECKED BY: *[Signature]*
 DATE: 11/16/63
 APPROVED BY: *[Signature]*
 DRAWN: D. LEWIS (ENR. D. LEWIS)
 DATE: 05/27/50
 DATABASE FEE: 2488SCH
 SHEET: 1 OF 2

- NOTES: (UNLESS OTHERWISE NOTED)
1. ALL RESISTORS UNLESS OTHERWISE NOTED.
 2. ALL CAPACITORS UNLESS OTHERWISE NOTED.
 3. ALL DIMENSIONS UNLESS OTHERWISE NOTED.
 4. ALL DIMENSIONS ARE IN INCHES.
 5. THE SCHEMATIC IS FOR THE 6BE6/6X4 VERSION.
 6. LATEST REFERENCE DATA FOR THE 6BE6/6X4 TUBE.
 7. AC AND DC VALUES ARE WITH RESPECT TO GROUND UNLESS OTHERWISE NOTED.
 8. THE 6X4 TUBE MAY BE REPLACED BY THE 6X4P TUBE.
 9. THE 6BE6 TUBE MAY BE REPLACED BY THE 6BE6P TUBE.
 10. THE 6BE6P TUBE IS AVAILABLE IN THE 6BE6P/6X4P KIT.
 11. THE 6BE6P/6X4P KIT IS AVAILABLE IN THE 6BE6P/6X4P KIT.
 12. THE 6BE6P/6X4P KIT IS AVAILABLE IN THE 6BE6P/6X4P KIT.

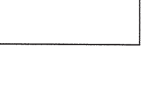
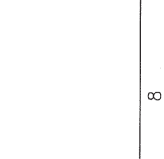
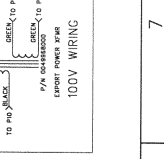
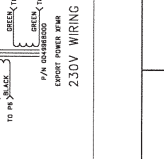
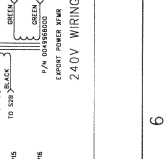
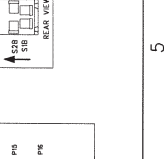
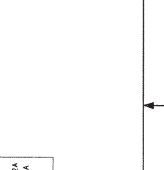
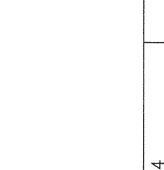

1 2 3 4 5 6 7 8

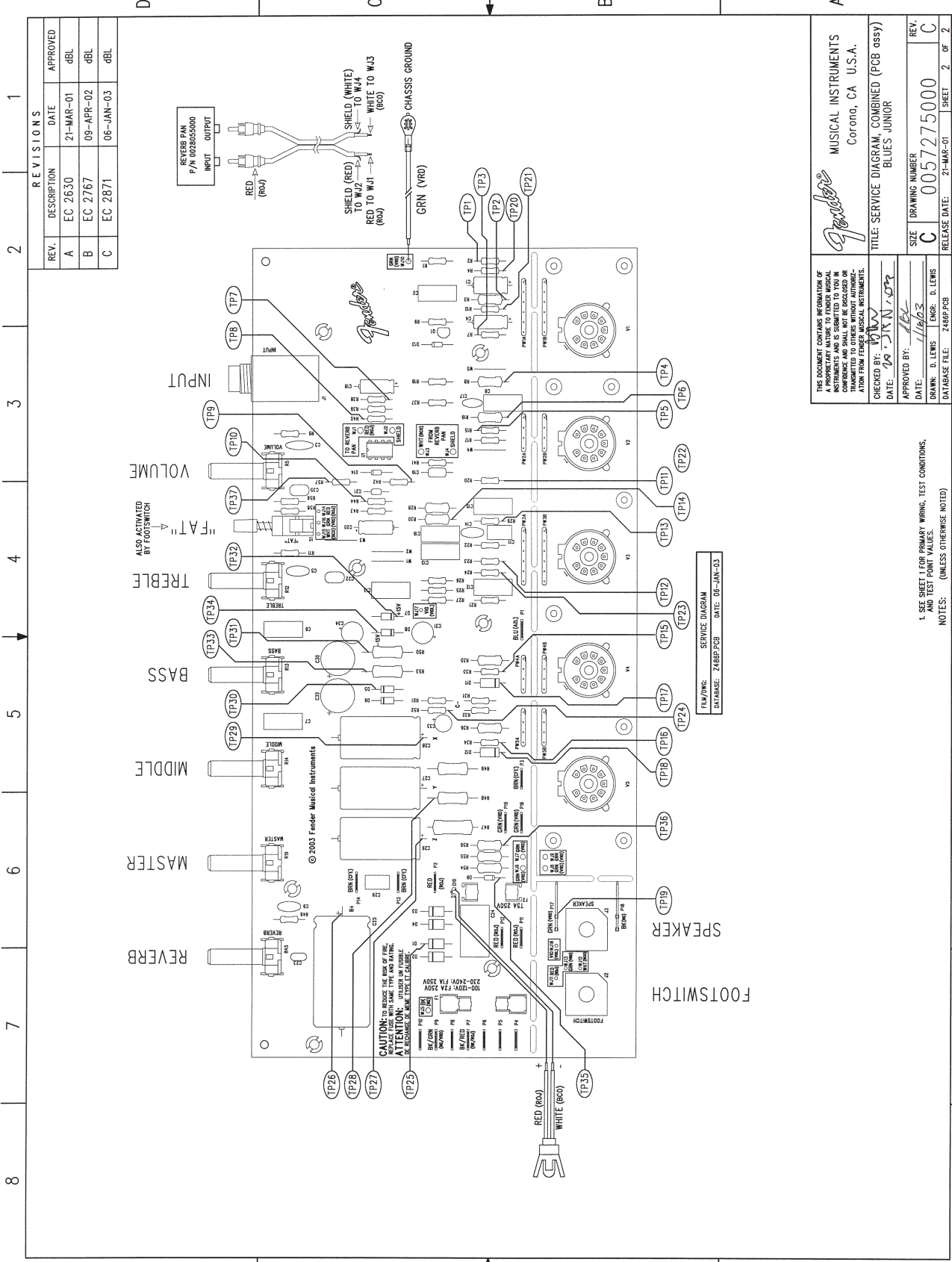

REVISIONS			
REV.	DESCRIPTION	DATE	APPROVED
A	EC 2630	21-MAR-01	dBL
B	EC 2767	09-APR-02	dBL
C	EC 2871	06-JAN-03	dBL

MUSICAL INSTRUMENTS
 Corona, CA U.S.A.
 TITLE: SERVICE DIAGRAM, COMBINED (PCB assy)
 BLUES JUNIOR

THIS DOCUMENT CONTAINS INFORMATION OF A PROPRIETARY NATURE TO FENDER MUSICAL INSTRUMENTS. IT IS TO BE USED FOR SERVICE PURPOSES ONLY AND SHALL NOT BE REPRODUCED OR TRANSMITTED TO OTHERS WITHOUT AUTHORIZATION FROM FENDER MUSICAL INSTRUMENTS.

CHECKED BY: *WJN*
 DATE: *12/21/03*

APPROVED BY: *WJN*
 DATE: *1/16/03*

DRAWN: D. LEWIS ENGR: D. LEWIS
 DATABASE FILE: 2486P.PCB

1. SEE SHEET FOR PRIMARY WIRING, TEST CONDITIONS, AND TEST POINT VALUES.
 NOTES: (UNLESS OTHERWISE NOTED)

SERVICE DIAGRAM
 DRAWING: 2486P.PCB DATE: 08-JAN-03