



GT65/212

Three-channel Guitar Amplifiers



Owner's Manual

TABLE OF CONTENTS:

Introduction 3













The Front Panel 4

The Rear Panel 5

Suggested Settings 6

System Block Diagram 7

Technical Specifications back cover

 <p>CAUTION RISK OF ELECTRIC SHOCK DO NOT OPEN</p>  <p><small>WARNING: TO REDUCE THE RISK OF FIRE OR ELECTRIC SHOCK, DO NOT EXPOSE THIS APPARATUS TO RAIN OR MOISTURE. TO REDUCE THE RISK OF ELECTRIC SHOCK, DO NOT REMOVE COVER. NO USER-SERVICEABLE PARTS INSIDE. REFER SERVICING TO QUALIFIED SERVICE PERSONNEL.</small></p>	 <p>PRECAUCION RIESGO DE CORRIENTAZO NO ABRA</p>  <p><small>PRECAUCION: PARA REDUCIR EL RIESGO DE INCENDIOS O DESCARGAS ELECTRICAS, NO PERMITA QUE ESTE APARATO QUEDE EXPUESTO A LA LLUVIA O LA HUMEDAD. PARA DISMINUIR EL RIESGO DE CORRIENTAZO, NO ABRA LA CUBIERTA. NO HAY PIEZAS ADENTRO QUE EL USUARIO PUEDE REPARAR DEJE TODO MANTENIMIENTO A LOS TECNICOS CALIFICADOS.</small></p>	 <p>ATTENTION RISQUE D'ELECTROCUTION NE PAS OUVRIR</p>  <p><small>ATTENTION: PROTEGEZ CET APPAREIL DE LA PLUIE ET DE L'HUMIDITE AFIN D'EVITER TOUT RISQUE D'INCENDIE OU D'ELECTROCUTION. POUR REDUIRE D'ELECTROCUTION NE PAS ENLEVER LE COUVERCLE. AUCUNE PIECE INTERNE N'EST REPARABLE PAR L'UTILISATEUR. POUR TOUTE REPARATION, S'ADRESSER A UN TECHNICIEN QUALIFIE.</small></p>
<p>IMPORTANT SAFETY INSTRUCTIONS</p> <ul style="list-style-type: none"> • READ, FOLLOW, HEED, AND KEEP ALL INSTRUCTIONS AND WARNINGS. • DO NOT OPERATE NEAR ANY HEAT SOURCE AND DO NOT BLOCK ANY VENTILATION OPENINGS ON THIS APPARATUS. FOR PROPER OPERATION, THIS UNIT REQUIRES 3" (75mm) OF WELL VENTILATED SPACE AROUND HEATSINKS AND OTHER AIR FLOW PROVISIONS IN THE CABINET. • DO NOT USE THIS APPARATUS NEAR SPLASHING, FALLING, SPRAYING, OR STANDING LIQUIDS. • CLEAN ONLY WITH LINT-FREE DAMP CLOTH AND DO NOT USE CLEANING AGENTS. • ONLY CONNECT POWER CORD TO A POLARIZED, SAFETY GROUNDED OUTLET WIRED TO CURRENT ELECTRICAL CODES AND COMPATIBLE WITH VOLTAGE, POWER, AND FREQUENCY REQUIREMENTS STATED ON THE REAR PANEL OF THE APPARATUS. • PROTECT THE POWER CORD FROM DAMAGE DUE TO BEING WALKED ON, PINCHED, OR STRAINED. • UNPLUG THE APPARATUS DURING LIGHTNING STORMS OR WHEN UNUSED FOR LONG PERIODS OF TIME. • ONLY USE ATTACHMENTS, ACCESSORIES, STANDS, OR BRACKETS SPECIFIED BY THE MANUFACTURER FOR SAFE OPERATION AND TO AVOID INJURY. • WARNING: TO REDUCE THE RISK OF ELECTRIC SHOCK OR FIRE, DO NOT EXPOSE THIS UNIT TO RAIN OR MOISTURE.. • SERVICE MUST BE PERFORMED BY QUALIFIED PERSONNEL. • OUR AMPLIFIERS ARE CAPABLE OF PRODUCING HIGH SOUND PRESSURE LEVELS. CONTINUED EXPOSURE TO HIGH SOUND PRESSURE LEVELS CAN CAUSE PERMANENT HEARING IMPAIRMENT OR LOSS. USER CAUTION IS ADVISED AND EAR PROTECTION IS RECOMMENDED IF UNIT IS OPERATED AT HIGH VOLUME. 		
<p>EXPLANATION OF GRAPHICAL SYMBOLS:  = "DANGEROUS VOLTAGE"  = "IT IS NECESSARY FOR THE USER TO REFER TO THE INSTRUCTION MANUAL"</p> <p>EXPLICACION DE SIMBOLOS GRAFICOS:  = "VOLTAJE PELIGROSO"  = "ES NECESARIO QUE EL USUARIO SE REFIERA AL MANUAL DE INSTRUCCIONES."</p> <p>EXPLICATION DES SYMBOLES GRAPHIQUES:  = "DANGER HAUTE TENSION"  = "REFERREZ-VOUS AU MANUAL D'UTILISATION"</p>		

Congratulations!

You are now the proud owner of the Crate GT65/212 three-channel guitar amplifier. This rugged amplifier combines outstanding features with serious clean and distorted sounds. Front panel RCA input jacks allow you to play along with your favorite CD or tape. The rear panel Insert Jack allows you to connect your effects for greater flexibility. Channel switching and reverb may be controlled by means of a footswitch.

Like all Crate products, your GT amplifier is designed by musicians, and built using only the best components. Extensive testing confirms that this amplifier is the absolute best it can be.

In order to get the most out of your new amplifier, we strongly urge you to read the information contained in this manual before you begin playing.

And **thank you** for choosing Crate.

Declaration Of Conformity

#30, Effective 01-01-2001

Manufacturer's Name:	SLM Electronics
Production Facility:	11880 Borman Drive, St. Louis, MO 63146, USA
Production Facility:	700 Hwy 202 W, Yellville, AR 72687, USA
Shipping Facility:	1400 Ferguson Ave., St. Louis, MO 63133, USA
Office Facility:	1400 Ferguson Ave., St. Louis, MO 63133, USA
Product Type:	Audio Amplifier
Complies with Standards:	
LVD:	92/31/EEC, 93/68/EEC, & 73/23/EWG
Safety:	EN60065
EMC:	EN55013, EN55020, EN55022, EN61000-3-2, & EN61000-3-3

Supplementary information provided by:
SLM Electronics - R & D Engineering
1901 Congressional Drive, St Louis, MO 63146, USA
Tel.: 314-569-0141, Fax: 314-569-0175

The Front Panel:

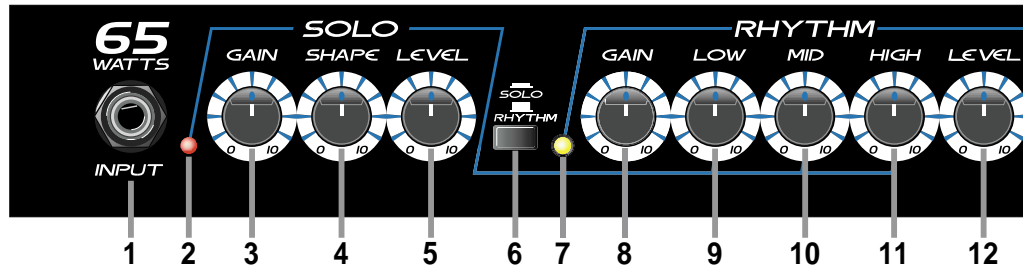

1: INPUT: Use this jack to connect your guitar to the amplifier by means of a shielded instrument cable.

SOLO/RHYTHM CHANNELS: *High gain channels giving you sounds with serious overdrive.*

2: SOLO LED: This LED illuminates when the Solo channel is selected.

3: GAIN: Use this control to adjust the amount of distortion produced by the Solo channel.

4: SHAPE: Use this control to “dial in” the tone for the Solo channel. Rotating the control counterclockwise enhances the mid frequencies, while rotating the control clockwise enhances the low and high frequencies.

5: LEVEL: Use this control to adjust the output level of the Solo channel.

6: SOLO/RHYTHM SELECT: Use this switch to select the Solo or Rhythm channel. When this switch is depressed, the Solo channel is selected. With the switch in the out position, the Rhythm channel is selected. This switch is active only when the Solo-Rhythm/Clean Select switch (#13) is depressed.

7: RHYTHM LED: This LED illuminates when the Rhythm channel is selected.

8: GAIN: Use this control to adjust the amount of distortion produced by the Rhythm channel.

9: LOW: Use this control to adjust the low frequency level of the Solo/Rhythm channel.

10: MID: Use this control to adjust the midrange frequency level of the Solo/Rhythm channel.

11: HIGH: Use this control to adjust the high frequency level of the Solo/Rhythm channel.

12: LEVEL: Use this control to adjust the output level of the Rhythm channel.

13: SOLO-RHYTHM/CLEAN SELECT: Use this switch to select the Clean channel or the Solo and Rhythm channels. With the switch in the out position, the Clean channel is selected. When the switch is depressed, either the Solo or Rhythm channel is selected, depending on the setting of the Solo/ Rhythm Select switch (#6).

CLEAN CHANNEL: *A normal gain channel designed to give you crystal clean sounds.*

14: CLEAN LED: This LED illuminates when the Clean channel is selected.

15: VOL: Use this control to adjust the output level of the Clean channel.

16: LOW: Use this control to adjust the low frequency level of the Clean channel.

17: MID: Use this control to adjust the midrange frequency level of the Clean channel.

18: HIGH: Use this control to adjust the high frequency level of the Clean channel.

19: REVERB: Use this control to adjust the amount of reverb effect: in its fully counterclockwise position the signal will be “dry” (without any effect). As you rotate the control clockwise the amount of reverb increases.

20: CD INPUT: Use these RCA jacks to connect the output from a CD player or tape deck to the amplifier. The signal at these jacks is combined into a mono signal which is sent to the internal power amp circuit. Use the CD or tape player’s output level control to adjust the signal for the proper mix with your guitar.

CRATE GT65/212 Guitar Amplifier

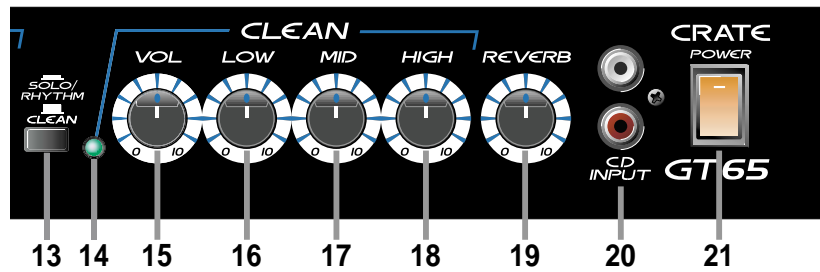

21: POWER: Use this switch to turn the amplifier on (top of the switch depressed) and off (bottom of the switch depressed). The switch illuminates when the power is on.

The Rear Panel:

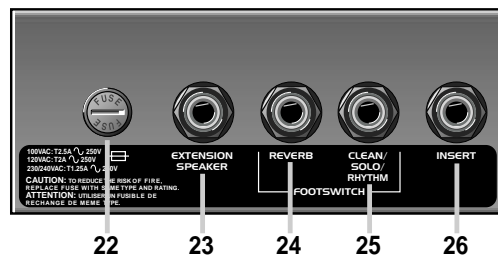

22: FUSE: The fuse protects the amplifier from damages caused by a faulty AC power source and/or other problems. If the fuse opens, replace it **ONLY** with the same size and type. If fuses continue to fail, check the AC source – if the source is okay, contact your Crate dealer for service information.

23: EXTENSION SPEAKER: Use this jack to connect the amplifier to an external speaker cabinet. This jack is wired in series with the internal speaker(s) which remain active when an extension speaker is connected.

24: REVERB FOOTSWITCH: Use this jack to connect the 1/4" mono plug on the footswitch cable to the three-button footswitch (supplied). This allows you to remotely turn the reverb on and off.

25: CLEAN/SOLO/RHYTHM FOOTSWITCH: Use this jack to connect the 1/4" stereo plug on the footswitch cable to the three-button footswitch (supplied). This allows you to remotely switch between the Clean and Distortion channels and between the Solo and Rhythm channels.

26: INSERT: Use this jack to connect an external effects device to the amplifier. Use Crate's STP201, STP202, or STP203 stereo-to-mono Y-cord or an adapter such as Crate's YPP117 and two 1/4" mono signal cables to connect to the effect as shown to the immediate right.

27: AC LINE CORD (not shown): This grounded power cord is to be plugged into a grounded power outlet, wired to current electrical codes and compatible with the voltage, power, and frequency requirements stated on the rear panel. **Do not attempt to defeat the safety ground connection.**

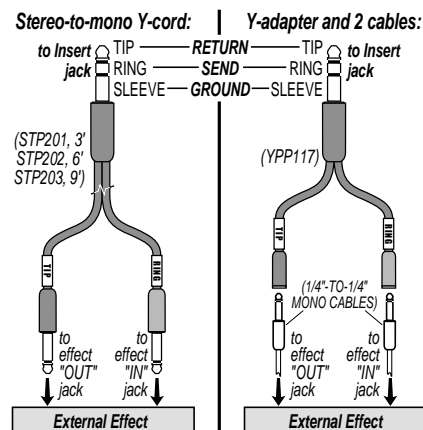

CRATE GT65/212 Guitar Amplifier

Suggested Settings:

Sweet 'n Clean:

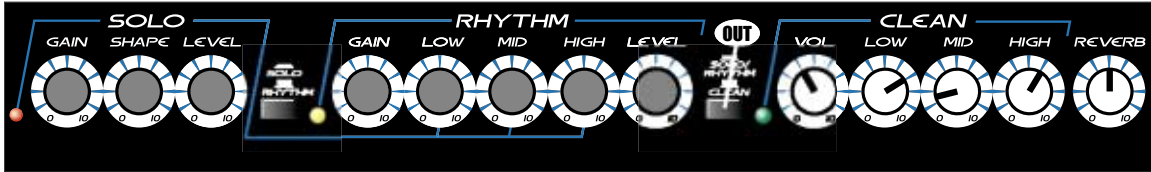

Just a 'Lil Nasty:

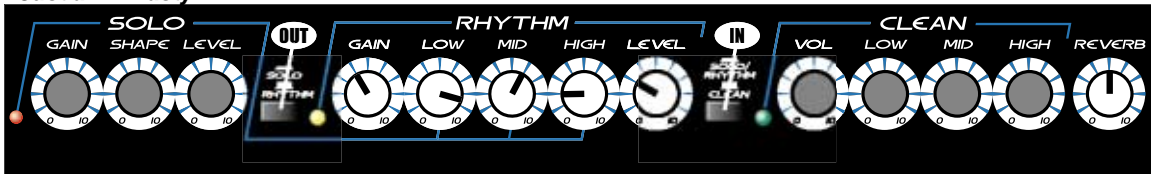

Politely Gritty:

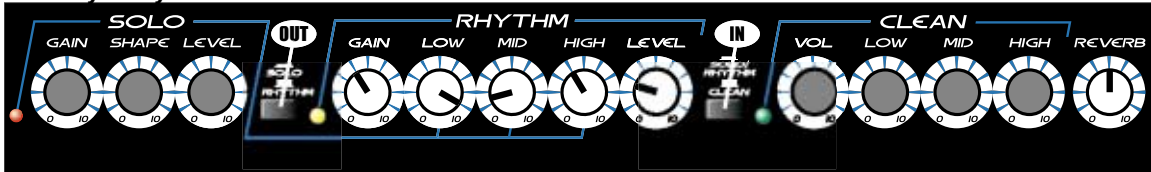

Down 'n Dirty:

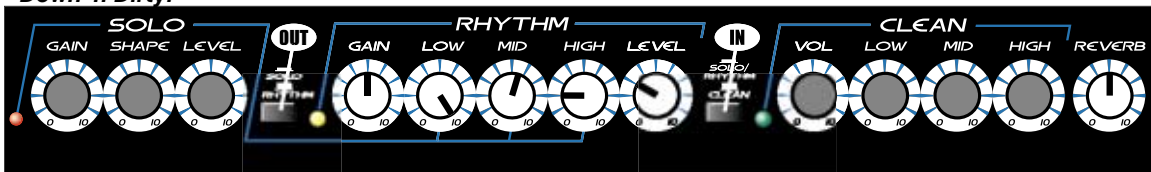

Mean & Obscene:

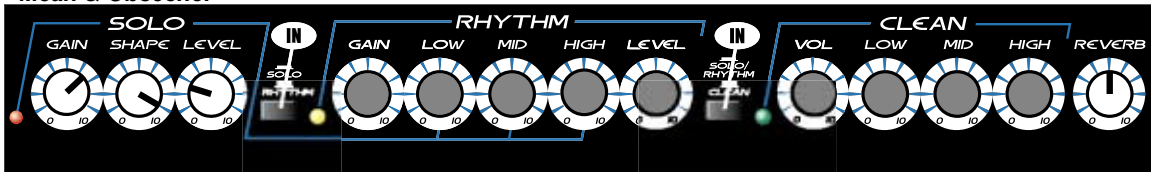

System Block Diagram:

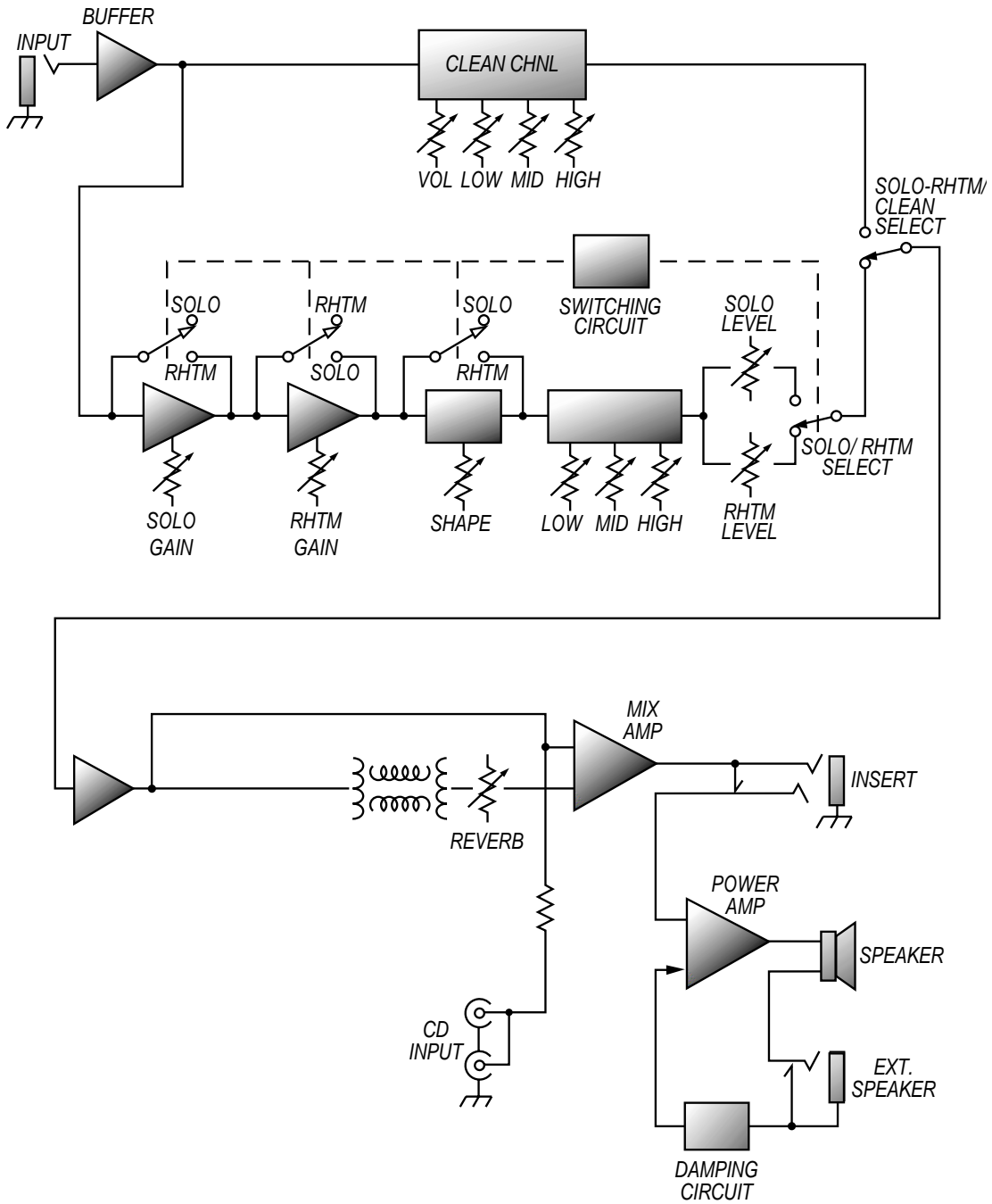

CRATE **GT65/212** Guitar Amplifier

GT65/212 TECHNICAL SPECIFICATIONS:

Output Power Rating	GT65	65W RMS @ 5% THD, 8Ω, 120 VAC
	GT212	120W RMS @5% THD, 4Ω, 120 VAC
Speaker Size and Rating	GT65	(1) Custom Design 12", 8Ω
	GT212	(2) Custom Design 12", 8Ω
Input Impedance		470kΩ
Total System Gain	Solo Ch	110dB, all controls @10
	Rhythm Ch	88dB, all controls @10
	Clean Ch	58dB, all controls @10
CD Input		29dB
Maximum Input Signal Accepted		7 volts peak-to-peak
Solo Channel	Shape Control	Proprietary Circuit
Rhythm Channel	Low Control	20dB range @ 80Hz
	Mid Control	15dB range @ 1kHz
	High Control	20dB range @ 10kHz
Clean Channel	Low Control	36dB range @ 80Hz
	Mid Control	15dB range @ 800Hz
	High Control	40dB range @ 10kHz
Power Requirements	GT65	120 VAC, 60Hz, 90VA
		100/115VAC, 50/60Hz, 90VA;
		230VAC, 50/60Hz, 90VA
	GT212	120 VAC, 60Hz, 95VA
		100/115VAC, 50/60Hz, 95VA;
		230VAC, 50/60Hz, 95VA
Size and Weight	GT65	17-1/2" H x 20" W x 11" D, 34 lbs.
	GT212	21" H x 26-1/2" W x 11" D, 50 lbs.

The GT65/212 is covered with a durable Tolex material: wipe it clean with a lint-free cloth. Never spray cleaning agents onto the cabinet. Avoid abrasive cleansers which would damage the finish.

Crate continually develops new products, as well as improves existing ones. For this reason, the specifications and information in this manual are subject to change without notice.



www.crateamps.com

@2002 SLM Electronics, a division of St. Louis Music, Inc • 1400 Ferguson Avenue • St. Louis, MO 63133
47-432-01 • 012903