



LITTLE MARK II
&
COMBO HEAD

SERVICE MANUAL

**Mark
bass**

2005 EDITION

How to Disassemble the Little Mark II & Combo Head Preamp

1. Remove the eight knobs, pulling out as indicated in the picture.

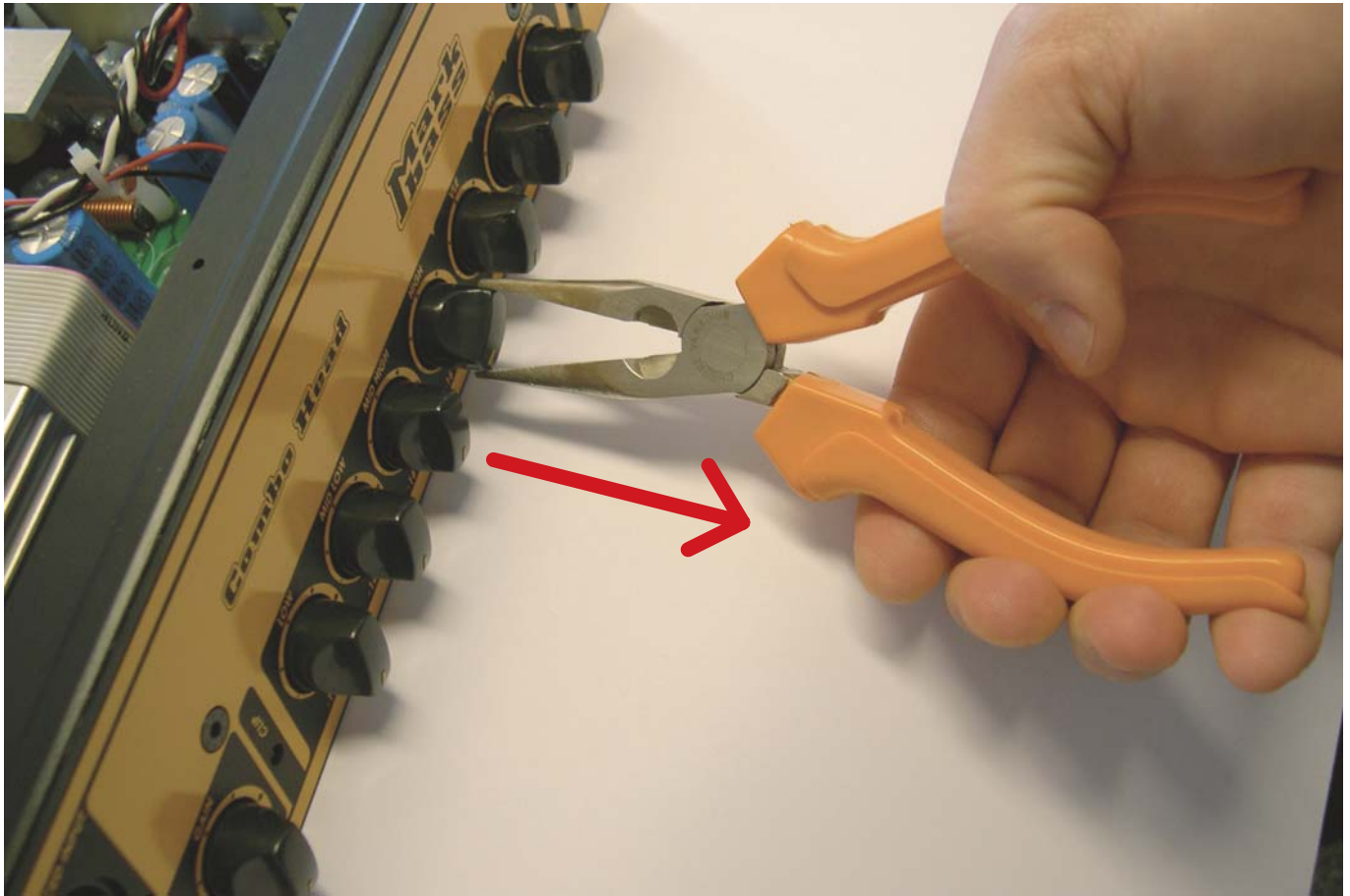

2. Remove the eight silver hexagonal nuts using a 10 or 11 mm nut screwdriver (see white arrow).
3. Remove the black hexagonal nut using a 15 mm nut screwdriver (see red arrow).



How to Disassemble the Little Mark II & Combo Head Preamp

4. Remove the three connectors from the preamp (1-2-3).
5. Remove the three screws (4-5-6).

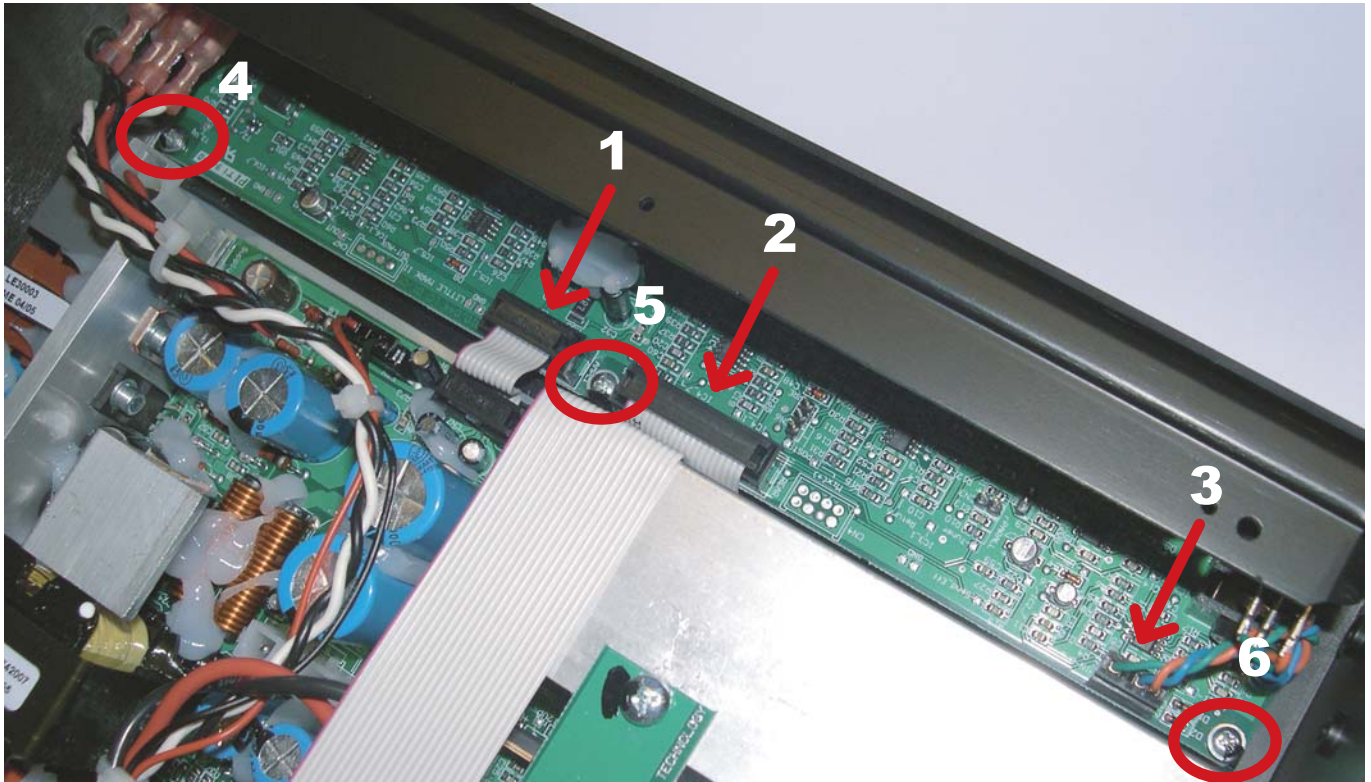

How to Disassemble the Little Mark II & Combo Head Power Amp / Power Supply

1. Remove the four connectors from the power amp / power supply (1-2-3-4).

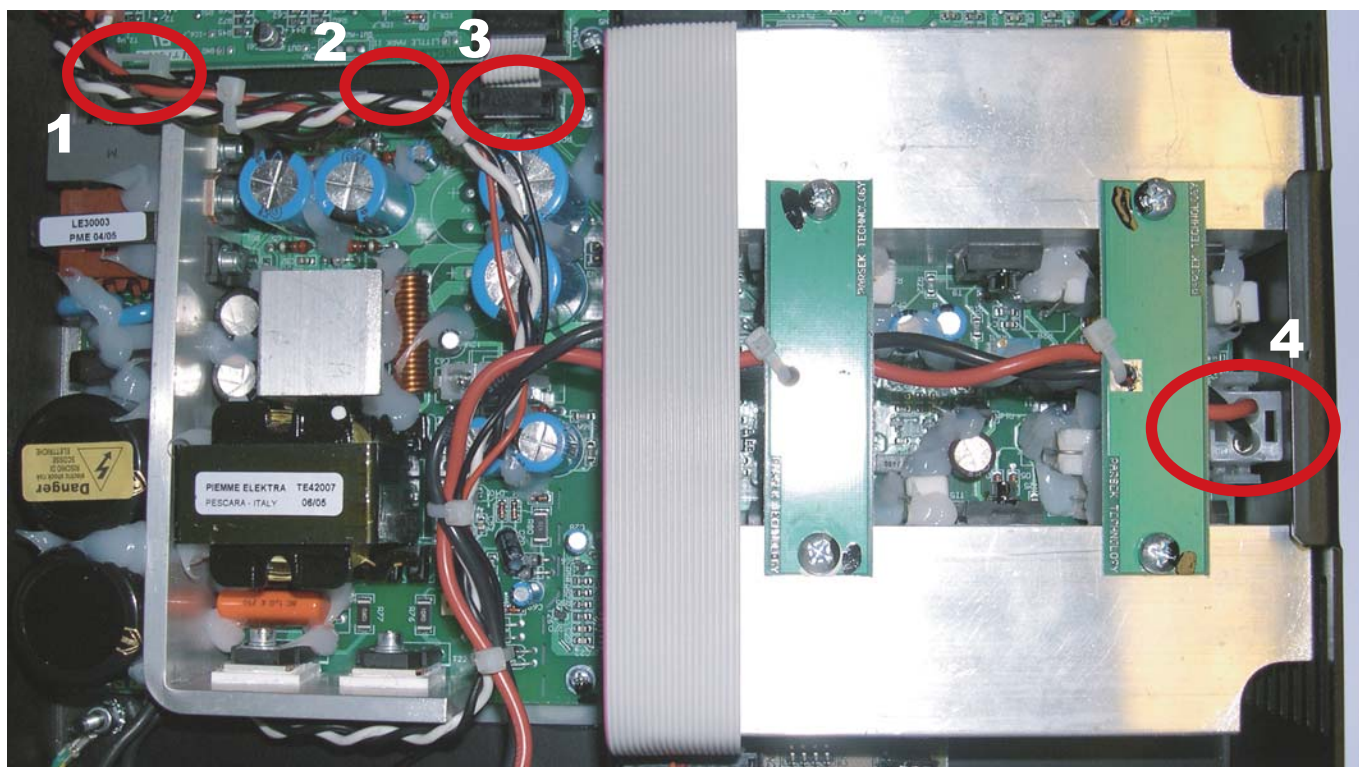

2. Remove the six screws from the power amp / power supply (5-6-7-8-9-10).

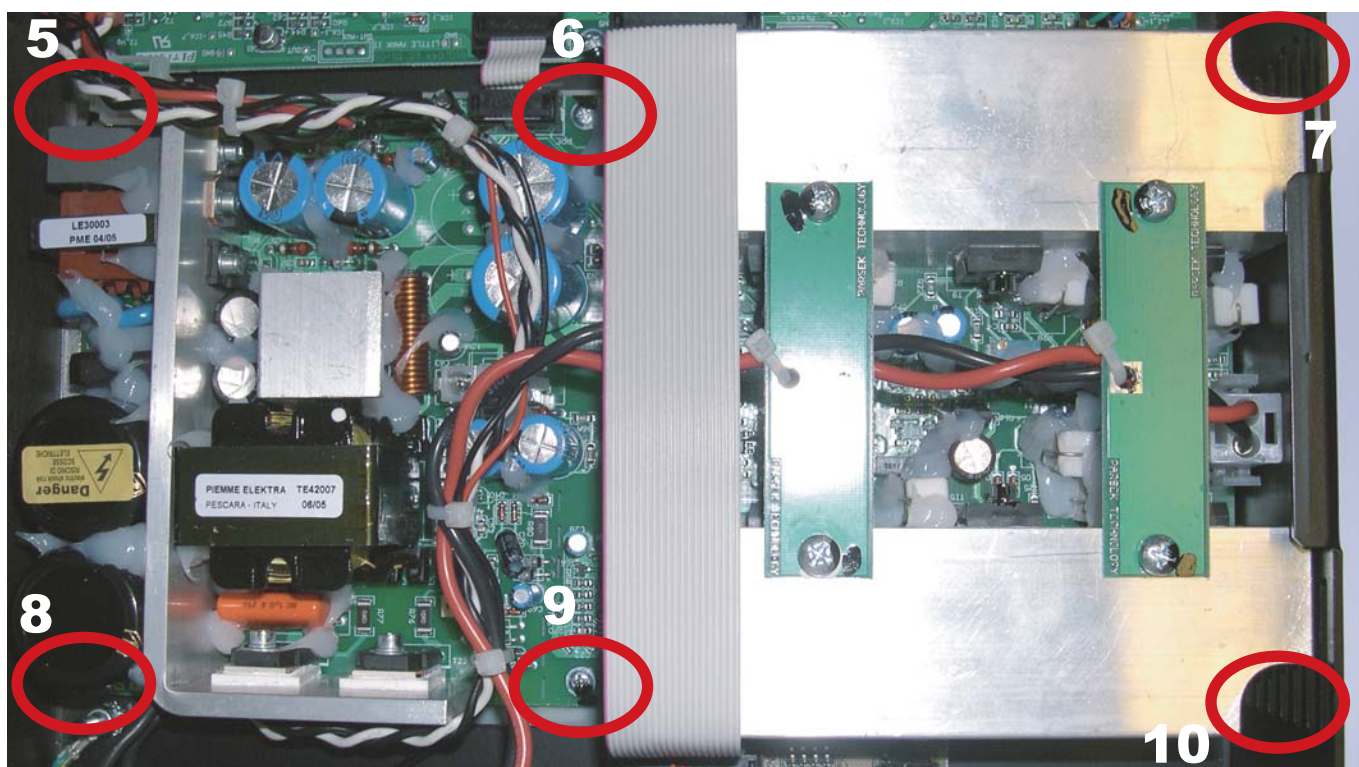

How to Disassemble the Little Mark II & Combo Head Front Panel Components

1. Using a screwdriver, remove the two screws of the balanced input (1-2).
2. Remove the two screws with a 2.5 mm hexagonal wrench (3-4).



3. Remove the connector from the preamp (5).

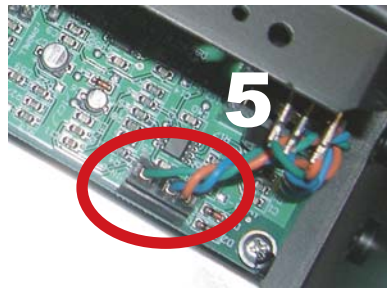

4. Remove the four faston connectors (6).
5. Press on the top (7-8) and bottom (9-10) ends of the power switch to remove it from the panel.

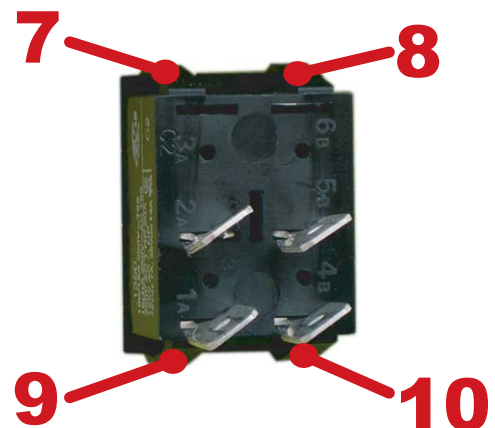
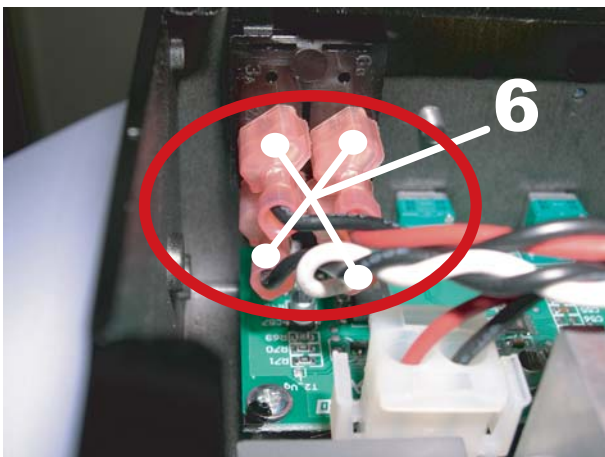

How to Disassemble the Rear Panel Components

1. Using a screwdriver, remove the four screws of the fan (1-2-3-4), the two screws of the speaker out jack (5-6) and the two screws of the line out jack (7-8).
2. Remove the four black hexagonal nuts using a 15 mm nut screwdriver (9-10-11-12).

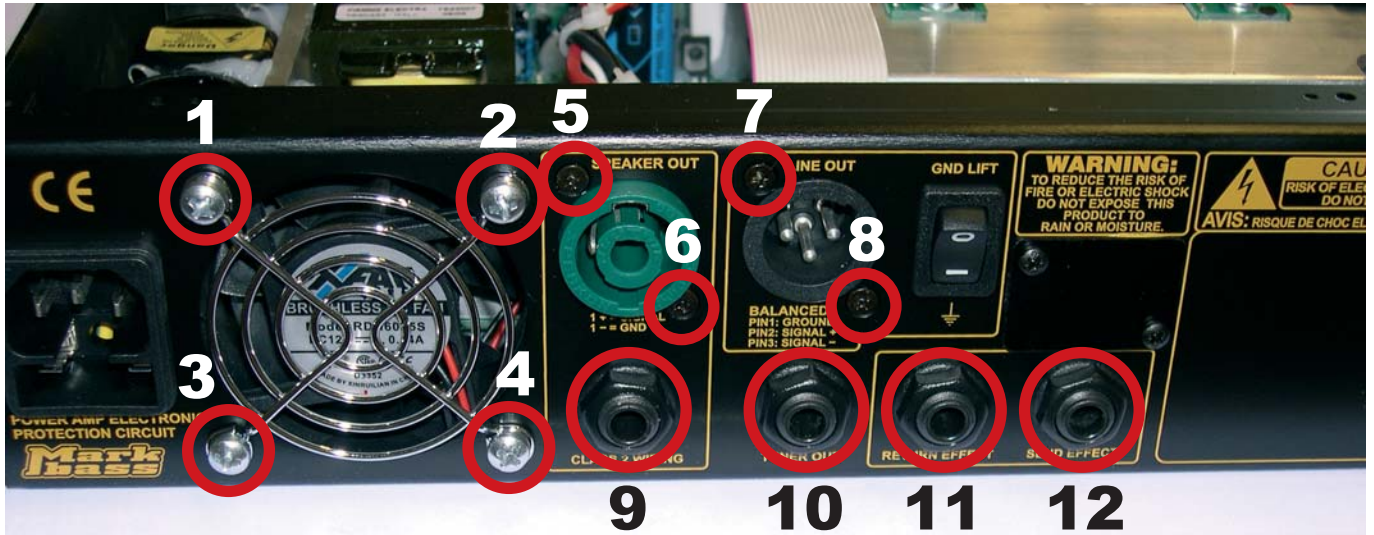

3. Remove the two faston connectors attached to the ground lift switch (13). Then press on the top (14) and bottom (15) ends of the ground lift switch to remove it from the rear panel.
4. Remove the ground hexagonal nut using a 7 mm nut screwdriver (16).

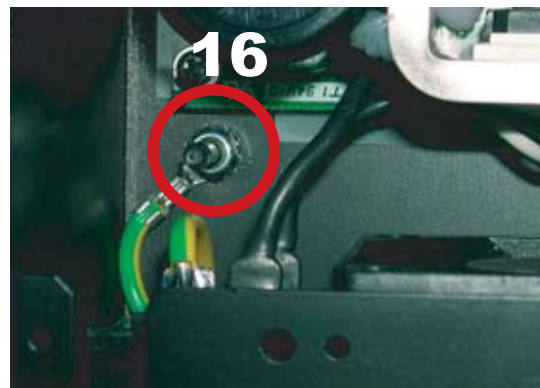
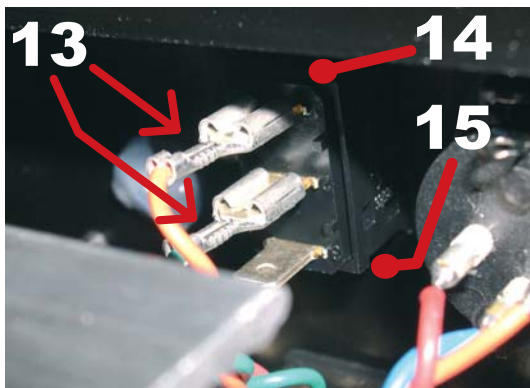

5. Press on the top (17-18) and bottom (19-20) ends of the AC power jack to remove it from the panel.

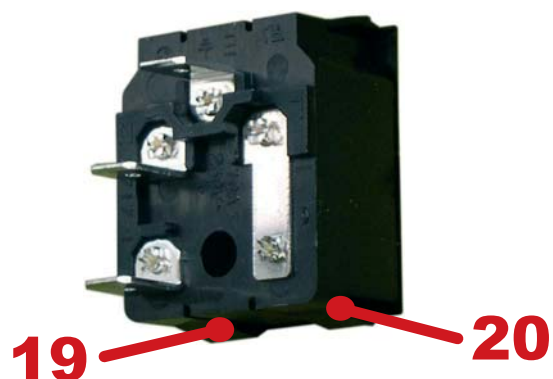
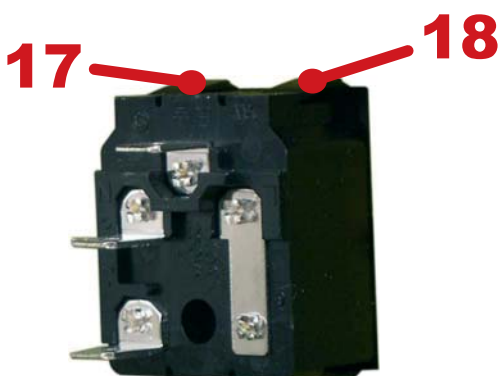

Effects Loop Modification

The images below show how the effects loop in your amp can be modified to run in series. The default factory setting is parallel.

Please note that this modification must be made by qualified Markbass service personnel only.

PARALLEL CONNECTION

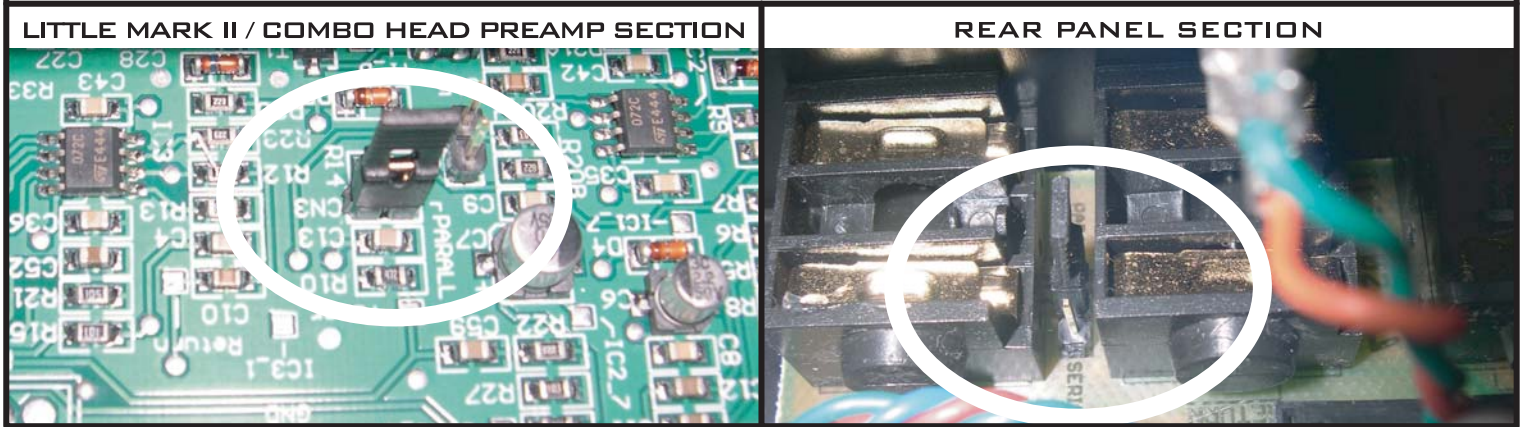

SERIAL CONNECTION

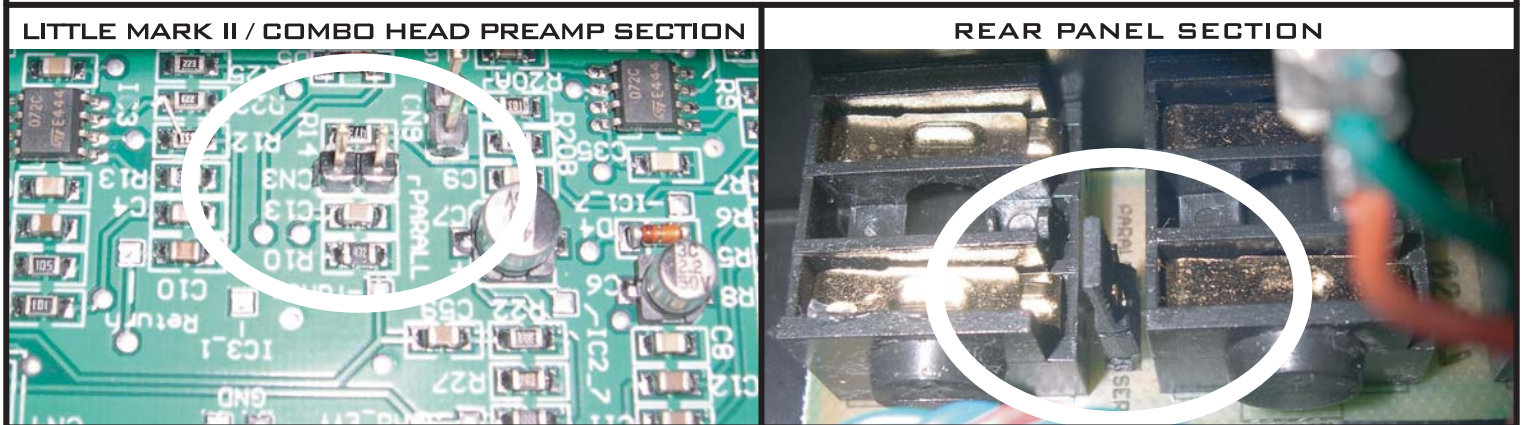

DI Output Modification

The images below show how the DI output in your amp can be modified to run in PRE equalization. The default factory setting is POST-EQ.

Please note that this modification must be made by qualified Markbass service personnel only.

POST-EQ

PRE-EQ

LITTLE MARK II / COMBO HEAD PREAMP SECTION

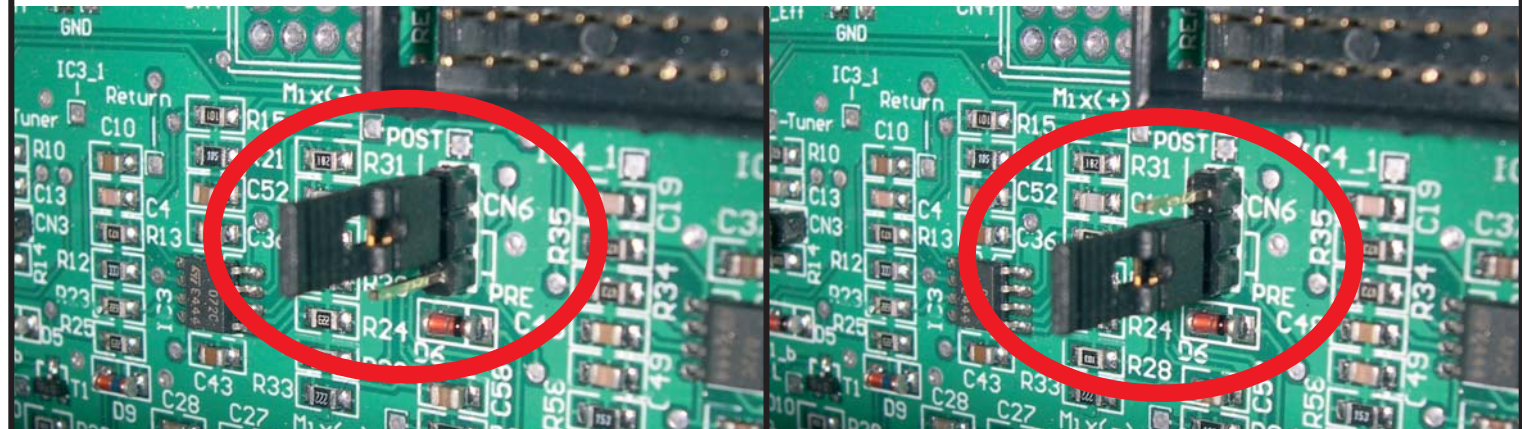

Power Supply Modification

The images below show how your amp can be modified to operate in different countries:

1. EUROPE (230V / 50Hz)
2. UK / AUSTRALIA (240V / 50Hz)
3. USA / CANADA (120V / 60Hz)
4. JAPAN (100V / 50-60Hz)

For detailed information on voltage requirements in other countries, please consult the “International Voltage Chart” included on the CD.

Please note that this modification must be made by qualified Markbass service personnel only.

1. EUROPE MODIFICATION

230V - JP1 open - J3 open - J6 open - J7 closed

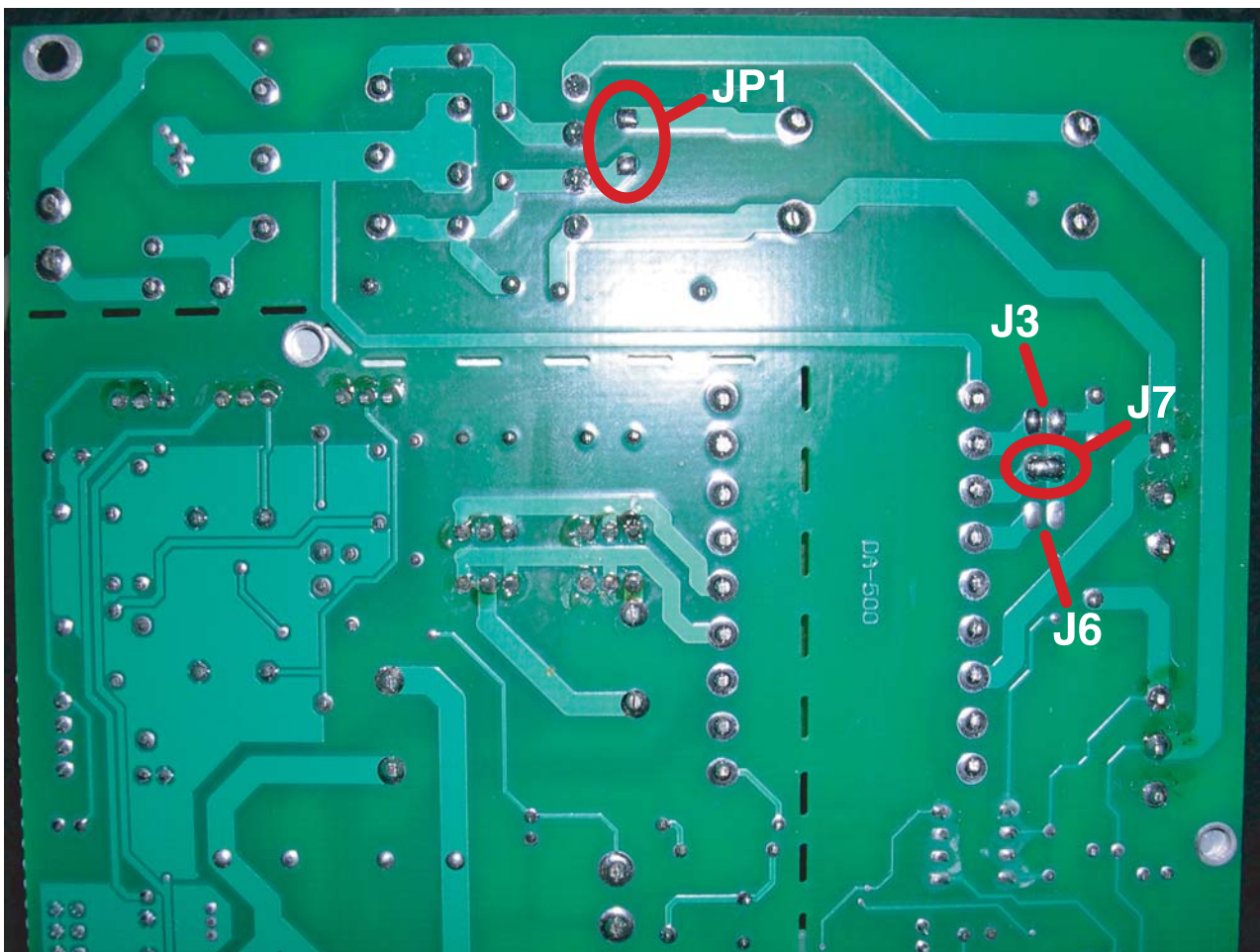

Power Supply Modification

2. UK / AUSTRALIA MODIFICATION

240V - JP1 open - J3 closed - J6 open - J7 open

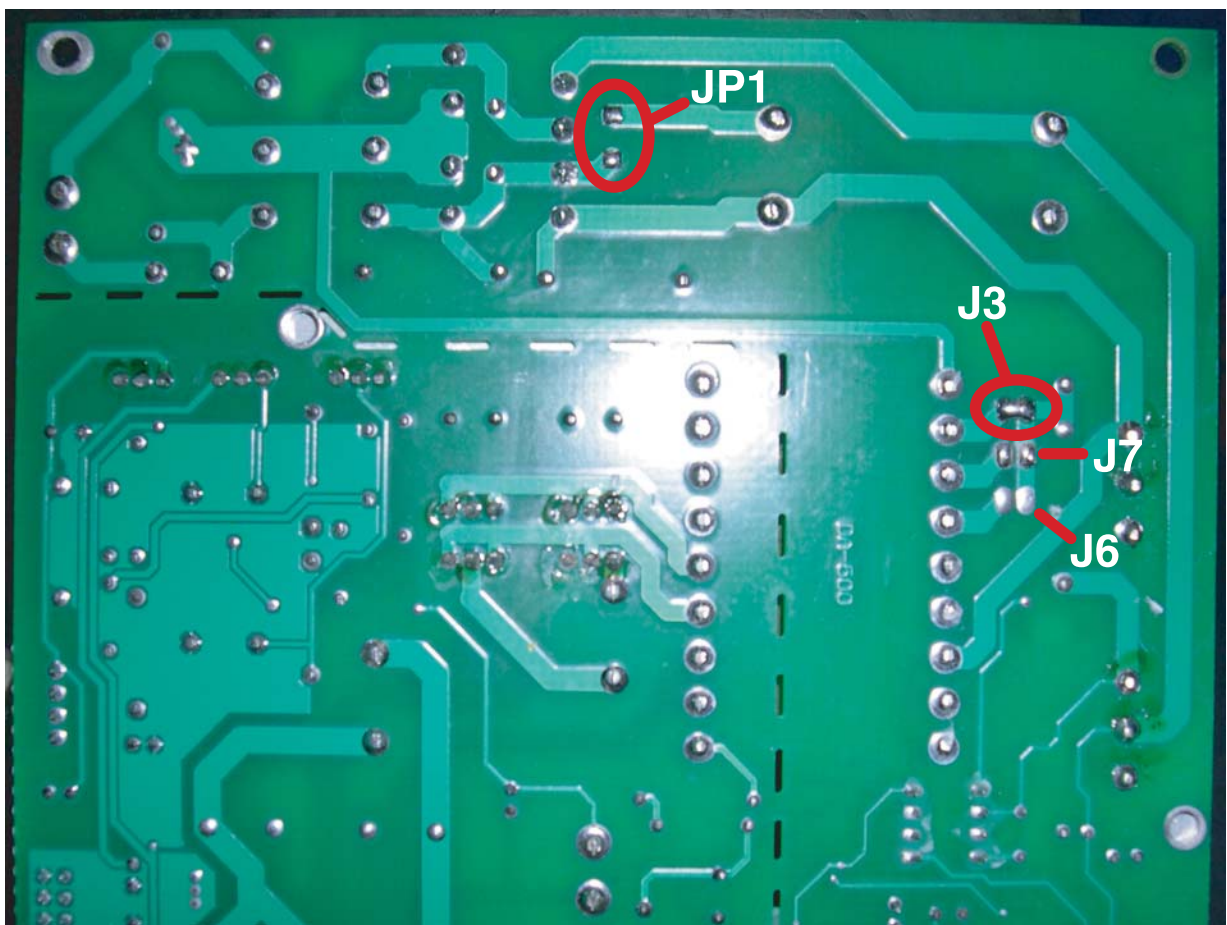

Power Supply Modification

3. USA / CANADA

120V - JP1 closed - J3 closed - J6 open - J7 open

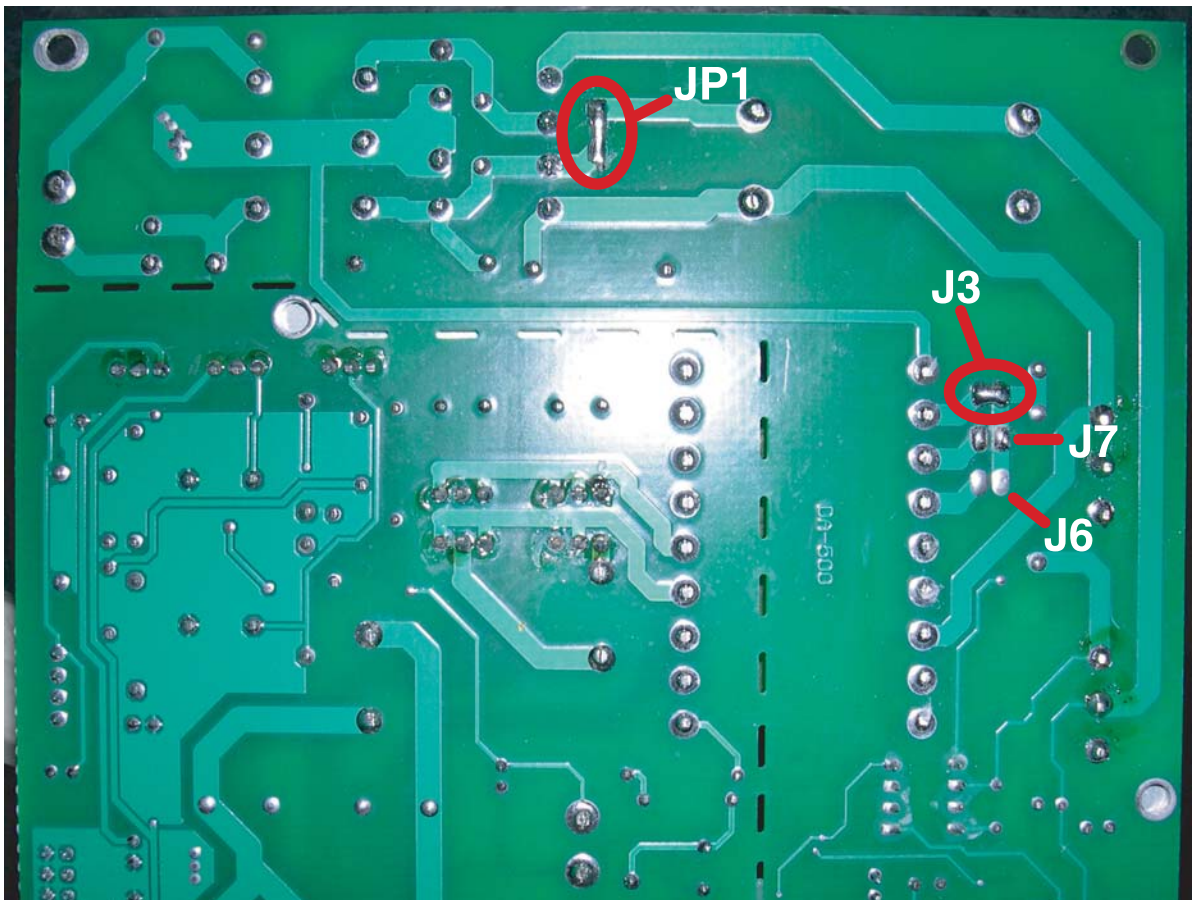



Power Supply Modification

4. JAPAN

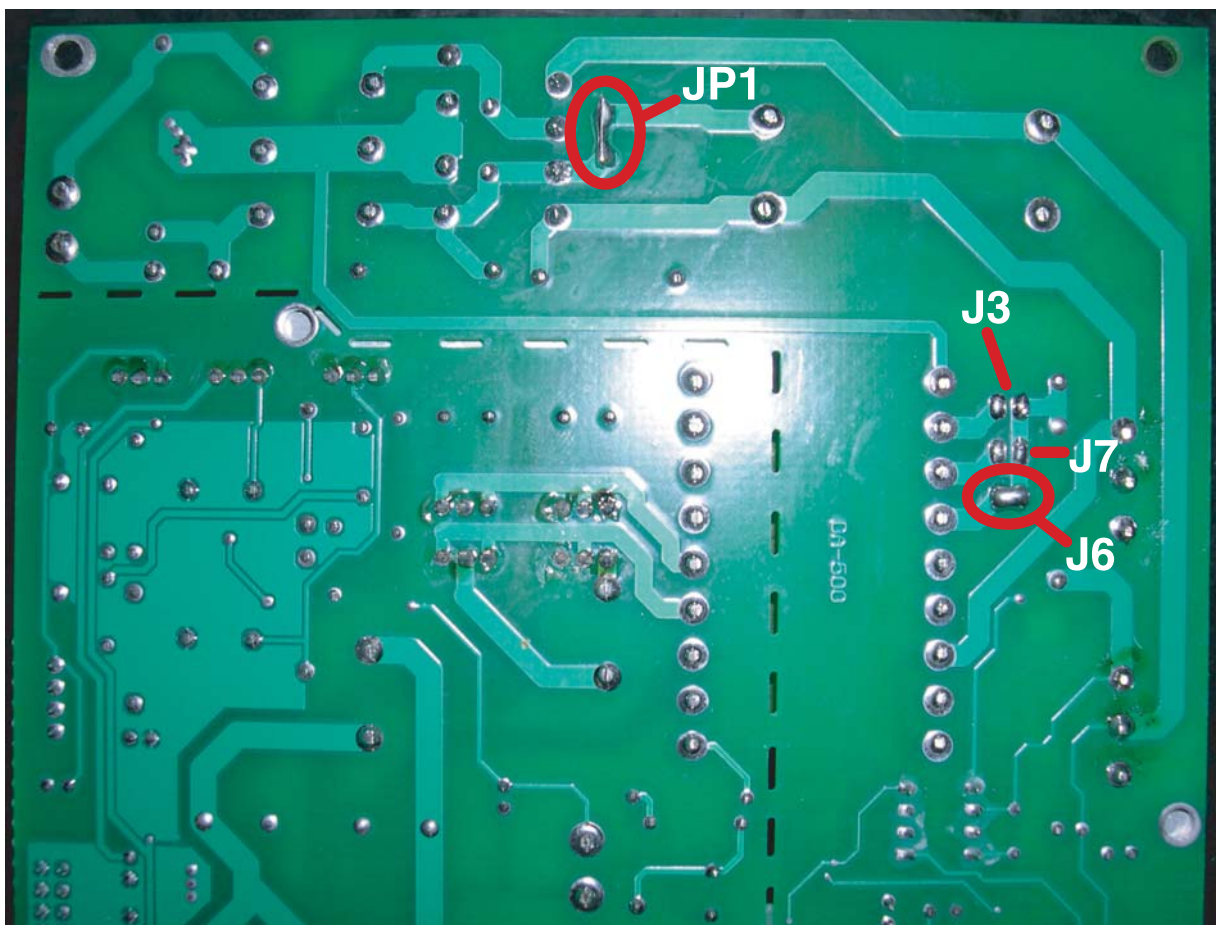
100V - JP1 closed - J3 open - J6 closed - J7 open

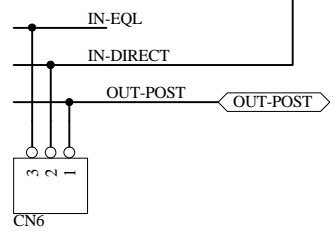
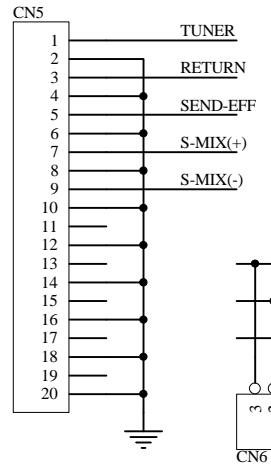
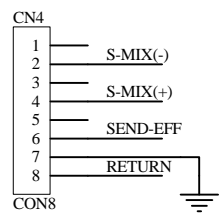
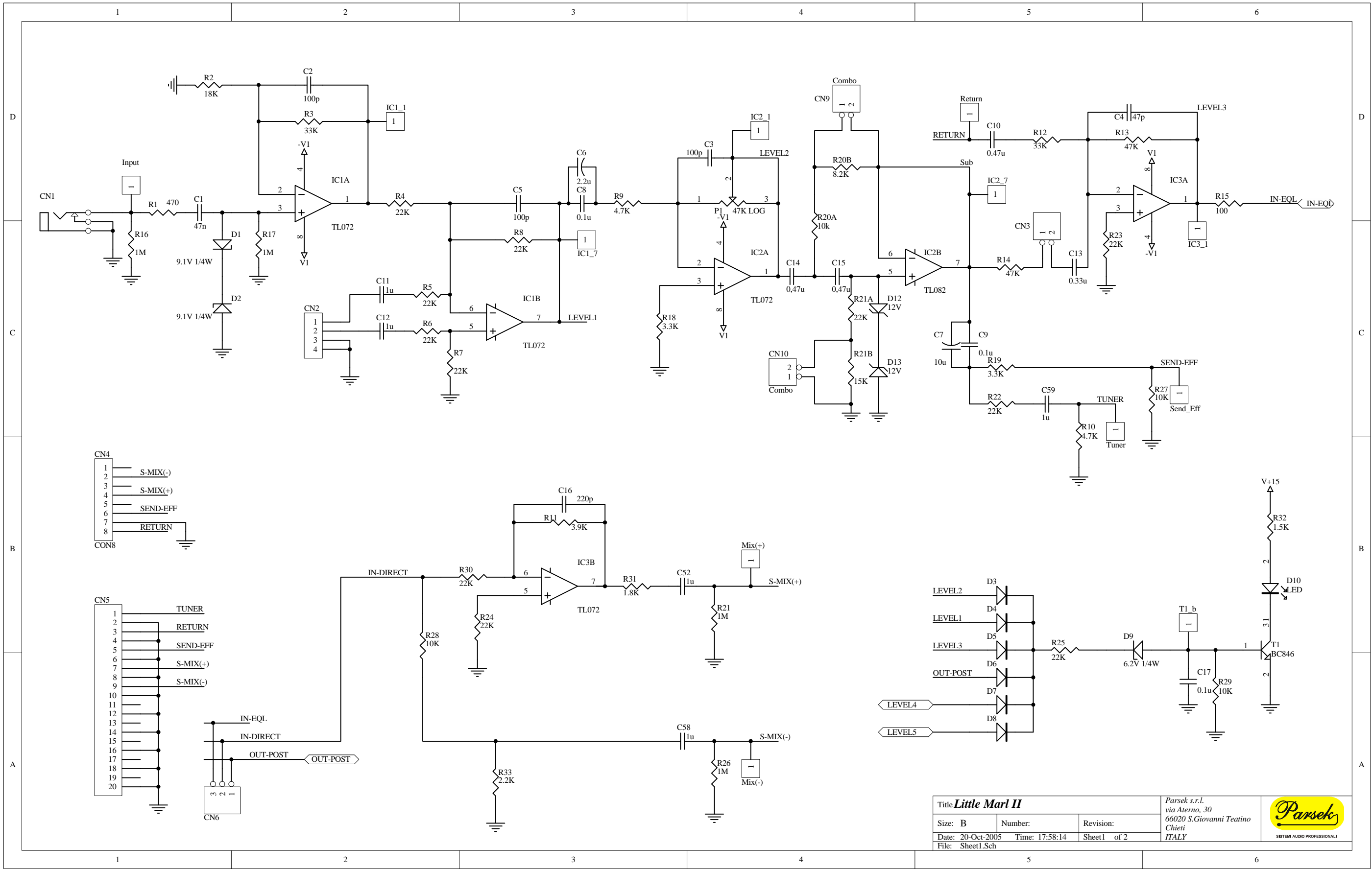



Title Little Marl II			Parsek s.r.l. via Aterno, 30 66020 S.Giovanni Teatino Chieti ITALY	 <small>SYSTEM AUDIO PROFESSIONALI</small>
Size: B	Number:	Revision:		
Date: 20-Oct-2005	Time: 17:58:14	Sheet1 of 2		
File: Sheet1.Sch				

