

Common Power Output Vacuum Tube Pinout Configurations

EL84, 6BQ5
vacuum tube
Pentode

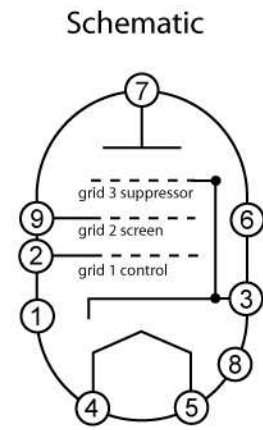

6V6, 6L6, KT66, 6550
vacuum tube
Beam Tetrode

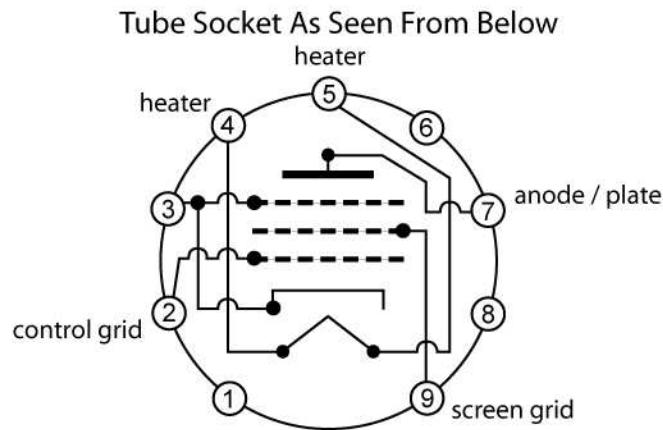
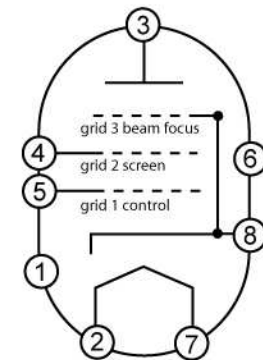
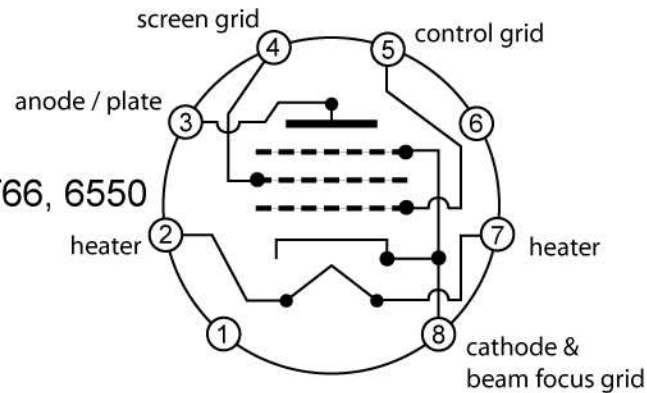

EL34
vacuum tube
Pentode

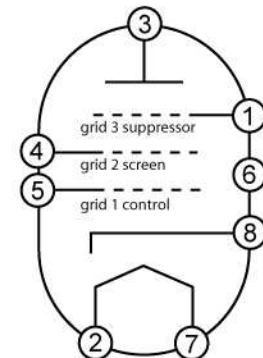
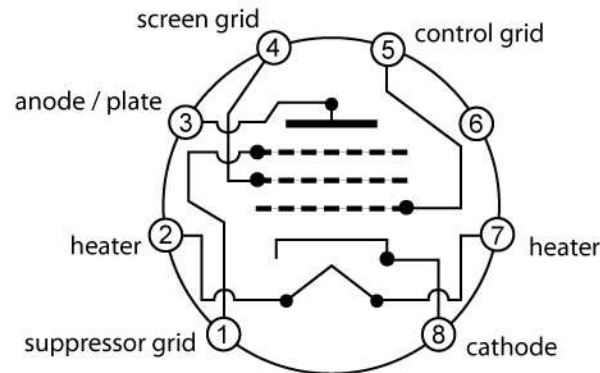

KT88
vacuum tube
Beam Tetrode

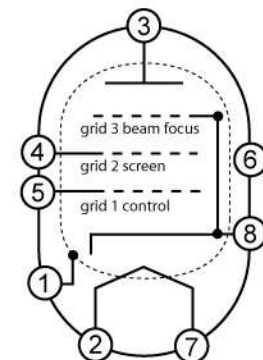
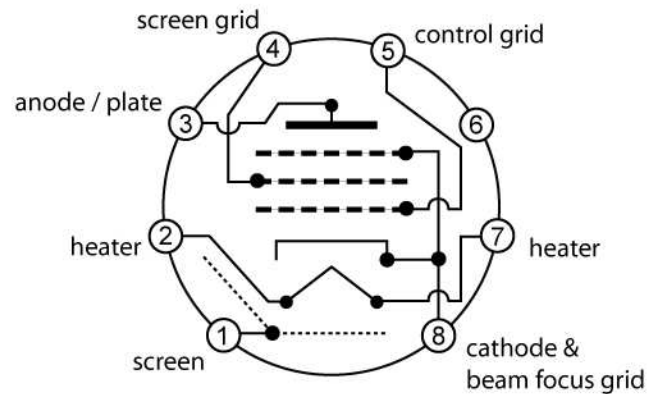

Tube Socket As Seen From Below

Schematic