

Application Note AN-1097

IRS2011 and IR2011 Comparison

By Jason Nguyen, Min Fang, David New

Table of Contents

	Page
Introduction	1
Block Diagram.....	2
Electrical Characteristic Differences.....	3
Figures	3
Summary.....	9

Introduction

The IRS2011 is a new HVIC product that replaces the IR2011 and is pin-to-pin compatible with its predecessor. This application note describes the various differences between the IRS2011 and the IR2011 HVICs.

The IRS2011 is a high power, high speed power MOSFET driver with independent high and low side referenced output channels, ideal for Class D Audio and DC-DC converter applications. Logic inputs are compatible with standard CMOS or LSTTL outputs, down to 3.0 V logic. The output drivers feature a high pulse current buffer stage designed for minimum driver cross-conduction. Propagation delays are matched to simplify its use in high frequency applications. The floating channel can be used to drive an N-channel power MOSFET in the high side configuration which operates up to 200 V. Proprietary HVIC and latch immune CMOS technologies enable ruggedized monolithic construction.

Block Diagram

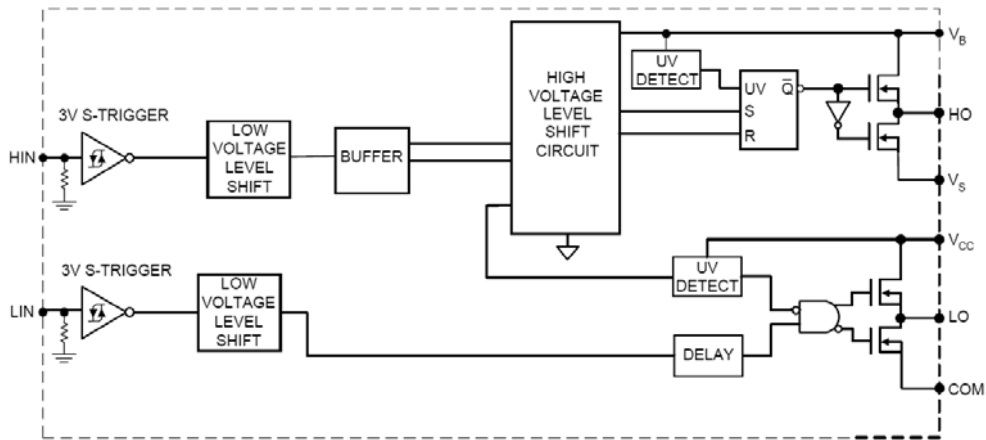

The IRS2011 and IR2011 share the same block diagram. The functionality of the two ICs is the same.

Electrical Characteristic Differences

All measurement conditions remain unchanged unless noted. Parameters not mentioned have not changed.

Absolute Maximum Ratings

Parameter		IR2011		IRS2011		Units
Symbol	Definition	min	max	min	max	
V_B	High side floating supply voltage	-0.3	225	-0.3	220 (Note1)	V
V_S	High side floating supply offset voltage	$V_B - 25$	$V_B + 0.3$	$V_B - 20$	$V_B + 0.3$	
V_{CC}	Low side fixed supply voltage	-0.3	25	-0.3	20 (Note1)	

Note1: In the IRS2011, all supplies are fully tested at 25 V and an internal 20 V clamp exists for each supply. The 20 V, internal clamp improves the IC survivability against supply transient spikes but at the same time reduces the absolute maximum rating to 20 V.

Recommended Operating Conditions

The minimum V_S is changed from -4 V (IR2011) to -5 V (IRS2011), which increases the V_S negative voltage capability by 1 V.

Dynamic Electrical Characteristics

Parameter		IR2011		IRS2011		Units
Symbol	Definition	typ	max	typ	max	
t_{on}	Turn-on propagation delay ($V_s = 0$ V)	80	-	60	80	ns
t_{off}	Turn-off propagation delay ($V_s = 200$ V)	75	-	60	80	
t_r	Turn-on rise time	35	50	25	40	
t_f	Turn-off fall time	20	35	15	35	

The IRS2011 has reduced in propagation delays and faster rise/fall times when compared to the IR2011.

Static Electrical Characteristics

Parameter		IR2011			IRS2011			Units
Symbol	Definition	min	typ	max	min	typ	max	
V_{IH}	Logic "1" input voltage ($V_{CC} = 10$ V to 20 V)	2.2	-	-	2.5	-	-	V
V_{IL}	Logic "0" input voltage ($V_{CC} = 10$ V to 20 V)	-	-	0.7	-	-	0.7	V
I_{QBS}	Quiescent V_{BS} supply current ($V_{IN} = 0$ V or 3.3V)	-	90	210	-	120	210	uA
I_{QCC}	Quiescent V_{CC} supply current ($V_{IN} = 0$ V or 3.3V)	-	140	230	-	200	300	
I_{IN+}	Logic "1" input bias current	-	7.0	20	-	3.0	10	
I_{IN-}	Logic "0" input bias current	-	-	1.0	-	-	1.0	V
V_{BSUV+}	VBS supply undervoltage positive going threshold	8.2	9.0	9.8	8.3	9.0	9.7	
V_{BSUV-}	VBS supply undervoltage negative going threshold	7.4	8.2	9.0	7.5	8.2	8.9	
V_{CCUV+}	VCC supply undervoltage positive going threshold	8.2	9.0	9.8	8.3	9.0	9.7	
V_{CCUV-}	VCC supply undervoltage negative going threshold	7.4	8.2	9.0	7.5	8.2	8.9	

Some Static Electrical Characteristics are different for the IR2011 and the IRS2011 HVICs. With the IRS2011,

1. V_{IH} is increased to 2.5 V for better noise immunity yet still maintains 3.3 V logic compatibility.
2. Both I_{QCC} and I_{QBS} have increase slightly.
3. The I_{IN+} has been reduced for the IRS2011.
4. The V_{CC} and V_{BS} under voltage thresholds (max and min) show a slight difference between the two devices. This is not expected to have an impact on many designs.

Figures

This figures shown in this section compare figures shown in the IR2011 (left column) and IRS2011 (right column) datasheets. Illustrations that have not changed between the two datasheets have not been included in this section.

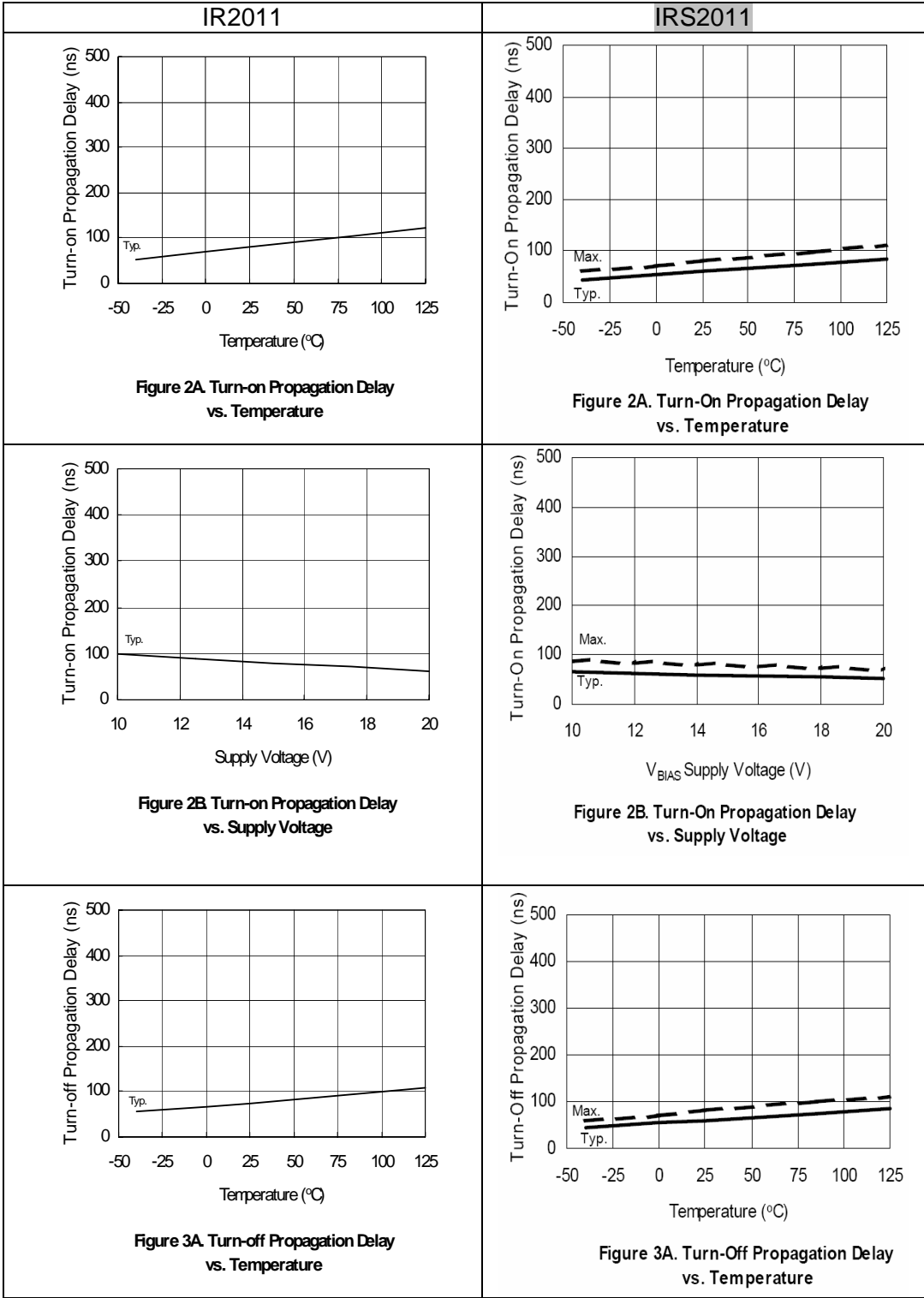

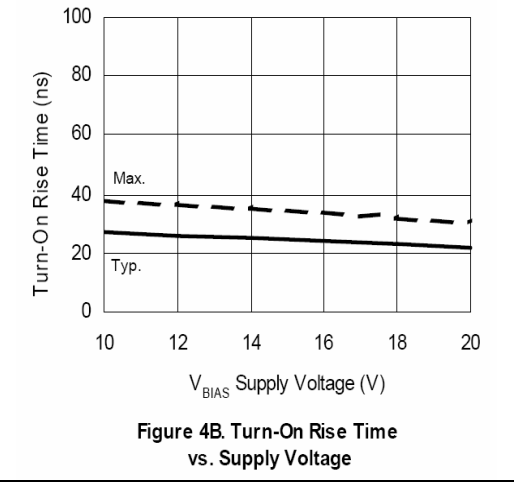
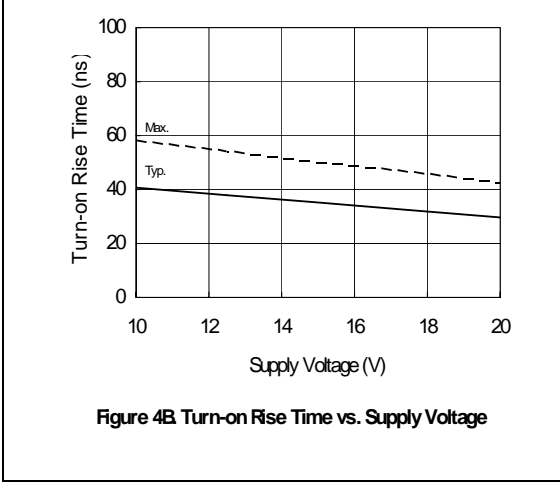
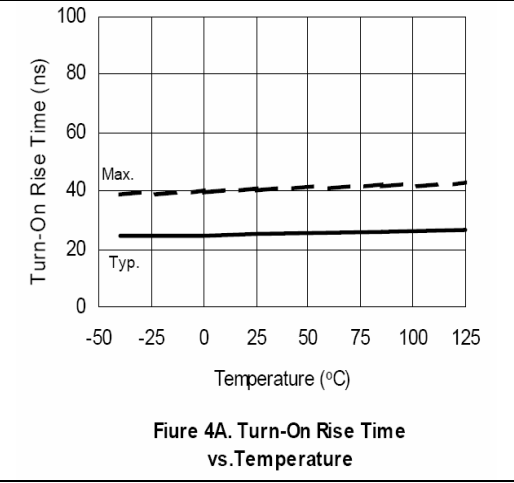
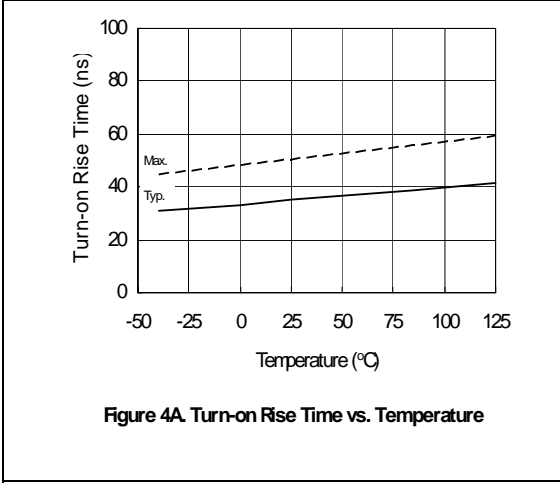
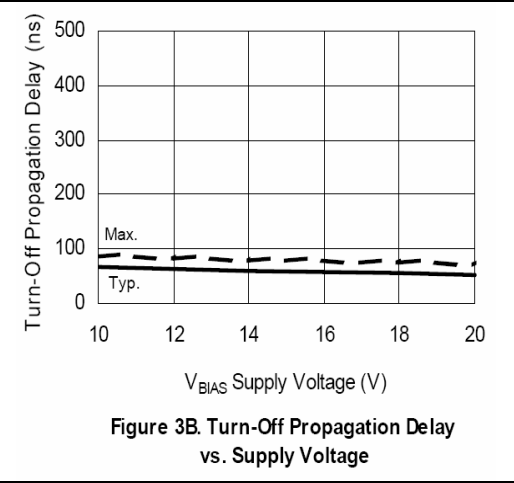
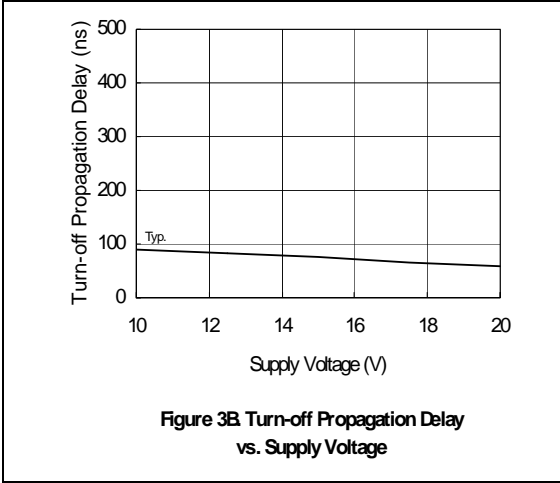

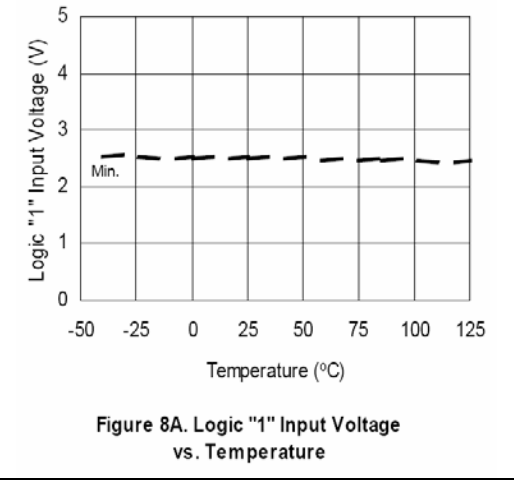
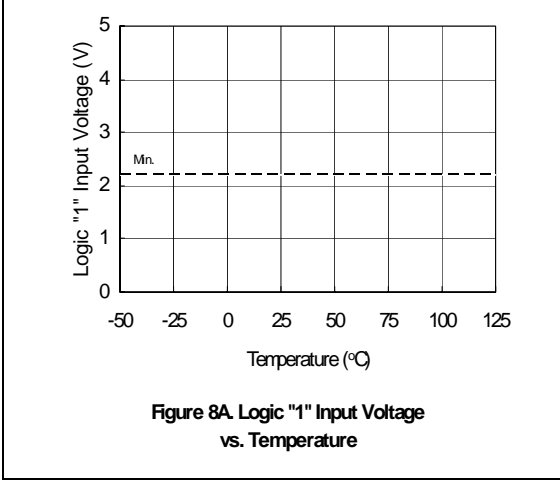
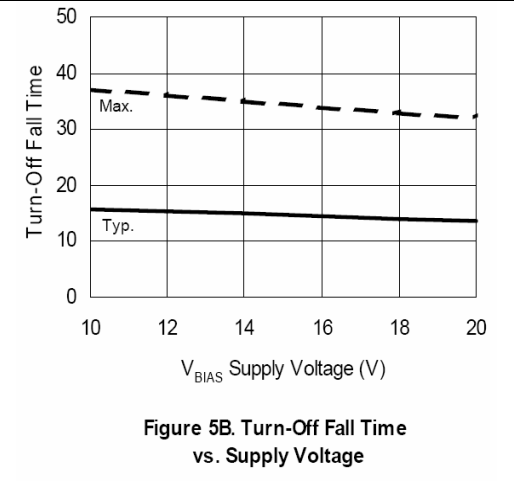
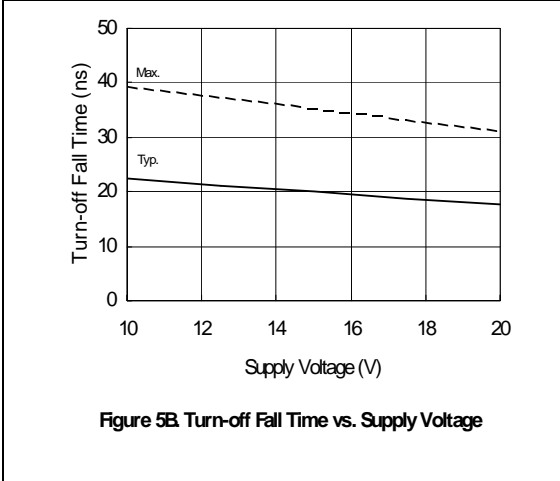
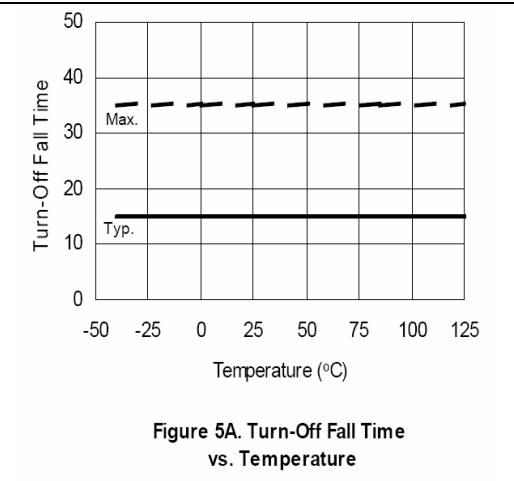
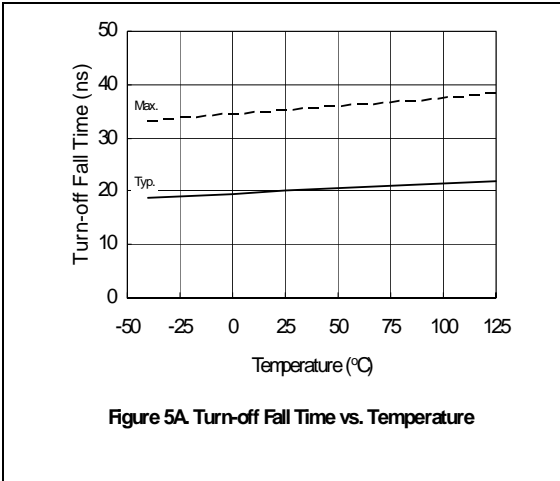

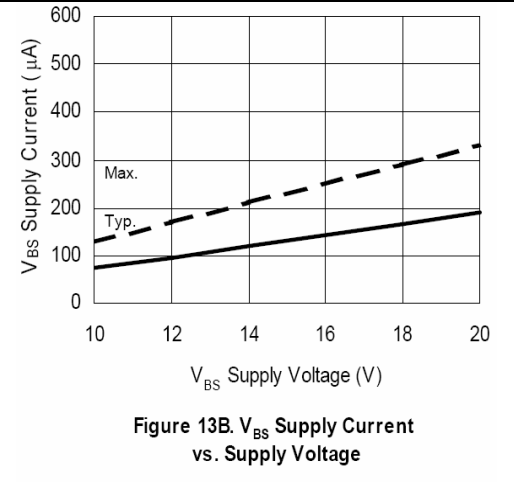
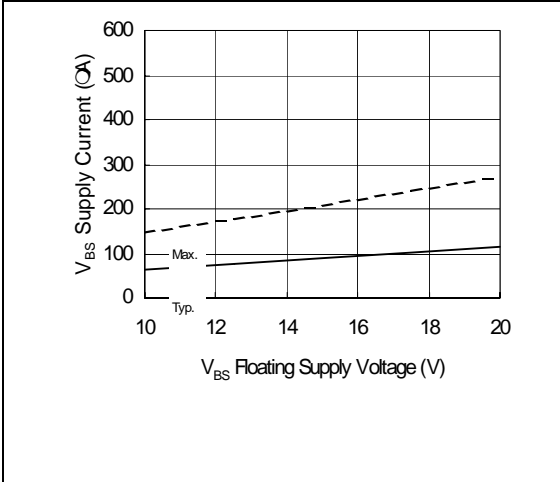
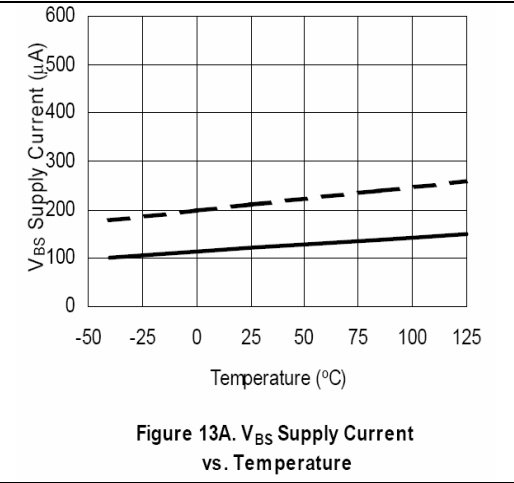
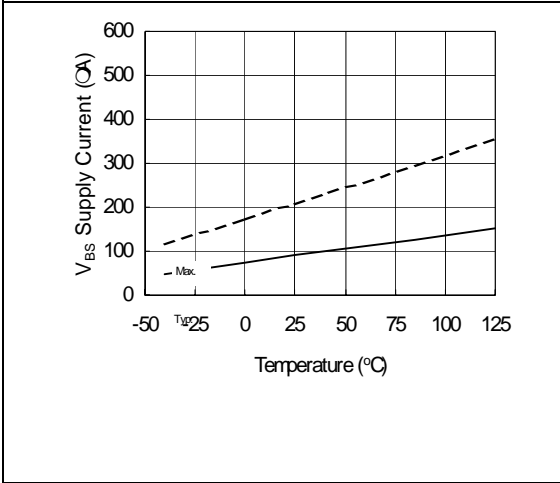
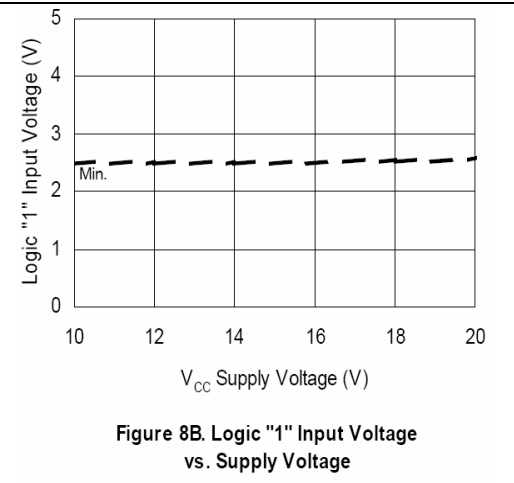
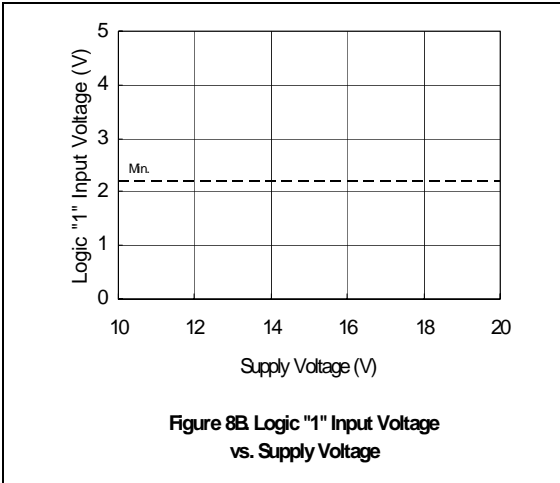

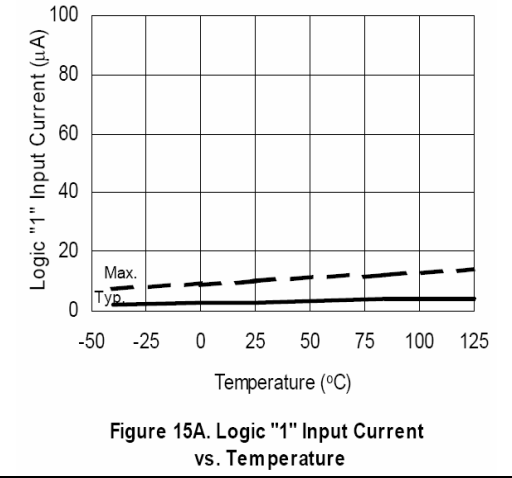
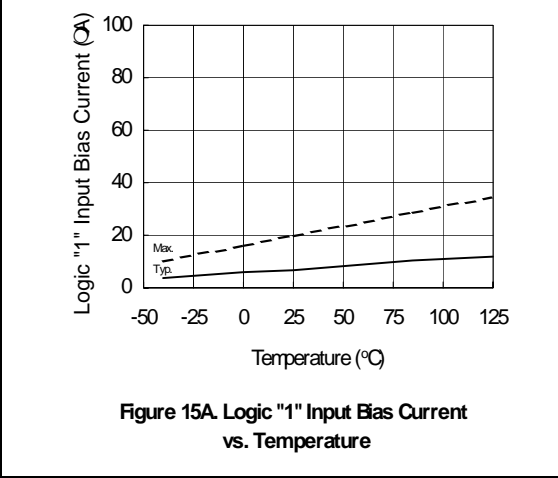
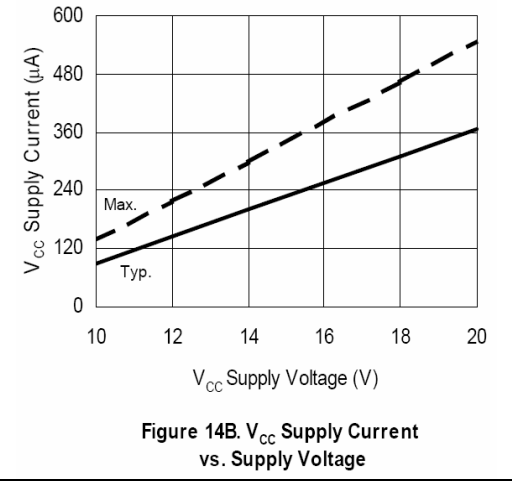
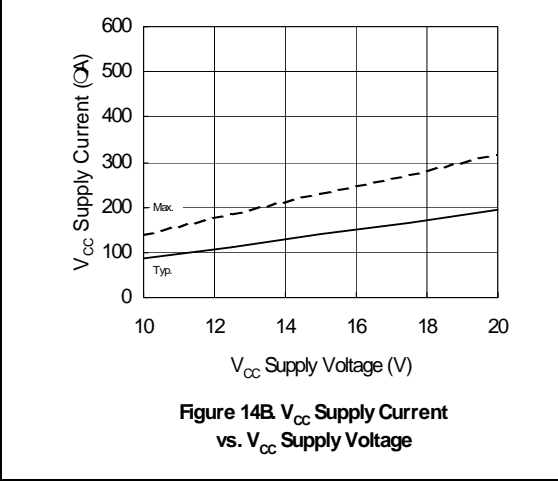
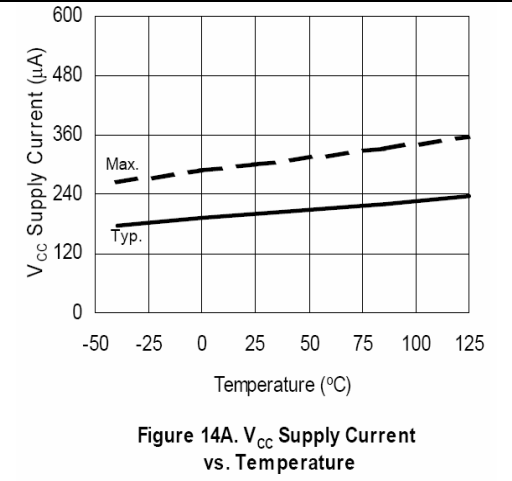
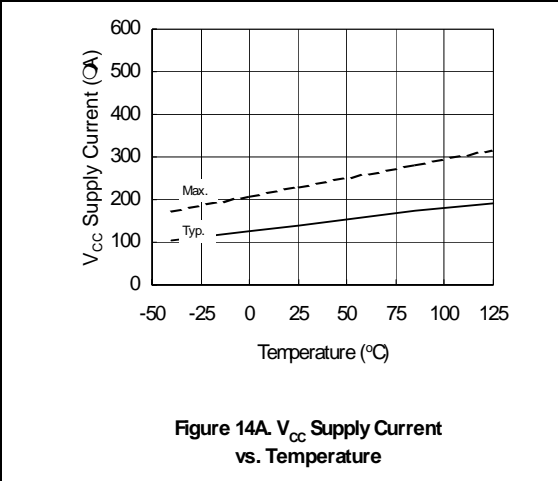

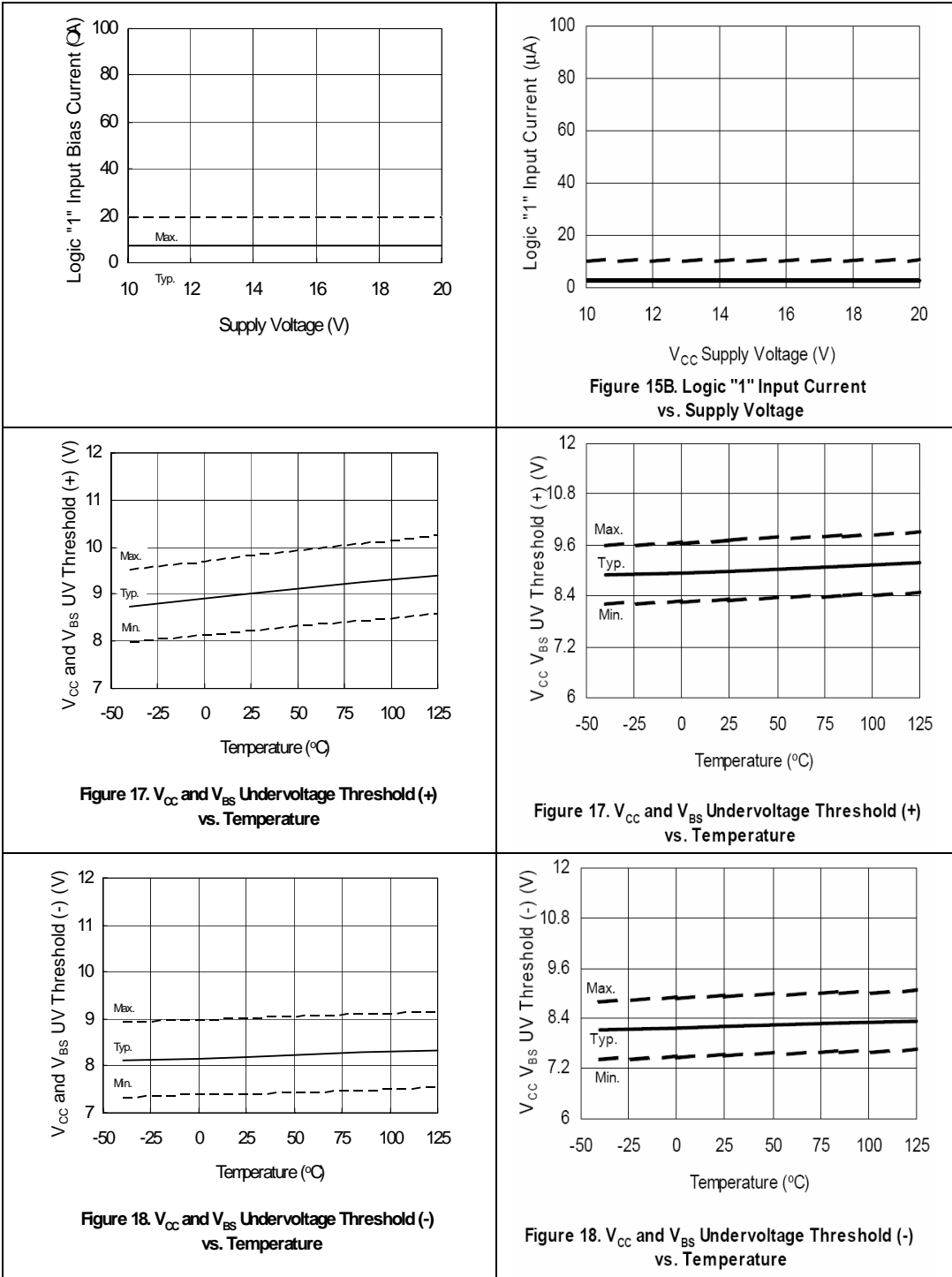

Summary

This document highlights the differences between the IRS2011 and the IR2011 HVICs.