

YOUNG CHANG AKKI CO., LTD.
 Young Chang R&D Inst. - Waltham, MA, USA
 Duplication without the express written consent of
 Young Chang Akki Co., Ltd. is prohibited.
 PC-88 Engine PCB1
 Scanner and Front Panel w/Processor
 Eng: Bob Budd By: _____
 Mfg: SM 1 of 6
 Decs: 021050 4/10/84 Rev: 1V3

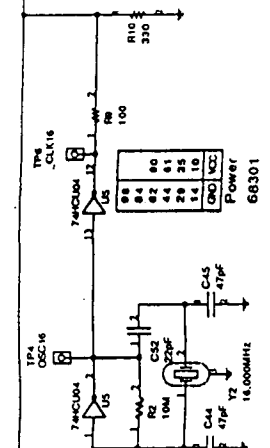

Connector to be placed a minimum of 1.5" from any board edge.

TEST SOCKET

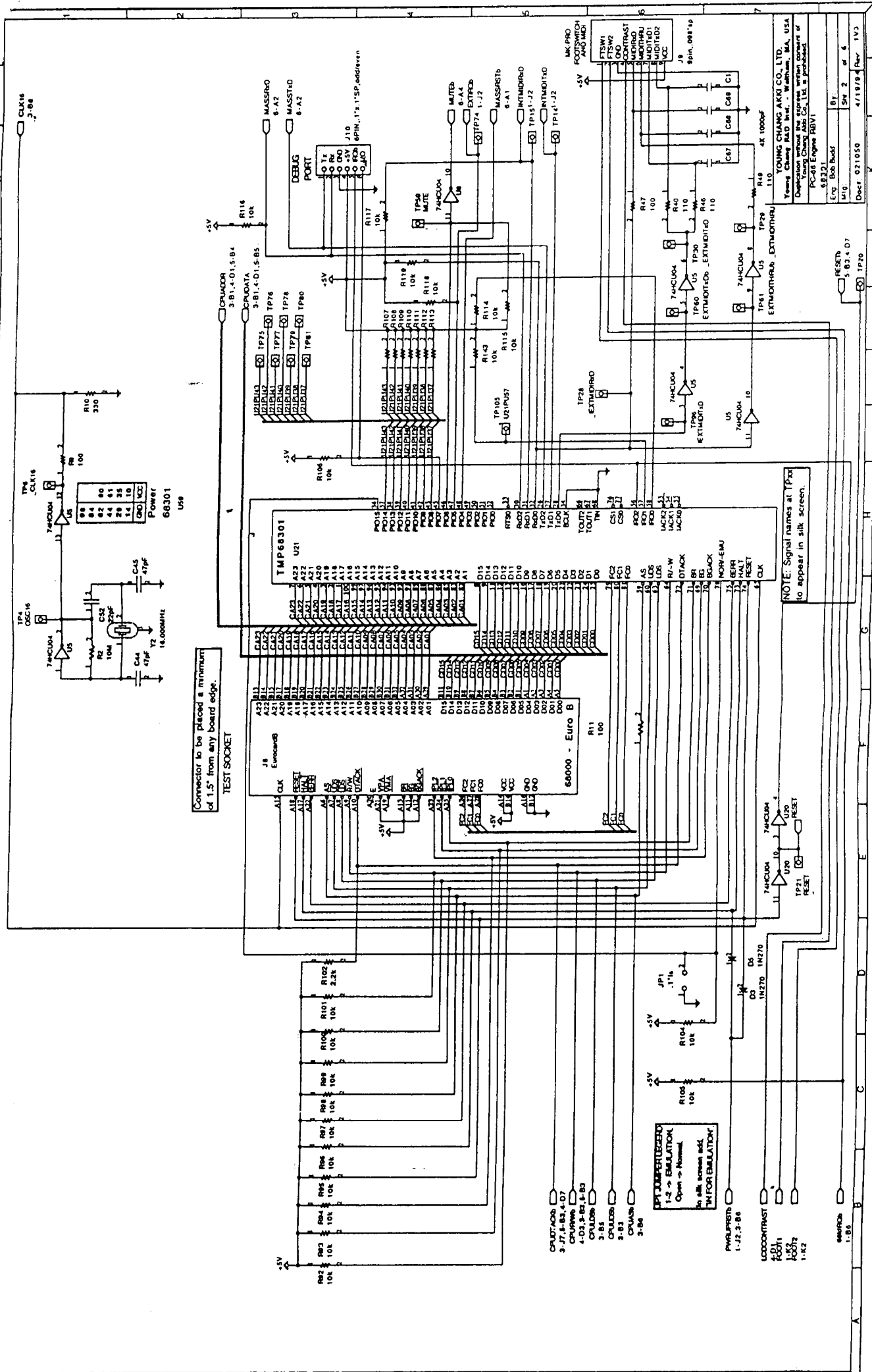
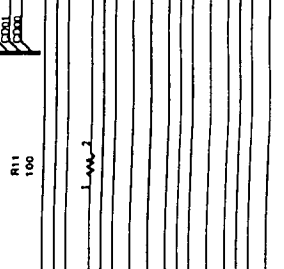
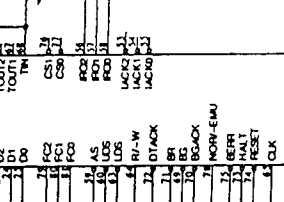
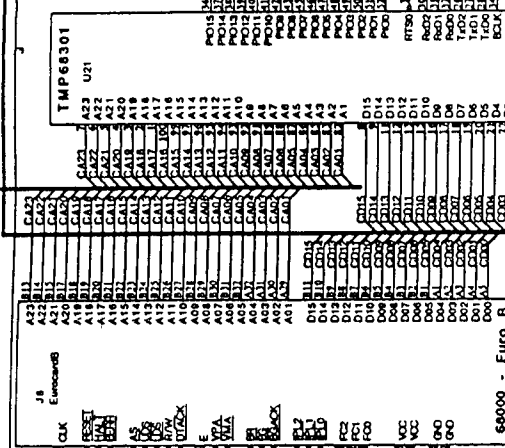

NOTE: Signal names at J10 to appear in silk screen.

YOUNG CHANG AKKI CO. LTD.
 Young Chang Akki Co. Ltd. is a member of
 Department of
 PC-48 Engine RBV1
 58221
 Eng. Bob Budd
 M/G
 Decr. 02.10.50
 4/18/84 Rev 1W3
 Br
 Shr 2 of 6
 1W3

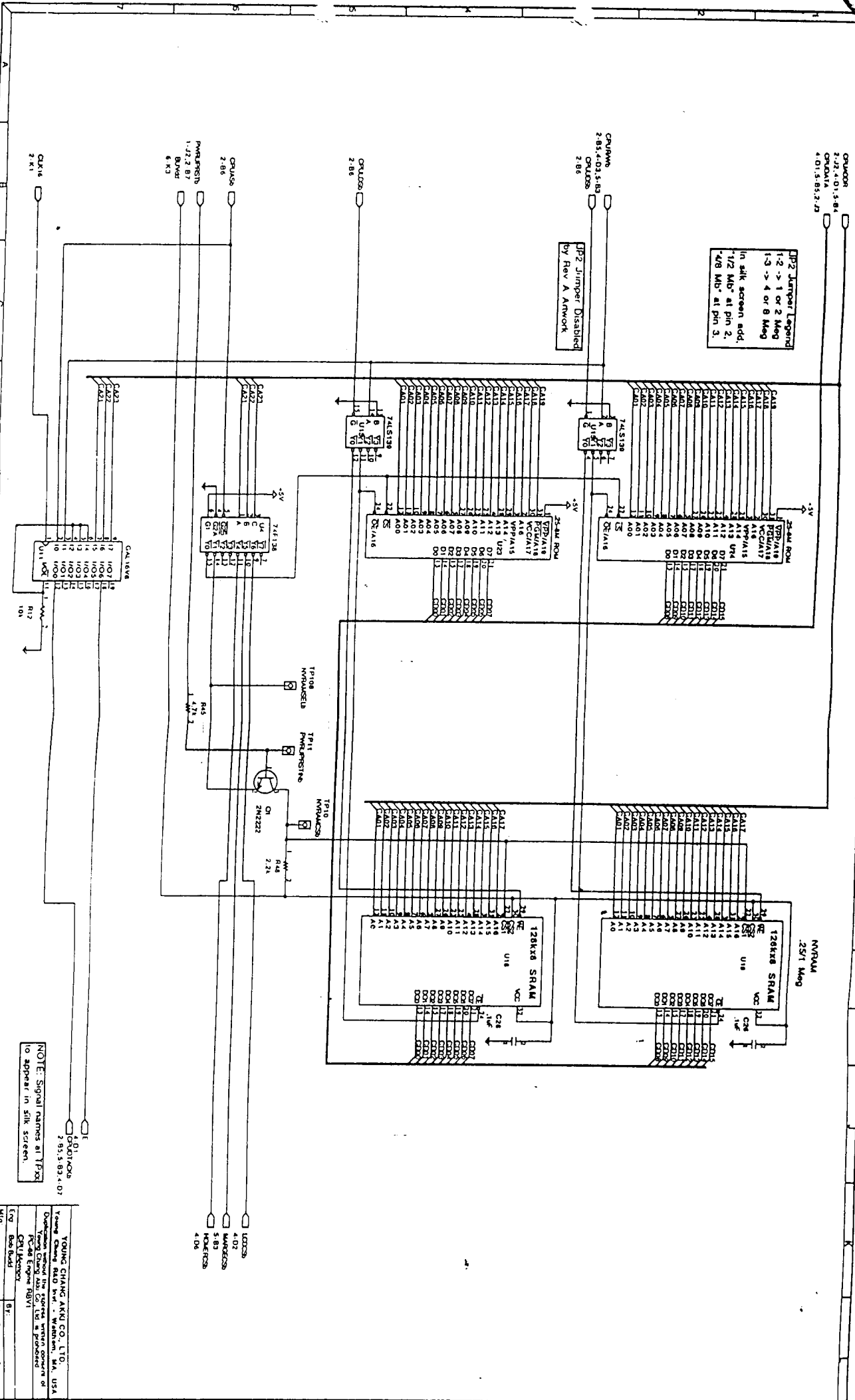

JP2 Jumper Legend
 1-2 -> 1 or 2 Meg
 1-3 -> 4 or 8 Meg
 In silk screen add
 1/2 Mb* at pin 2,
 4/8 Mb* at pin 3.

JP2 Jumper Disabled
 by Rev A Anwork

NOTE: Signal names at JP2X
 to appear in silk screen.

YOUNG CHANG AXELCO, LTD.
 Young Chang Bldg 840 West - Waltham, MA, USA
 Distribution without the express written consent of
 Young Chang Axco, Inc. Ltd. is prohibited.
 CPU00A
 CPU00B
 CPU00C
 CPU00D
 CPU00E
 CPU00F
 CPU00G
 CPU00H
 CPU00I
 CPU00J
 CPU00K
 CPU00L
 CPU00M
 CPU00N
 CPU00O
 CPU00P
 CPU00Q
 CPU00R
 CPU00S
 CPU00T
 CPU00U
 CPU00V
 CPU00W
 CPU00X
 CPU00Y
 CPU00Z
 CPU00AA
 CPU00AB
 CPU00AC
 CPU00AD
 CPU00AE
 CPU00AF
 CPU00AG
 CPU00AH
 CPU00AI
 CPU00AJ
 CPU00AK
 CPU00AL
 CPU00AM
 CPU00AN
 CPU00AO
 CPU00AP
 CPU00AQ
 CPU00AR
 CPU00AS
 CPU00AT
 CPU00AU
 CPU00AV
 CPU00AW
 CPU00AX
 CPU00AY
 CPU00AZ
 CPU00BA
 CPU00BB
 CPU00BC
 CPU00BD
 CPU00BE
 CPU00BF
 CPU00BG
 CPU00BH
 CPU00BI
 CPU00BJ
 CPU00BK
 CPU00BL
 CPU00BM
 CPU00BN
 CPU00BO
 CPU00BP
 CPU00BQ
 CPU00BR
 CPU00BS
 CPU00BT
 CPU00BU
 CPU00BV
 CPU00BW
 CPU00BX
 CPU00BY
 CPU00BZ
 CPU00CA
 CPU00CB
 CPU00CC
 CPU00CD
 CPU00CE
 CPU00CF
 CPU00CG
 CPU00CH
 CPU00CI
 CPU00CJ
 CPU00CK
 CPU00CL
 CPU00CM
 CPU00CN
 CPU00CO
 CPU00CP
 CPU00CQ
 CPU00CR
 CPU00CS
 CPU00CT
 CPU00CU
 CPU00CV
 CPU00CW
 CPU00CX
 CPU00CY
 CPU00CZ
 CPU00DA
 CPU00DB
 CPU00DC
 CPU00DD
 CPU00DE
 CPU00DF
 CPU00DG
 CPU00DH
 CPU00DI
 CPU00DJ
 CPU00DK
 CPU00DL
 CPU00DM
 CPU00DN
 CPU00DO
 CPU00DP
 CPU00DQ
 CPU00DR
 CPU00DS
 CPU00DT
 CPU00DU
 CPU00DV
 CPU00DW
 CPU00DX
 CPU00DY
 CPU00DZ
 CPU00EA
 CPU00EB
 CPU00EC
 CPU00ED
 CPU00EE
 CPU00EF
 CPU00EG
 CPU00EH
 CPU00EI
 CPU00EJ
 CPU00EK
 CPU00EL
 CPU00EM
 CPU00EN
 CPU00EO
 CPU00EP
 CPU00EQ
 CPU00ER
 CPU00ES
 CPU00ET
 CPU00EU
 CPU00EV
 CPU00EW
 CPU00EX
 CPU00EY
 CPU00EZ
 CPU00FA
 CPU00FB
 CPU00FC
 CPU00FD
 CPU00FE
 CPU00FF
 CPU00FG
 CPU00FH
 CPU00FI
 CPU00FJ
 CPU00FK
 CPU00FL
 CPU00FM
 CPU00FN
 CPU00FO
 CPU00FP
 CPU00FQ
 CPU00FR
 CPU00FS
 CPU00FT
 CPU00FU
 CPU00FV
 CPU00FW
 CPU00FX
 CPU00FY
 CPU00FZ
 CPU00GA
 CPU00GB
 CPU00GC
 CPU00GD
 CPU00GE
 CPU00GF
 CPU00GG
 CPU00GH
 CPU00GI
 CPU00GJ
 CPU00GK
 CPU00GL
 CPU00GM
 CPU00GN
 CPU00GO
 CPU00GP
 CPU00GQ
 CPU00GR
 CPU00GS
 CPU00GT
 CPU00GU
 CPU00GV
 CPU00GW
 CPU00GX
 CPU00GY
 CPU00GZ
 CPU00HA
 CPU00HB
 CPU00HC
 CPU00HD
 CPU00HE
 CPU00HF
 CPU00HG
 CPU00HH
 CPU00HI
 CPU00HJ
 CPU00HK
 CPU00HL
 CPU00HM
 CPU00HN
 CPU00HO
 CPU00HP
 CPU00HQ
 CPU00HR
 CPU00HS
 CPU00HT
 CPU00HU
 CPU00HV
 CPU00HW
 CPU00HX
 CPU00HY
 CPU00HZ
 CPU00IA
 CPU00IB
 CPU00IC
 CPU00ID
 CPU00IE
 CPU00IF
 CPU00IG
 CPU00IH
 CPU00II
 CPU00IJ
 CPU00IK
 CPU00IL
 CPU00IM
 CPU00IN
 CPU00IO
 CPU00IP
 CPU00IQ
 CPU00IR
 CPU00IS
 CPU00IT
 CPU00IU
 CPU00IV
 CPU00IW
 CPU00IX
 CPU00IY
 CPU00IZ
 CPU00JA
 CPU00JB
 CPU00JC
 CPU00JD
 CPU00JE
 CPU00JF
 CPU00JG
 CPU00JH
 CPU00JI
 CPU00JJ
 CPU00JK
 CPU00JL
 CPU00JM
 CPU00JN
 CPU00JO
 CPU00JP
 CPU00JQ
 CPU00JR
 CPU00JS
 CPU00JT
 CPU00JU
 CPU00JV
 CPU00JW
 CPU00JX
 CPU00JY
 CPU00JZ
 CPU00KA
 CPU00KB
 CPU00KC
 CPU00KD
 CPU00KE
 CPU00KF
 CPU00KG
 CPU00KH
 CPU00KI
 CPU00KJ
 CPU00KK
 CPU00KL
 CPU00KM
 CPU00KN
 CPU00KO
 CPU00KP
 CPU00KQ
 CPU00KR
 CPU00KS
 CPU00KT
 CPU00KU
 CPU00KV
 CPU00KW
 CPU00KX
 CPU00KY
 CPU00KZ
 CPU00LA
 CPU00LB
 CPU00LC
 CPU00LD
 CPU00LE
 CPU00LF
 CPU00LG
 CPU00LH
 CPU00LI
 CPU00LJ
 CPU00LK
 CPU00LM
 CPU00LN
 CPU00LO
 CPU00LP
 CPU00LQ
 CPU00LR
 CPU00LS
 CPU00LT
 CPU00LU
 CPU00LV
 CPU00LW
 CPU00LX
 CPU00LY
 CPU00LZ
 CPU00MA
 CPU00MB
 CPU00MC
 CPU00MD
 CPU00ME
 CPU00MF
 CPU00MG
 CPU00MH
 CPU00MI
 CPU00MJ
 CPU00MK
 CPU00ML
 CPU00MM
 CPU00MN
 CPU00MO
 CPU00MP
 CPU00MQ
 CPU00MR
 CPU00MS
 CPU00MT
 CPU00MU
 CPU00MV
 CPU00MW
 CPU00MX
 CPU00MY
 CPU00MZ
 CPU00NA
 CPU00NB
 CPU00NC
 CPU00ND
 CPU00NE
 CPU00NF
 CPU00NG
 CPU00NH
 CPU00NI
 CPU00NJ
 CPU00NK
 CPU00NL
 CPU00NM
 CPU00NN
 CPU00NO
 CPU00NP
 CPU00NQ
 CPU00NR
 CPU00NS
 CPU00NT
 CPU00NU
 CPU00NV
 CPU00NW
 CPU00NX
 CPU00NY
 CPU00NZ
 CPU00OA
 CPU00OB
 CPU00OC
 CPU00OD
 CPU00OE
 CPU00OF
 CPU00OG
 CPU00OH
 CPU00OI
 CPU00OJ
 CPU00OK
 CPU00OL
 CPU00OM
 CPU00ON
 CPU00OO
 CPU00OP
 CPU00OQ
 CPU00OR
 CPU00OS
 CPU00OT
 CPU00OU
 CPU00OV
 CPU00OW
 CPU00OX
 CPU00OY
 CPU00OZ
 CPU00PA
 CPU00PB
 CPU00PC
 CPU00PD
 CPU00PE
 CPU00PF
 CPU00PG
 CPU00PH
 CPU00PI
 CPU00PJ
 CPU00PK
 CPU00PL
 CPU00PM
 CPU00PN
 CPU00PO
 CPU00PP
 CPU00PQ
 CPU00PR
 CPU00PS
 CPU00PT
 CPU00PU
 CPU00PV
 CPU00PW
 CPU00PX
 CPU00PY
 CPU00PZ
 CPU00QA
 CPU00QB
 CPU00QC
 CPU00QD
 CPU00QE
 CPU00QF
 CPU00QG
 CPU00QH
 CPU00QI
 CPU00QJ
 CPU00QK
 CPU00QL
 CPU00QM
 CPU00QN
 CPU00QO
 CPU00QP
 CPU00QQ
 CPU00QR
 CPU00QS
 CPU00QT
 CPU00QU
 CPU00QV
 CPU00QW
 CPU00QX
 CPU00QY
 CPU00QZ
 CPU00RA
 CPU00RB
 CPU00RC
 CPU00RD
 CPU00RE
 CPU00RF
 CPU00RG
 CPU00RH
 CPU00RI
 CPU00RJ
 CPU00RK
 CPU00RL
 CPU00RM
 CPU00RN
 CPU00RO
 CPU00RP
 CPU00RQ
 CPU00RR
 CPU00RS
 CPU00RT
 CPU00RU
 CPU00RV
 CPU00RW
 CPU00RX
 CPU00RY
 CPU00RZ
 CPU00SA
 CPU00SB
 CPU00SC
 CPU00SD
 CPU00SE
 CPU00SF
 CPU00SG
 CPU00SH
 CPU00SI
 CPU00SJ
 CPU00SK
 CPU00SL
 CPU00SM
 CPU00SN
 CPU00SO
 CPU00SP
 CPU00SQ
 CPU00SR
 CPU00SS
 CPU00ST
 CPU00SU
 CPU00SV
 CPU00SW
 CPU00SX
 CPU00SY
 CPU00SZ
 CPU00TA
 CPU00TB
 CPU00TC
 CPU00TD
 CPU00TE
 CPU00TF
 CPU00TG
 CPU00TH
 CPU00TI
 CPU00TJ
 CPU00TK
 CPU00TL
 CPU00TM
 CPU00TN
 CPU00TO
 CPU00TP
 CPU00TQ
 CPU00TR
 CPU00TS
 CPU00TT
 CPU00TU
 CPU00TV
 CPU00TW
 CPU00TX
 CPU00TY
 CPU00TZ
 CPU00UA
 CPU00UB
 CPU00UC
 CPU00UD
 CPU00UE
 CPU00UF
 CPU00UG
 CPU00UH
 CPU00UI
 CPU00UJ
 CPU00UK
 CPU00UL
 CPU00UM
 CPU00UN
 CPU00UO
 CPU00UP
 CPU00UQ
 CPU00UR
 CPU00US
 CPU00UT
 CPU00UU
 CPU00UV
 CPU00UW
 CPU00UX
 CPU00UY
 CPU00UZ
 CPU00VA
 CPU00VB
 CPU00VC
 CPU00VD
 CPU00VE
 CPU00VF
 CPU00VG
 CPU00VH
 CPU00VI
 CPU00VJ
 CPU00VK
 CPU00VL
 CPU00VM
 CPU00VN
 CPU00VO
 CPU00VP
 CPU00VQ
 CPU00VR
 CPU00VS
 CPU00VT
 CPU00VU
 CPU00VV
 CPU00VW
 CPU00VX
 CPU00VY
 CPU00VZ
 CPU00WA
 CPU00WB
 CPU00WC
 CPU00WD
 CPU00WE
 CPU00WF
 CPU00WG
 CPU00WH
 CPU00WI
 CPU00WJ
 CPU00WK
 CPU00WL
 CPU00WM
 CPU00WN
 CPU00WO
 CPU00WP
 CPU00WQ
 CPU00WR
 CPU00WS
 CPU00WT
 CPU00WU
 CPU00WV
 CPU00WW
 CPU00WX
 CPU00WY
 CPU00WZ
 CPU00XA
 CPU00XB
 CPU00XC
 CPU00XD
 CPU00XE
 CPU00XF
 CPU00XG
 CPU00XH
 CPU00XI
 CPU00XJ
 CPU00XK
 CPU00XL
 CPU00XM
 CPU00XN
 CPU00XO
 CPU00XP
 CPU00XQ
 CPU00XR
 CPU00XS
 CPU00XT
 CPU00XU
 CPU00XV
 CPU00XW
 CPU00XX
 CPU00XY
 CPU00XZ
 CPU00YA
 CPU00YB
 CPU00YC
 CPU00YD
 CPU00YE
 CPU00YF
 CPU00YG
 CPU00YH
 CPU00YI
 CPU00YJ
 CPU00YK
 CPU00YL
 CPU00YM
 CPU00YN
 CPU00YO
 CPU00YP
 CPU00YQ
 CPU00YR
 CPU00YS
 CPU00YT
 CPU00YU
 CPU00YV
 CPU00YW
 CPU00YX
 CPU00YZ
 CPU00ZA
 CPU00ZB
 CPU00ZC
 CPU00ZD
 CPU00ZE
 CPU00ZF
 CPU00ZG
 CPU00ZH
 CPU00ZI
 CPU00ZJ
 CPU00ZK
 CPU00ZL
 CPU00ZM
 CPU00ZN
 CPU00ZO
 CPU00ZP
 CPU00ZQ
 CPU00ZR
 CPU00ZS
 CPU00ZT
 CPU00ZU
 CPU00ZV
 CPU00ZW
 CPU00ZX
 CPU00ZY
 CPU00ZZ

Order 021050 4/19/84 Rev. 1V3

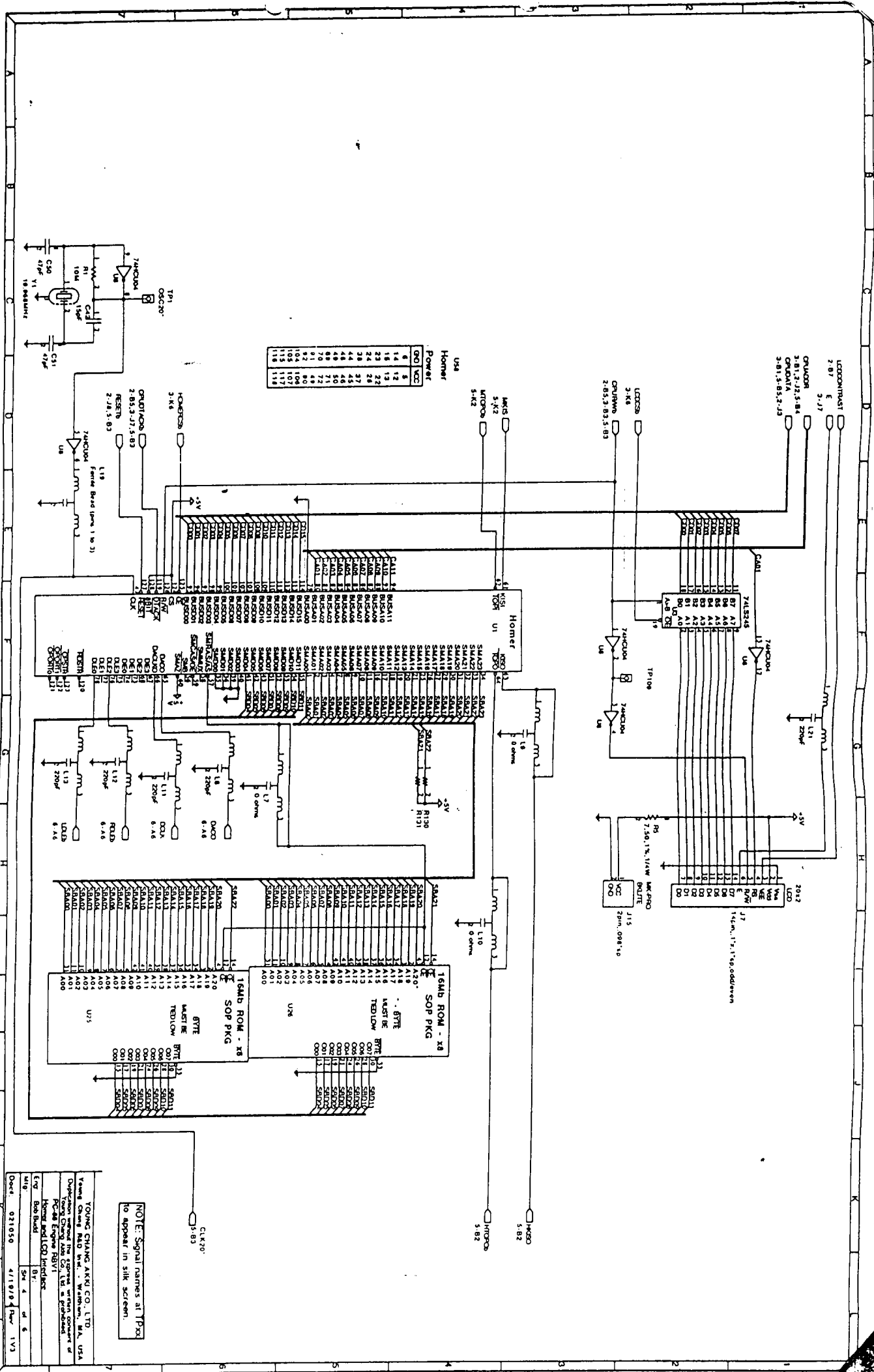

NO	VCC
6	5
14	12
18	13
23	22
24	24
34	32
44	44
48	48
48	48
48	48
48	48
70	72
81	88
82	80
102	102
109	107
115	117
118	118

USA
Homer
Power

NOTE: Signal names at 1Pcs to appear in silk screen.

YOUNG CHANG AKKI CO LTD.
Young Chang Road Int. Washington, Md. USA
Duplication without the express written consent of
Young Chang Akki Co. Ltd. is prohibited.
PCB Design Engineer REAYT
Checked by: [Signature]
Est. No. [Number] Rev. 4 of 6
Date: 02/10/80 File: 143

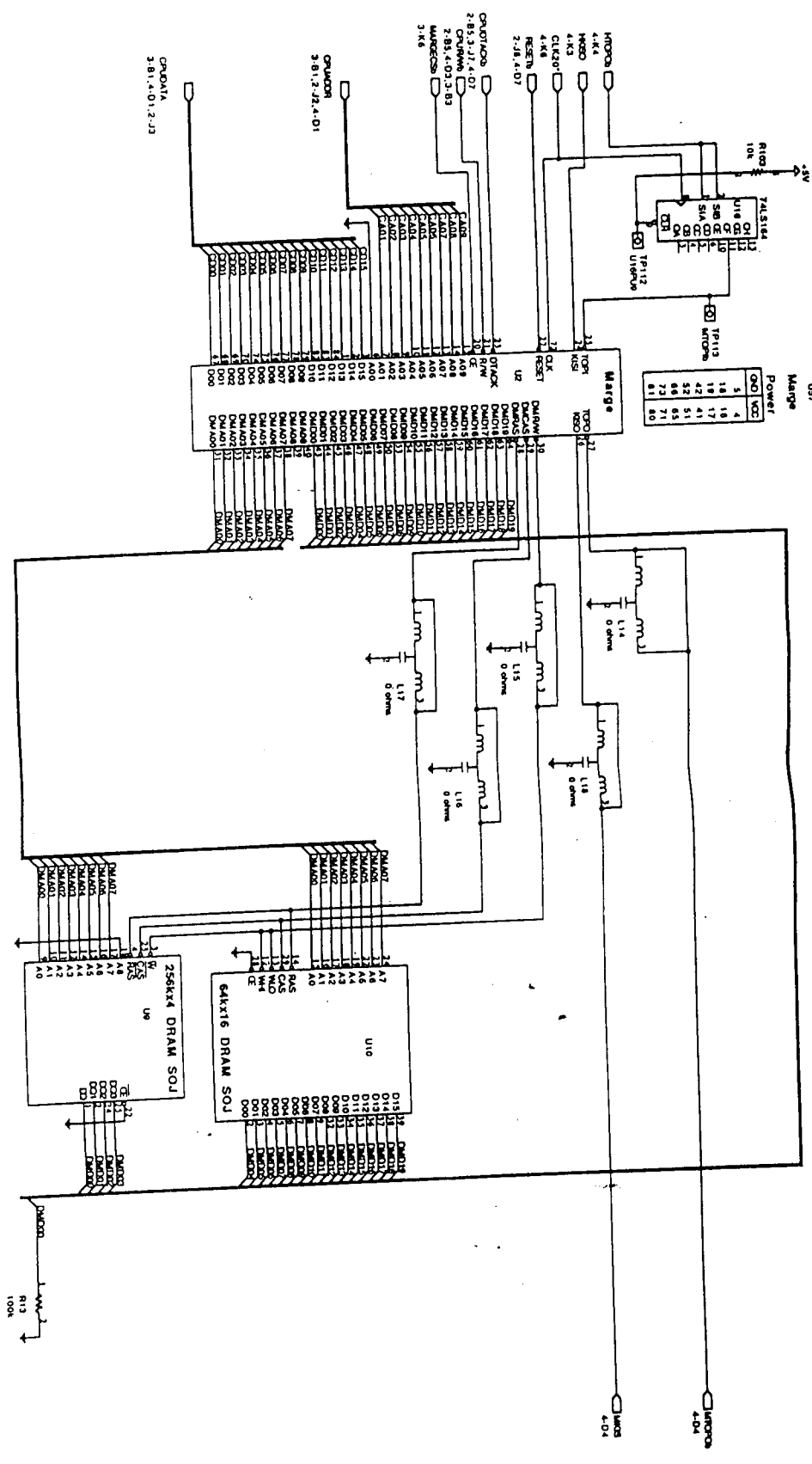

NOTE: Signal names at PPA to appear in silk screen.

YOUNG CHANG AKING CO., LTD
 Young Chang Road, Hsinchu, Hsinchu County, Taiwan, R.O.C.
 Hsinchu, Hsinchu County, Taiwan, R.O.C.
 YOUNG CHANG AKING CO., LTD. USA
 10000 Wilshire Blvd., Suite 1000, Los Angeles, CA 90024
 PC-251 Engine RSV1
 Hsinchu W. District, Taiwan
 BY: SM S M S
 Eng: Bao Budd
 Date: 021050 4/18/8 Rev: 1V3

DECOUPLING CAPS. ONE AT EACH GROUND PIN OF U1, U2, U4, U5, U6, U7, U8, U9, U11, U12, U13, U14, U15, U16, U17, U18, U19, U20, U21, U22, U23, U24, U25, U26, U27, U28, U29, U30, U31, U32, U33, U34, U35, U36, U37, U38, U39, U40, U41, U42, U43, U44, U45, U46, U47, U48, U49, U50.

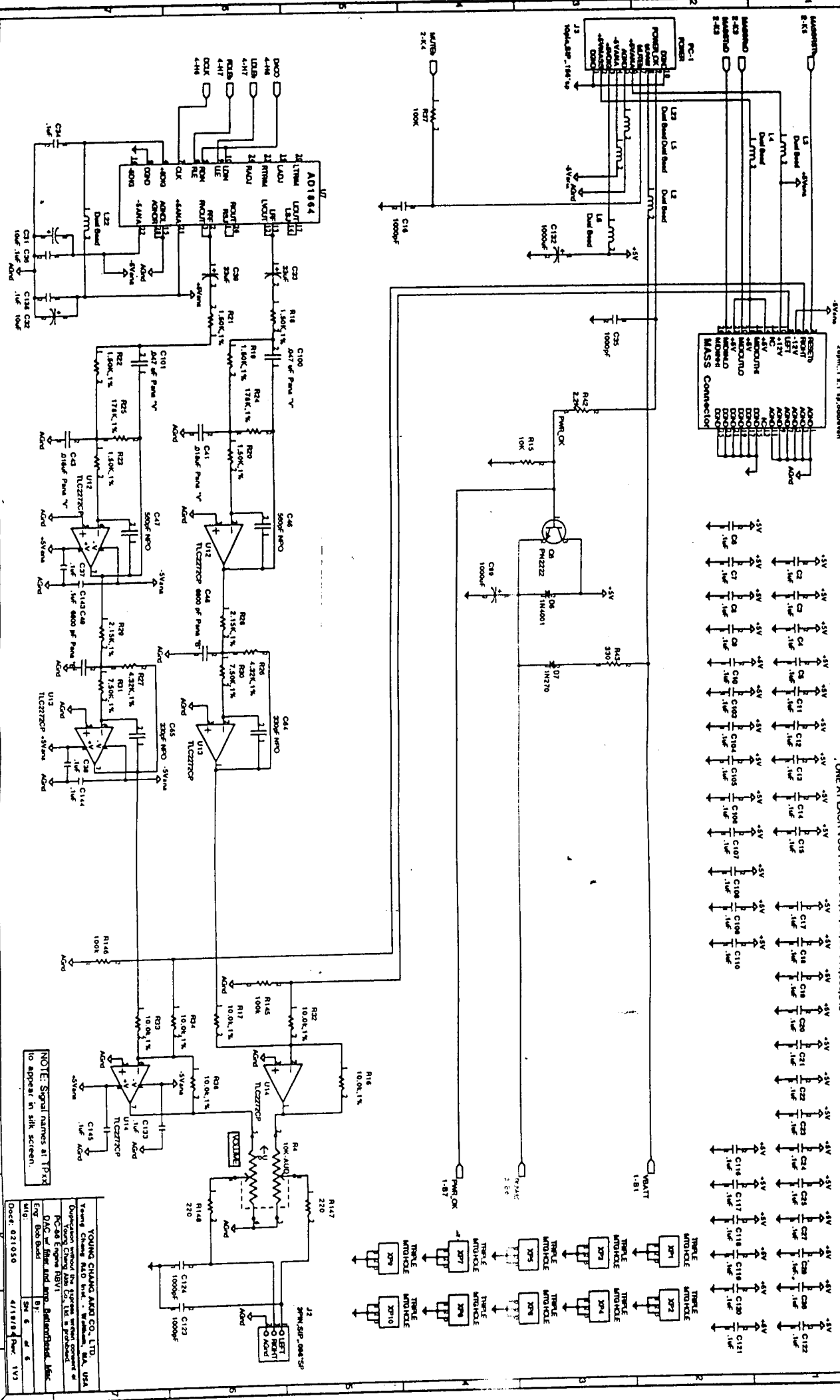

NOTE: Signal names at TP's to appear in silk screen.

YOUNG CHANG AND CO. LTD.
 Young Chang and Co. Ltd. - Waltham, MA, USA
 Distribution without the system written consent of
 Young Chang and Co. Ltd. is prohibited.
 DAC of film and temp. dependent. See
 Eng. Rec. Book
 BY: S. S. at 6
 DATE: 02/10/80
 4/18/80 Rev. 1V3