

Footswitch Wiring Guide

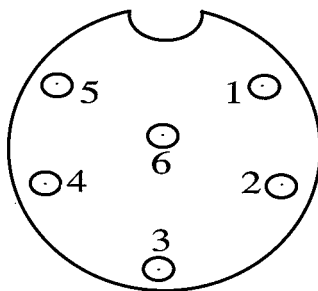

326 Hwy 11/80 East Meridian, MS 39301

CENTURION MK-3

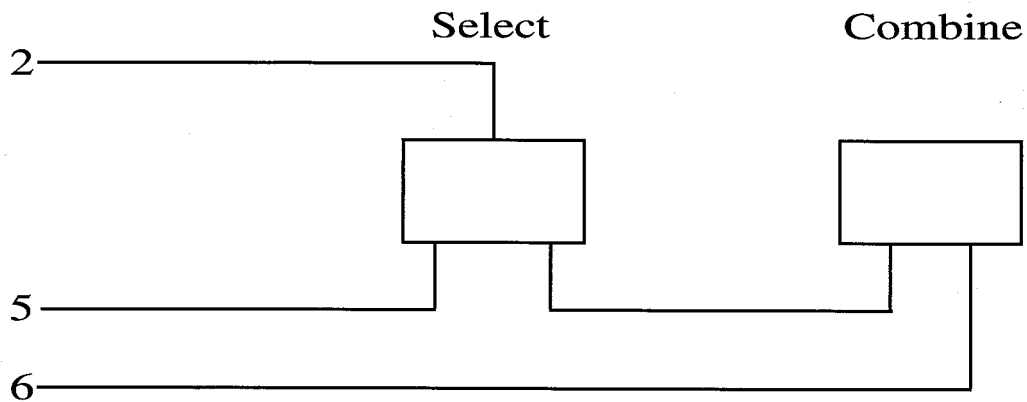

← solder side of 6 pin DIN

5150 FTSW

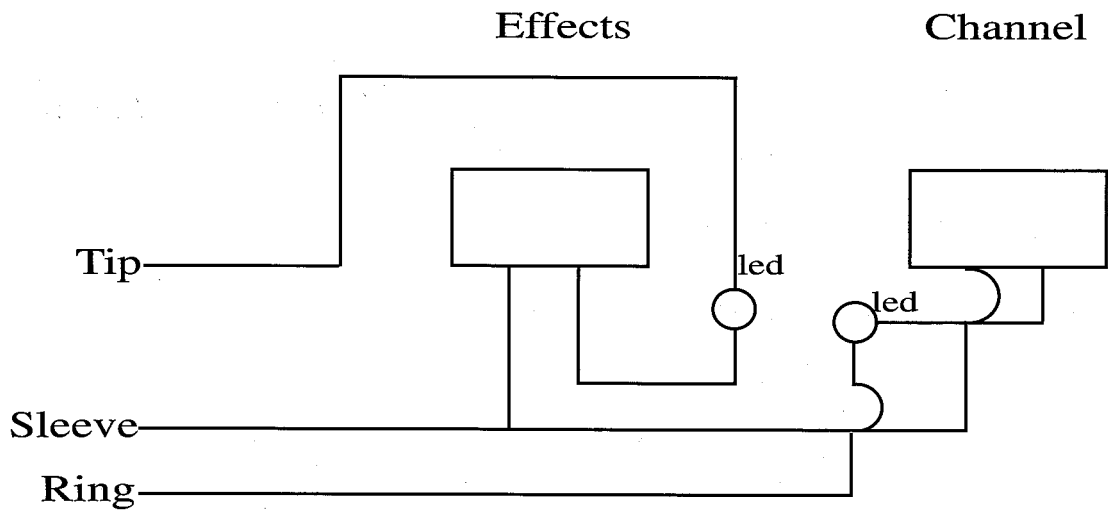

RENOWN-112/212 #57022

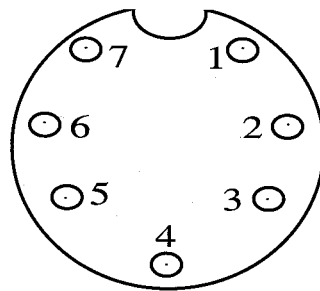
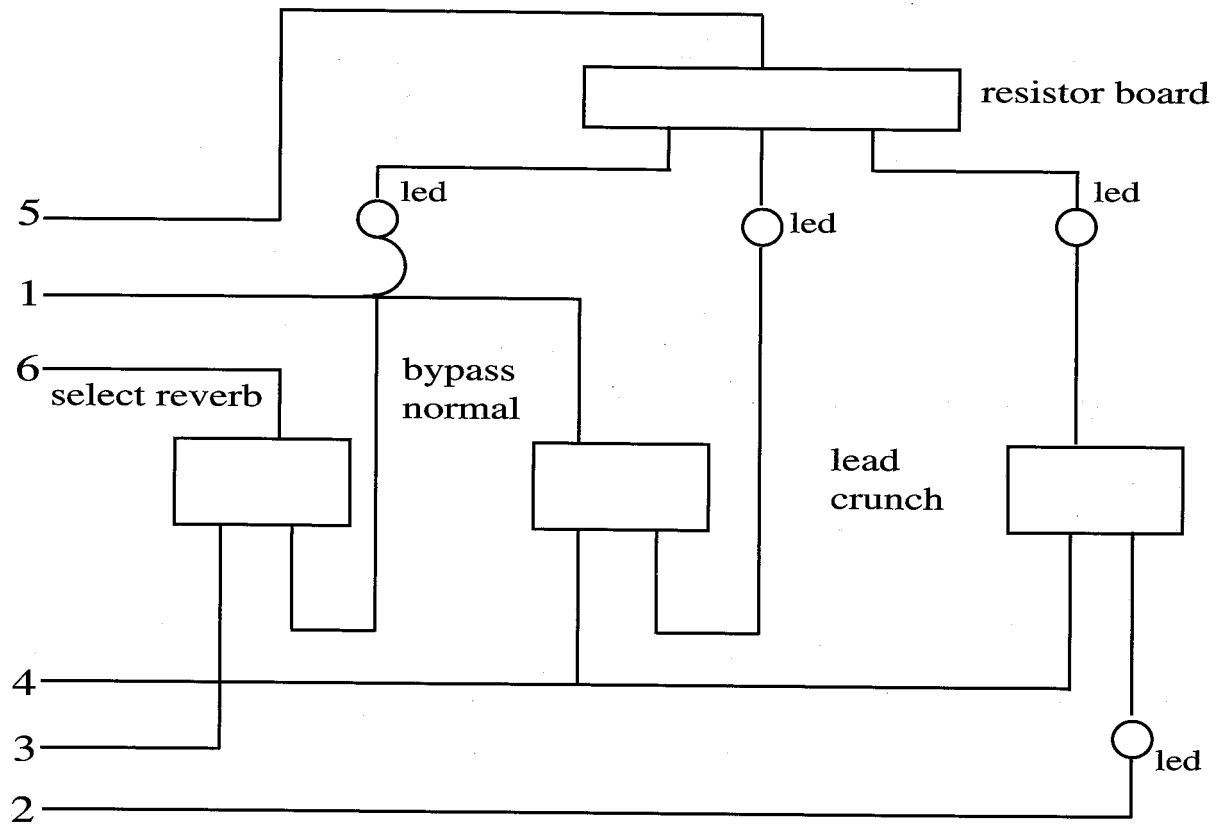

← solder side of 7 pin DIN

TRIUMPH PAG-60/120

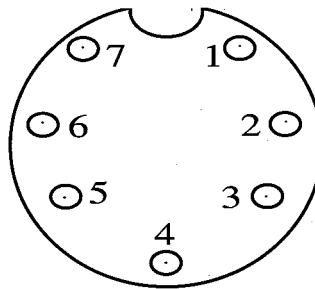
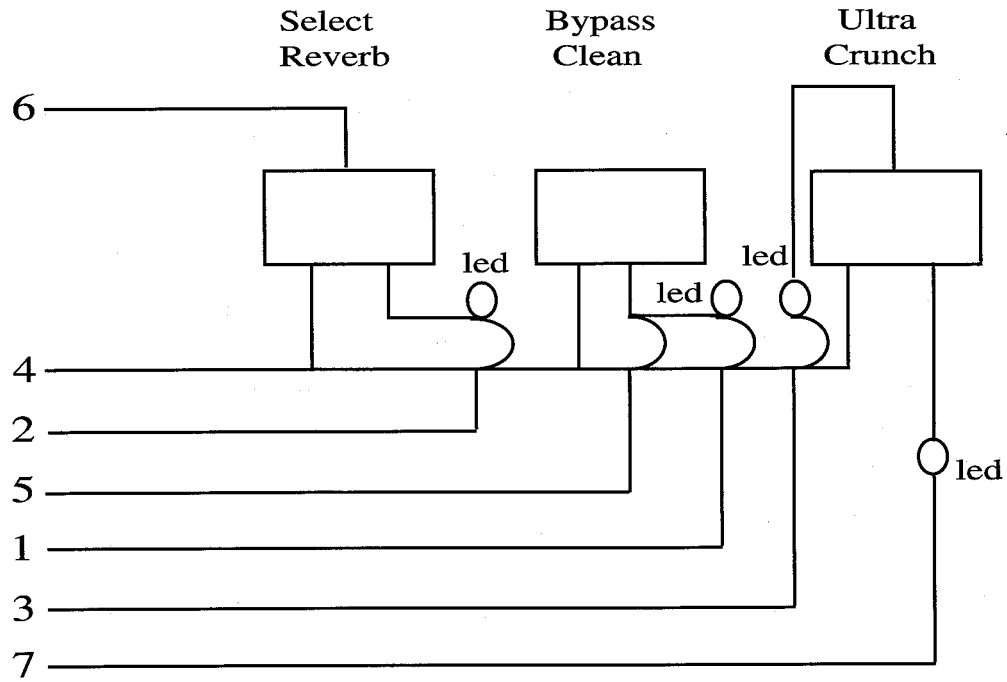

← solder side of 7 pin DIN

Stereo Chorus 400

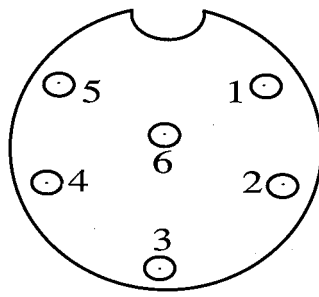
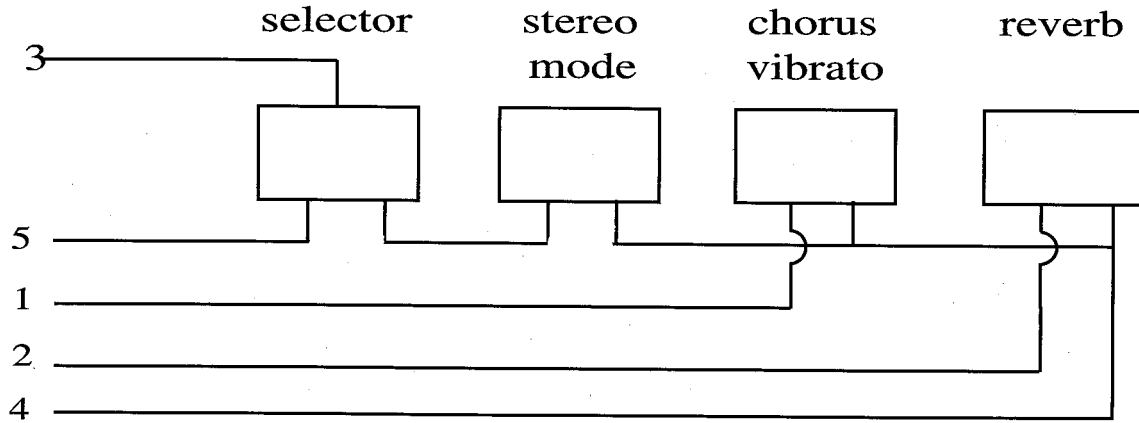

CLASSIC VTX Footswitch

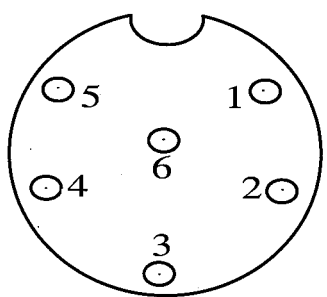
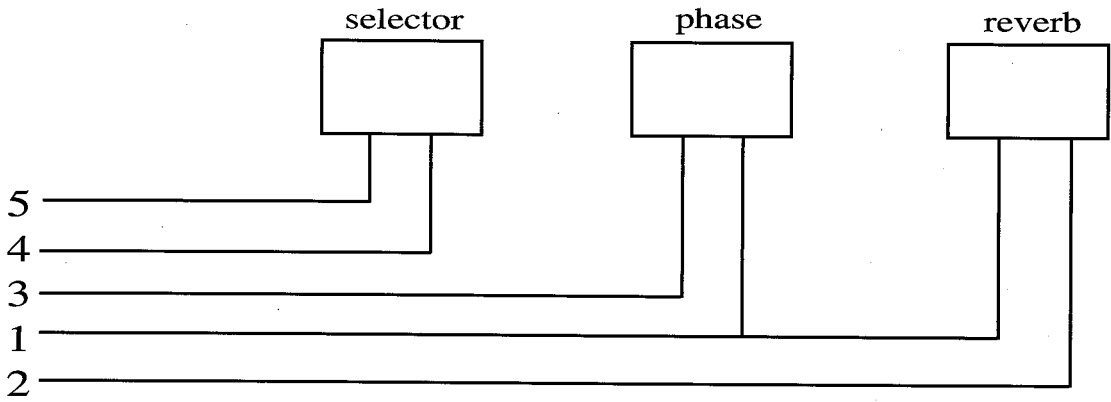

← solder side of 6 pin DIN

Classic Chorus 212, Studio Chorus 210, Backstage 208

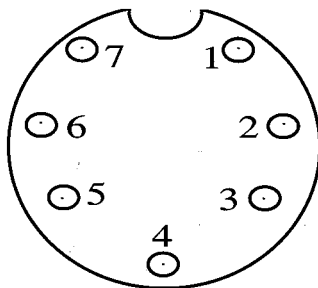
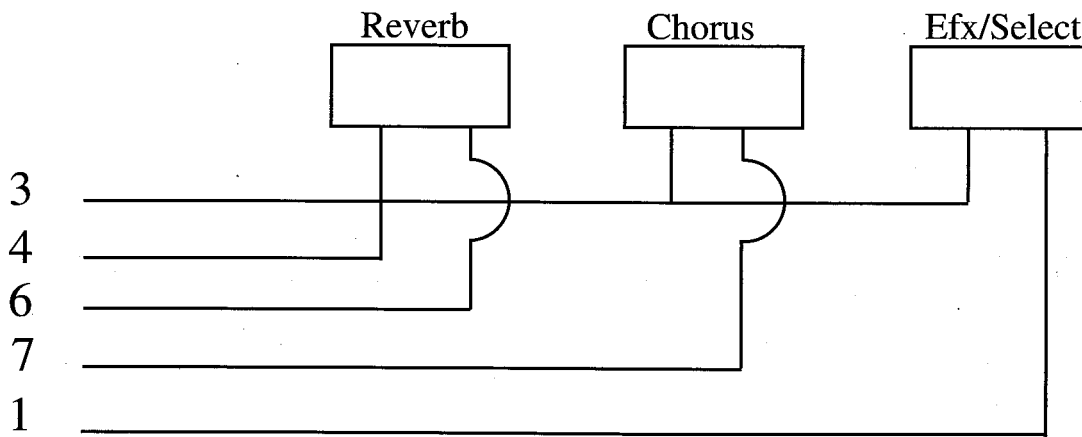

← solder side of 7 pin DIM

Stereo Chorus 212

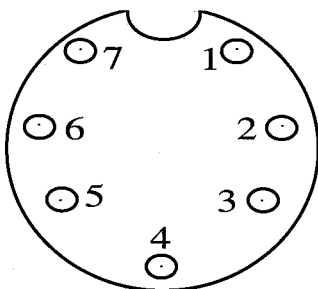
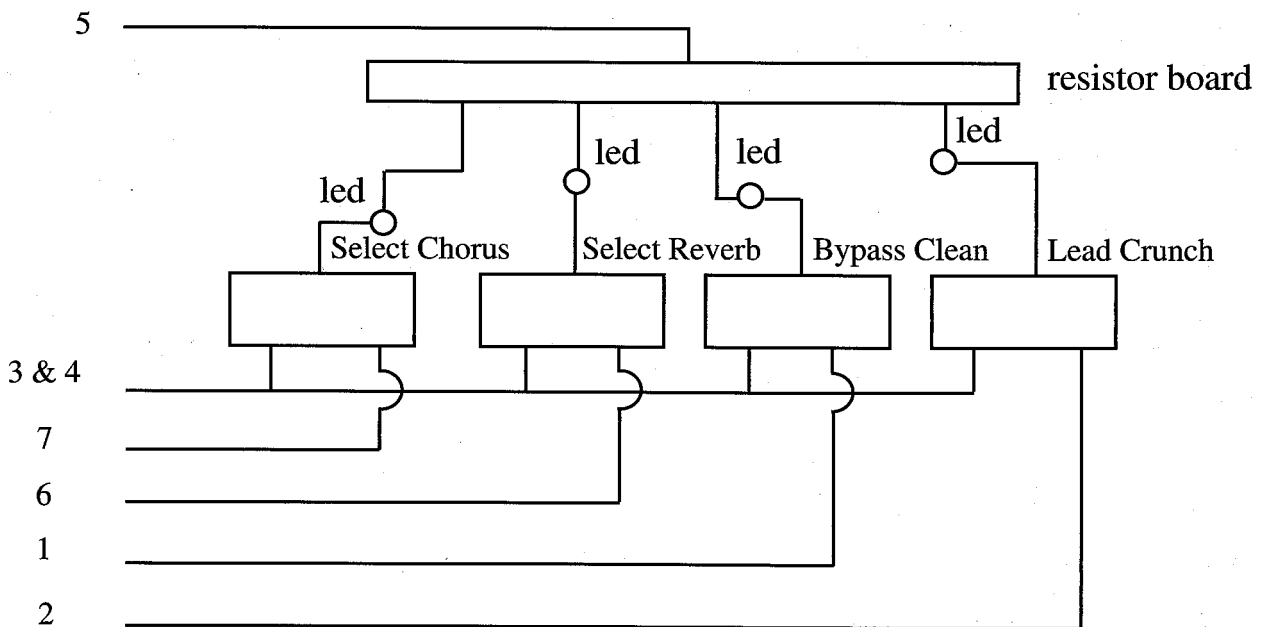

← solder side of 7 pin DIM

HERITAGE Footswitch

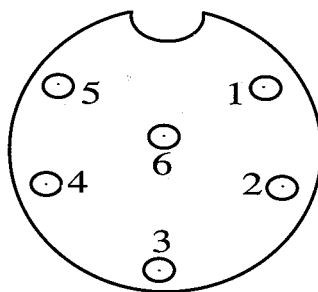
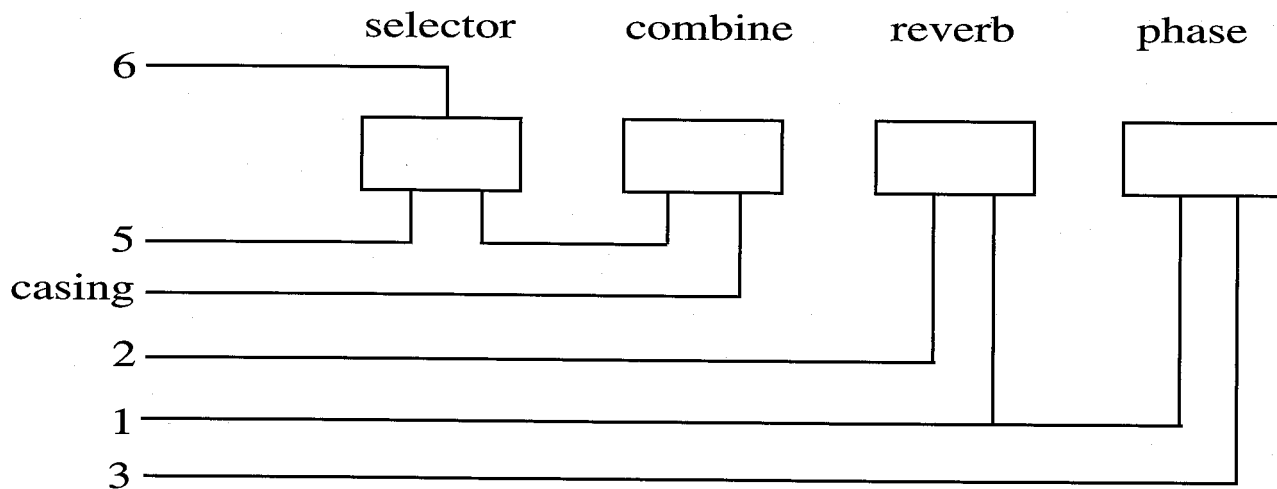

← solder side of 6 pin DIN

Automix Footswitch (Mace 1975, Deuce "B", Deuce VT, Musician MK-3, Classic "B", Classic VT, Standard B, Roadmaster "A")

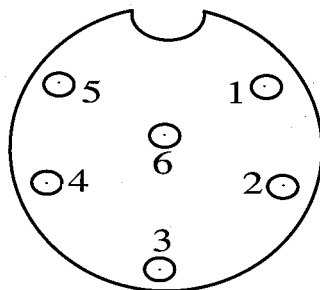
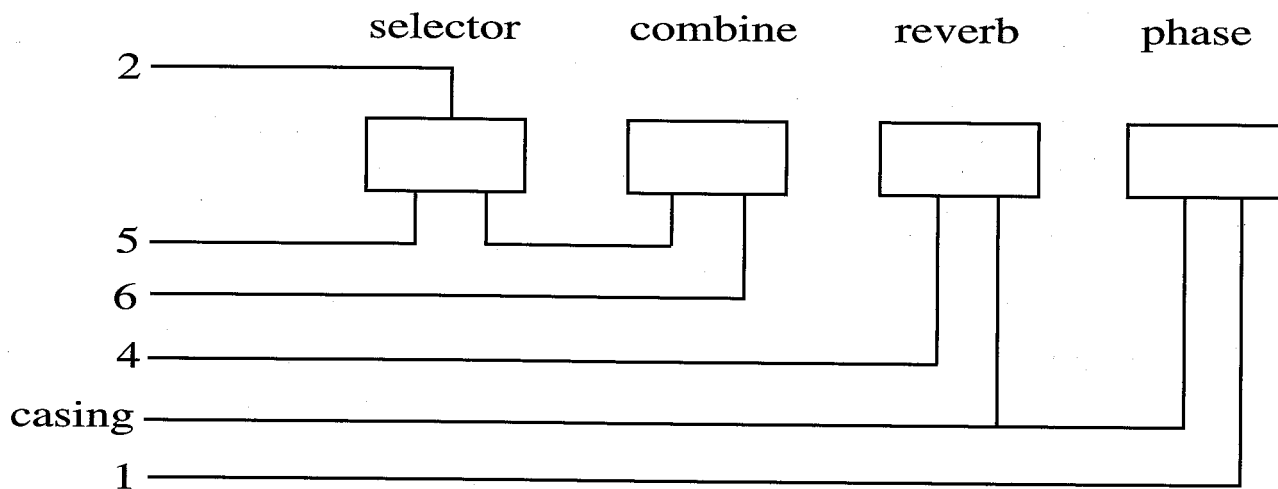

← solder side of 6 pin DIN

Studio Chorus 70/Classic Chorus 130 Footswitch

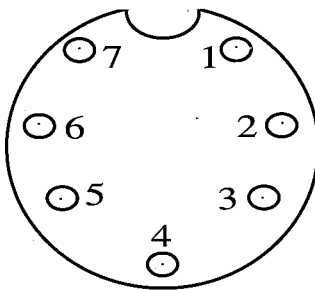
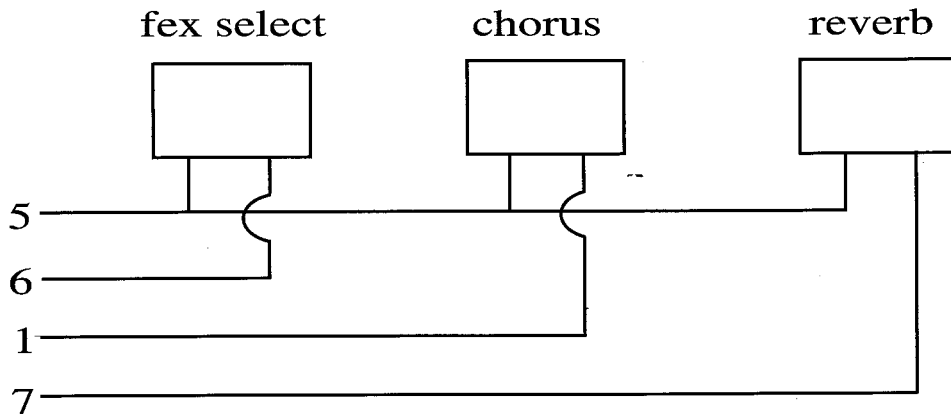

← solder side of 6 pin DIN

RENOWN/RENOWN-400 Footswitch

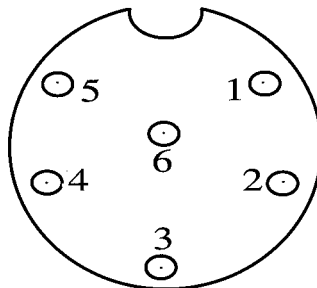
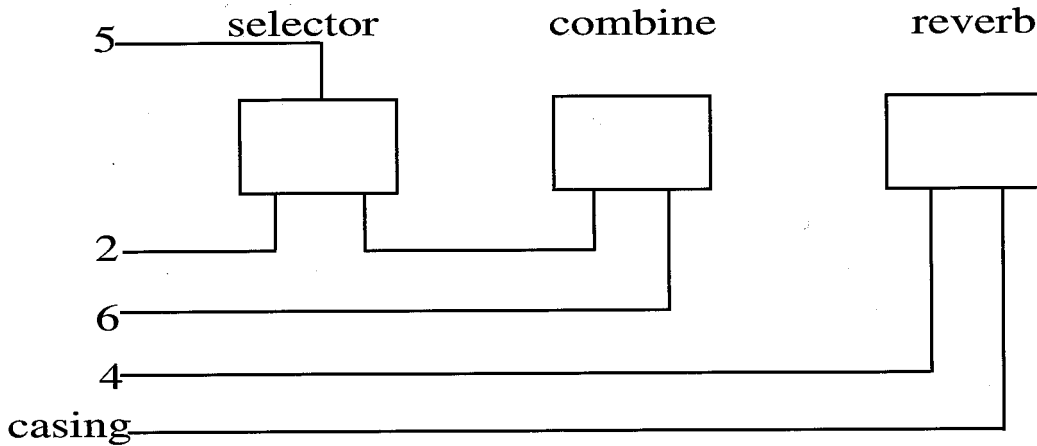

← solder side of 6 pin DIN

ARTIST, CITATION, STANDARD MK-3

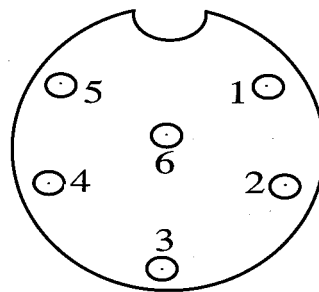
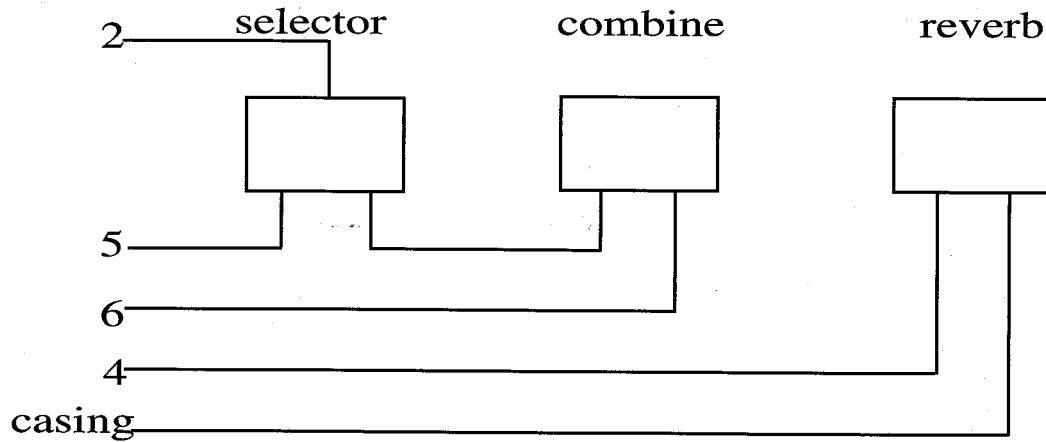

← solder side of 6 pin DIN

MS VTX Footswitch

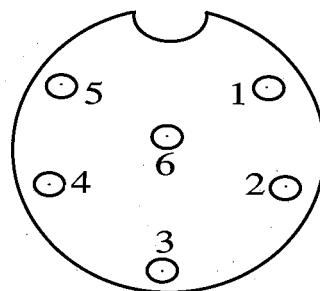
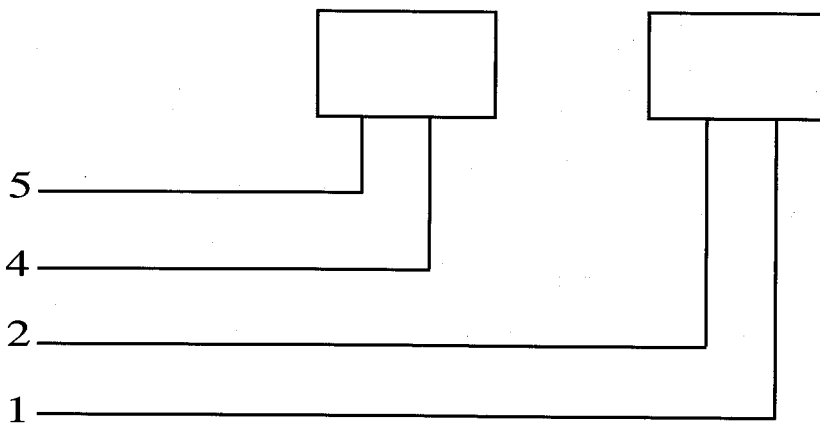

← solder side of 6 pin DIN

Austin 400

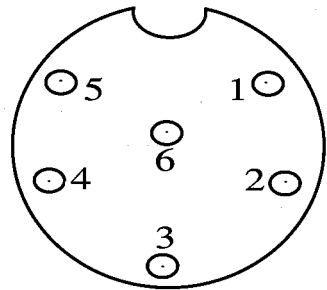
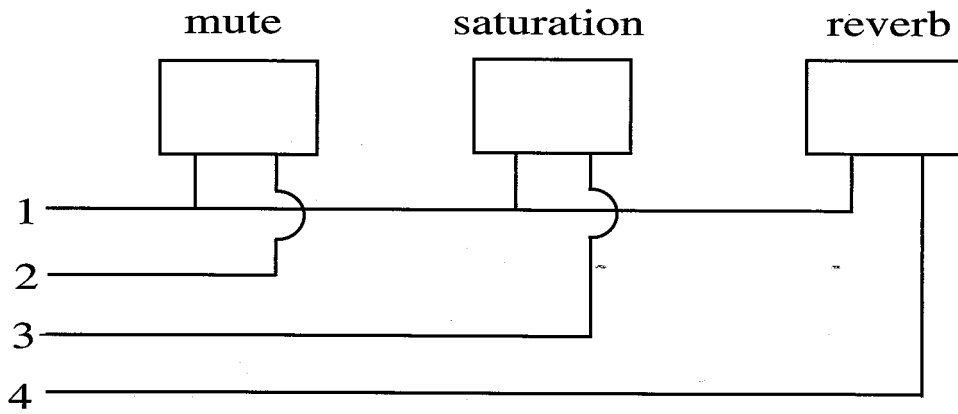

← solder side of 6 pin DIN

Session 500

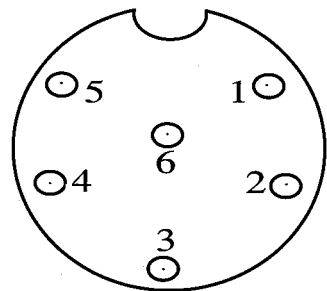
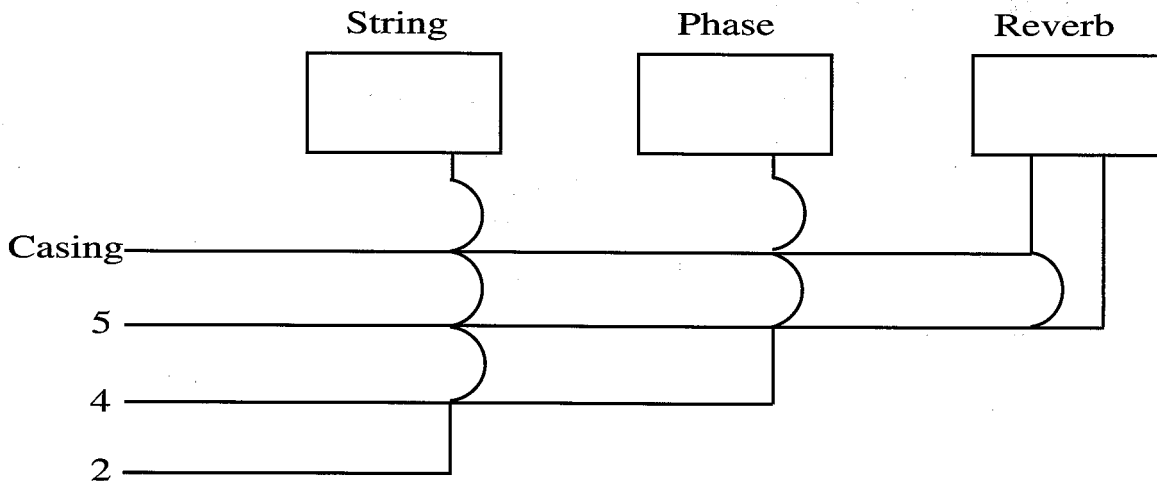

← solder side of 6 pin DIN

MUSICIAN-B 5 BUTTON FTSW

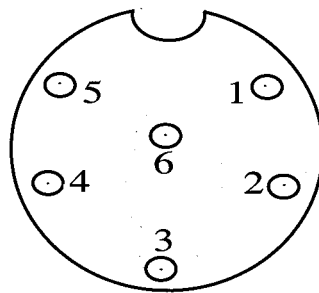
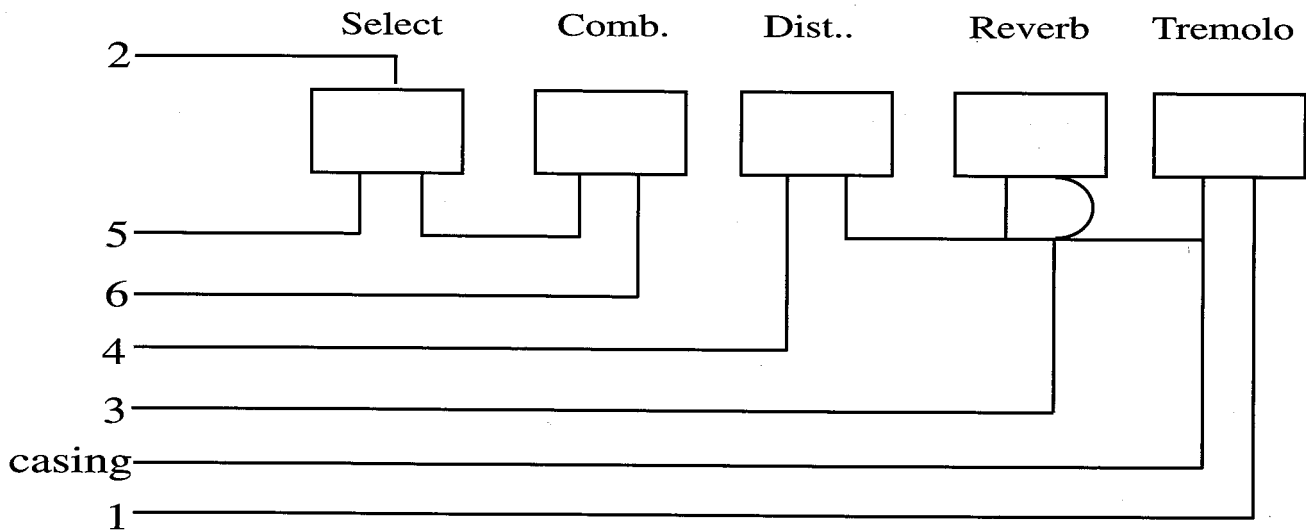

SESSION-400 LTD FTSW

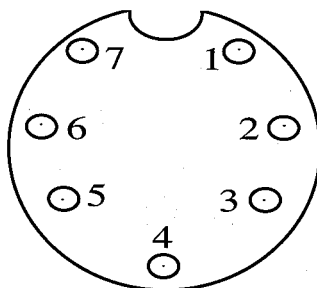
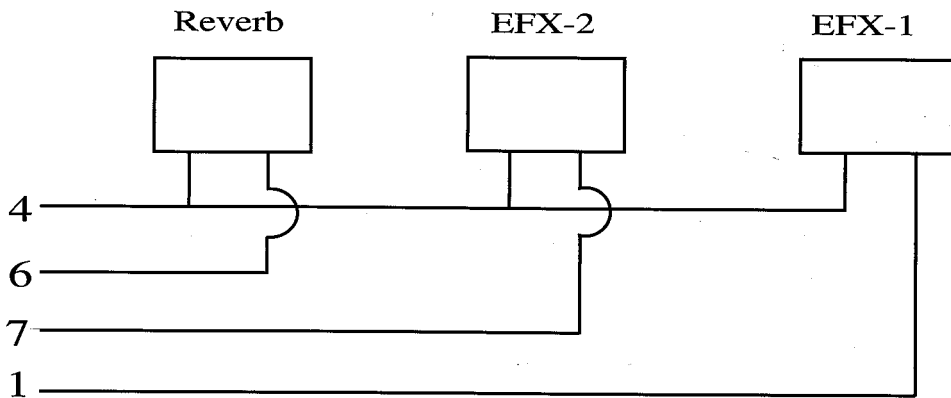

TRIUMPH PAG-60/120

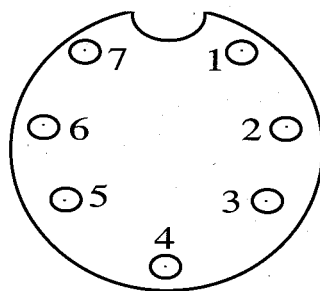
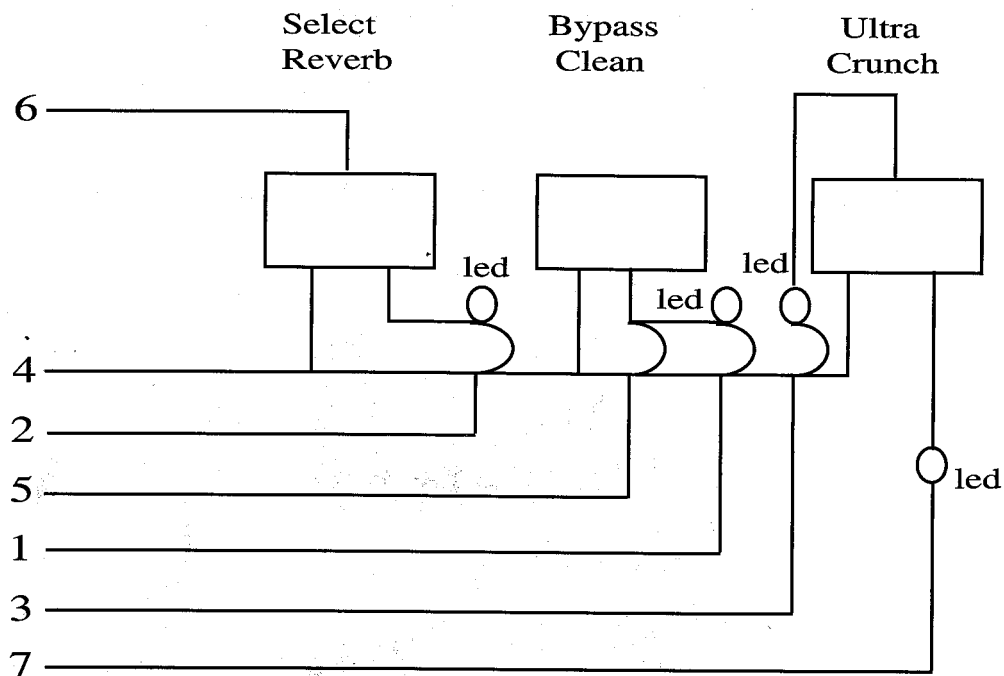

← solder side of 7 pin DIN



PEAVEY ELECTRONICS CORPORATION
 711 "A" STREET MERIDIAN, MS 39301
 (601) 483-5365 FAX (601) 486-1278