

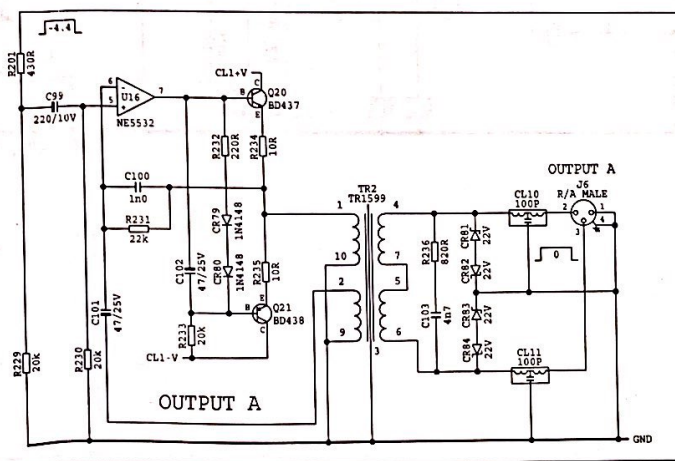

REV	DATE	CRM	REVISION
PRODUCT PURE PATH			
Langley House Third Avenue Trafford Park Manchester M17 1FG United Kingdom			
AMEK Tel No: 0161 868 2400 email: amek@amek.com Fax No: 0161 873 8010			
TITLE DUAL MIC/COMPRESSOR/LIMITER (MAIN CARD)			
DRAWN BY	JOHN PRICE	DATE	12/12/02
CHECKED BY	JOHN PRICE	SCALE	
DRAWING NO.	PP/3/007	SHEET	1
REV		NO.	7
IF IN DOUBT	ASK	REV	

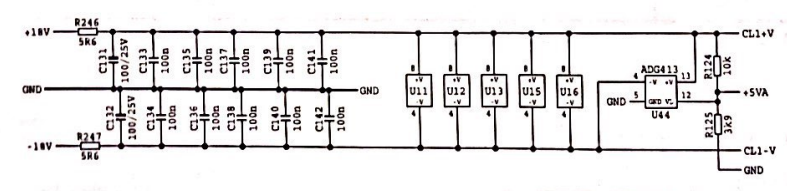

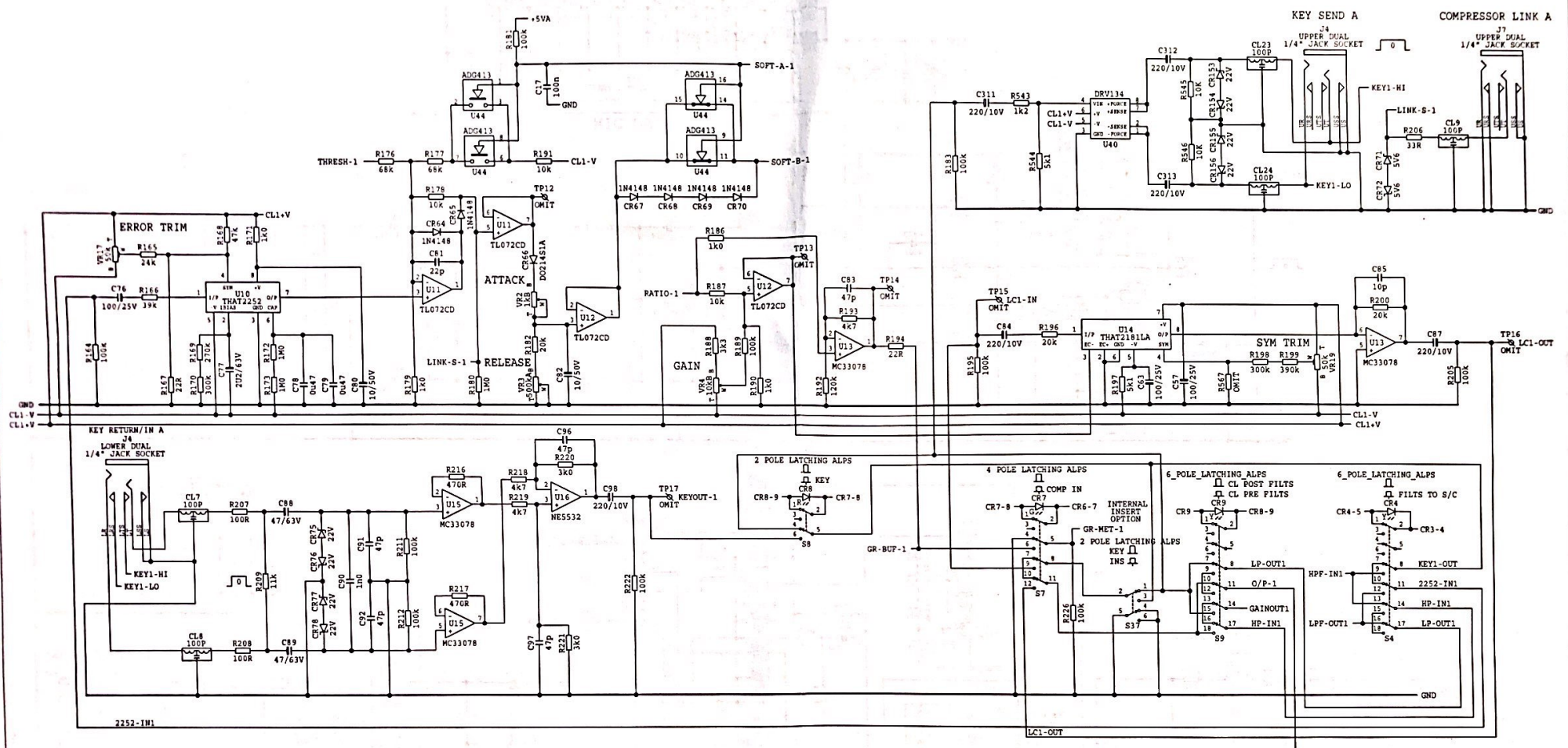

REV	DATE	CRM	REVISION
PRODUCT PURE PATH			
Langley House Third Avenue Trafford Park Manchester M17 1PG United Kingdom			
 Tel No: 0161 648 2400 email: amek@amek.com Fax No: 0161 873 8010			
TITLE DUAL MIC/COMPRESSOR/LIMITER (MAIN CARD)			
DRAWN BY JOHN PRICE		DATE 12/12/01 IF IN DOUBT	
CHECKED BY JOHN PRICE		SCALE ASK	
DRAWING NO:	SKETCH OF:	REV:	PCB:
PP/3/007	3	7	2P20148

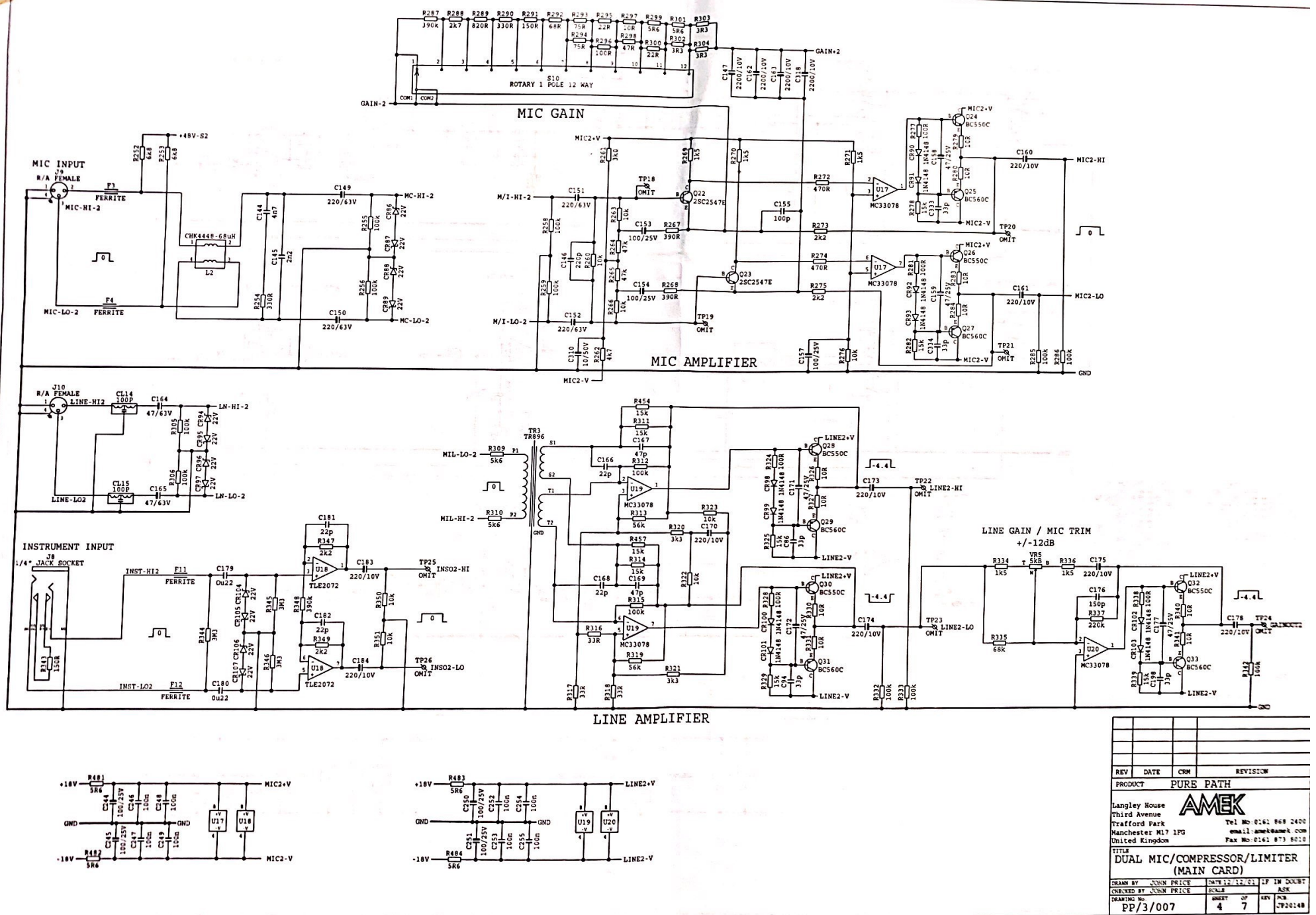

REV	DATE	CRM	REVISION
PRODUCT PURE PATH			
Langley House Third Avenue Trafford Park Manchester M17 1PG United Kingdom			
Tel No: 0161 868 2400 email: ame@amek.com Fax No: 0161 873 8212			
TITLE			
DUAL MIC/COMPRESSOR/LIMITER (MAIN CARD)			
DRAWN BY	JOHN PRICE	DWG NO	12, 11
CHECKED BY	JOHN PRICE	SCALE	IF IN DOUBT ASK
DRAWING NO	PP/3/007	SHEET OF	4 7
		REV	N/A
		DATE	17/10/80

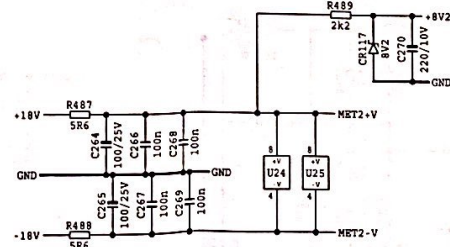
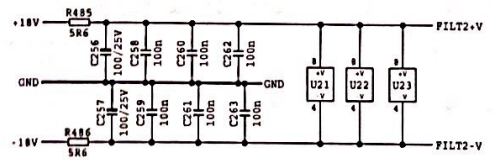
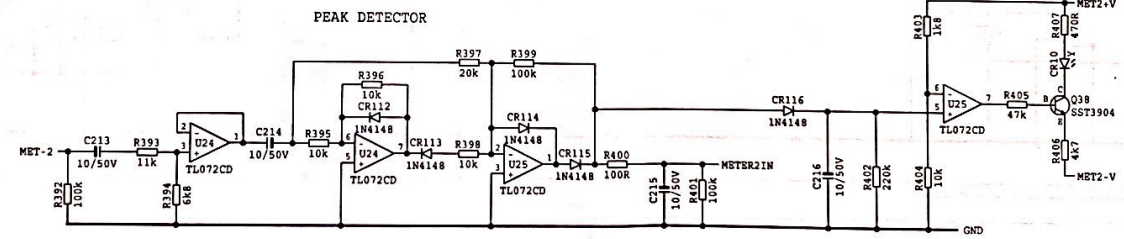
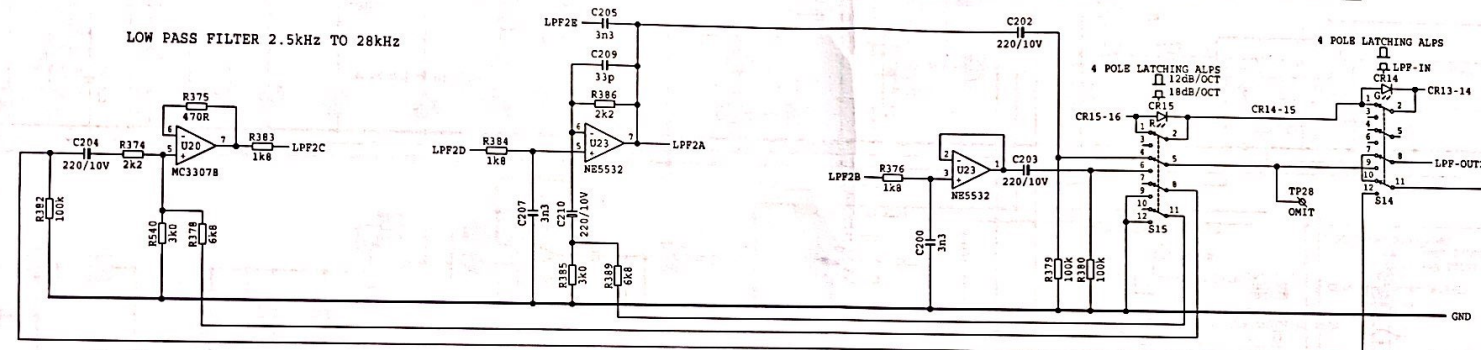
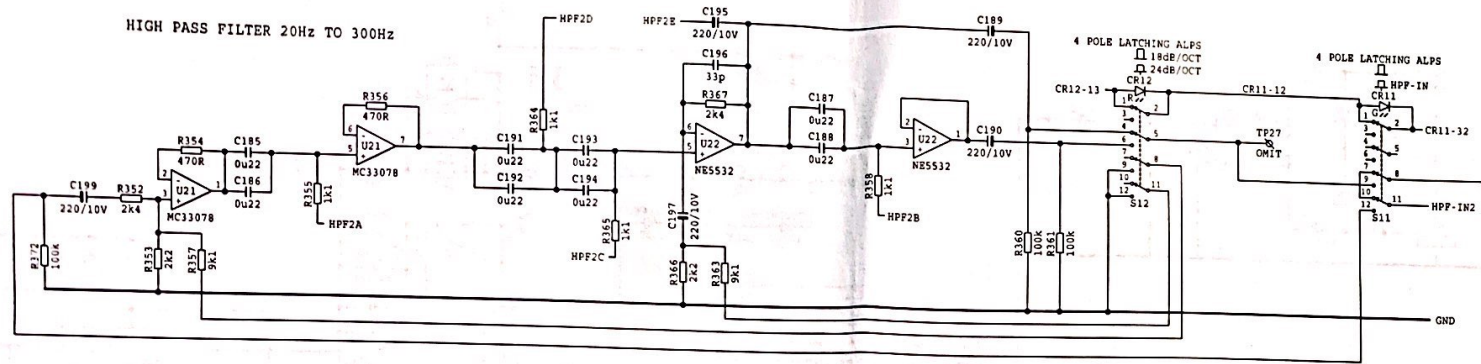



26 WAY SMD MOLEX R/A	26 WAY SMD MOLEX R/A
GAINOUT2	LN-HI-2
MET-2	LN-LO-2
MIL-HI-2	MT-LO-2
GND	HPP2A
GND	HPP2B
GND	HPP2C
MC-LA-2	MC-HI-2
INSO2-HI	INSO2-LO
GND	LFP2A
M/I-LO-2	M/I-HI-2
+48V	THRES-2
MIC2-HI	SOFT-A-2
GND	RATIO-2
	MIC2-LO
	LINK-S-2
	J23
	J24

SUB CARD LINK SUB CARD LINK

10 WAY SMD MOLEX R/A	10 WAY SMD MOLEX R/A
GND	MET2+V
GND	MET2-V
GND	MET2-2
GND	MET2-1
GND	METER2IN
GND	J22
GND	J25
GND	METER2-V
GND	METER2-2
GND	METER2-1
GND	G/R METER CARD

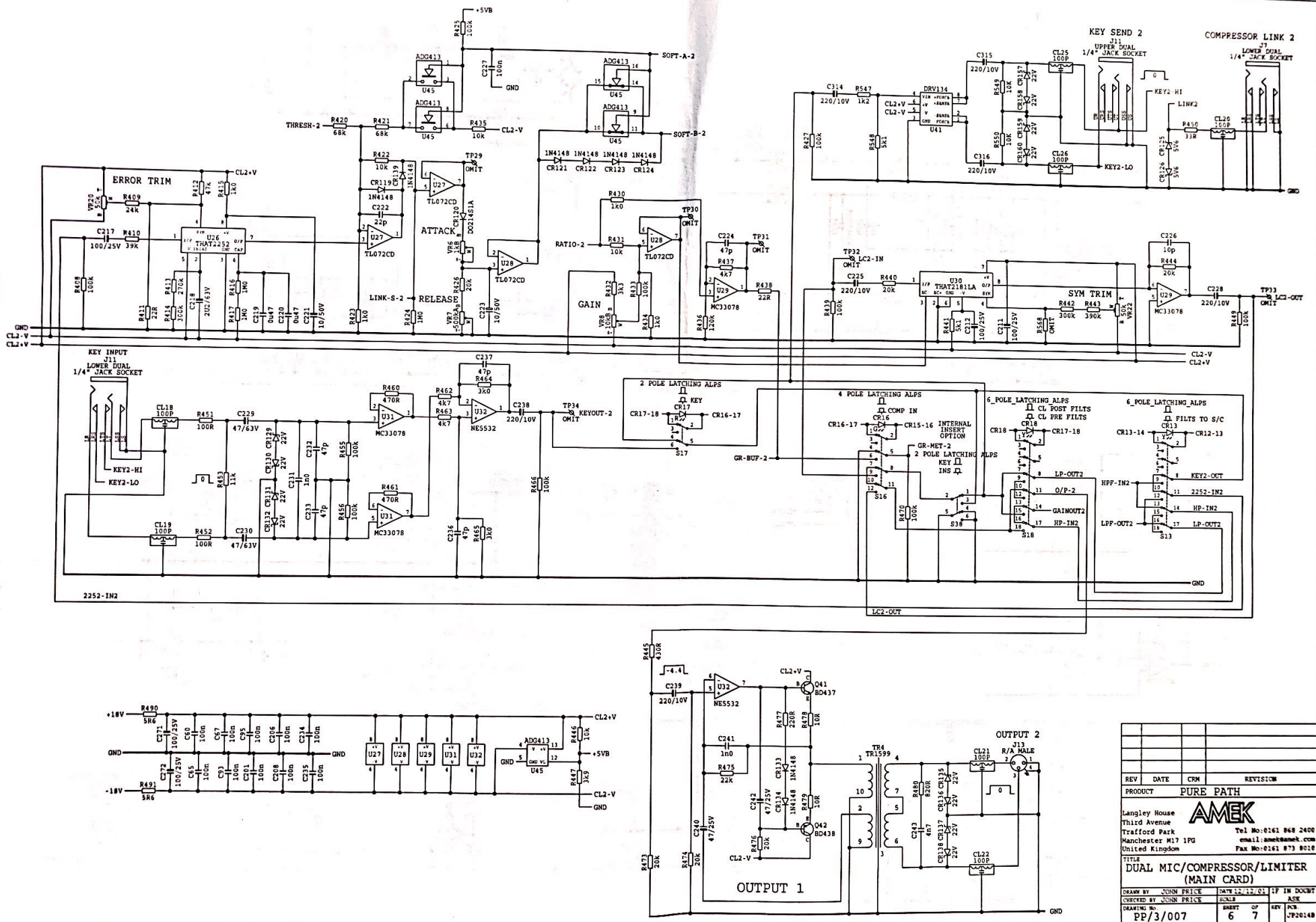
REV	DATE	CRM	REVISION
PRODUCT PURE PATH			
Langley House		Tel No: 0161 848 2400	
Third Avenue		email: amek@amex.com	
Trafford Park		United Kingdom	
Manchester M17 1PG		Fax No: 0161 873 8910	
TITLE			
DUAL MIC/COMPRESSOR/LIMITER (MAIN CARD)			
DRAWN BY	JOHN PRICE	DATE 12/12/01	IF IN DOUBT
CHECKED BY	JOHN PRICE	SCALE	AS
DRAWING No.	PP/3/007	SHEET OF	REV PCB
		5	7
			JF20148



REV	DATE	CRM	REVISION
PRODUCT PURE PATH			
Langley House Third Avenue Trafford Park Manchester M17 1PG United Kingdom		 Tel No: 0161 868 2400 email: amek@amek.com Fax No: 0161 873 8018	
TITLE DUAL MIC/COMPRESSOR/LIMITER (MAIN CARD)			
DRAWN BY JOHN PRICE		DATE 12/12/81	
CHECKED BY JOHN PRICE		IF IN DOUBT ASK	
DRAWING NO PP/3/007		SHEET OF 6 7	
		REV PCB	
		JF20148	

**WARNING !**  
 1. This symbol represents a safety critical component  
 2. No changes are allowed without prior approval by Amex.  
 3. If replaced the replacement must be of exactly the same type

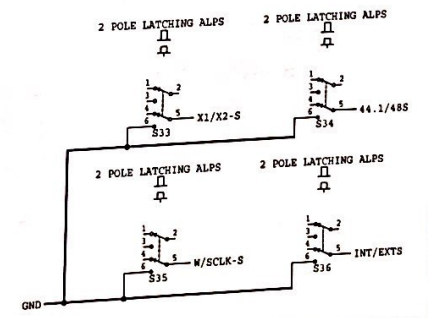
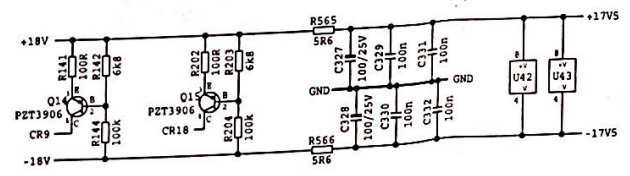
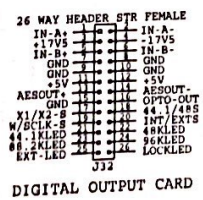
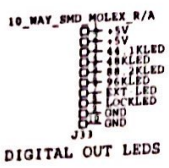
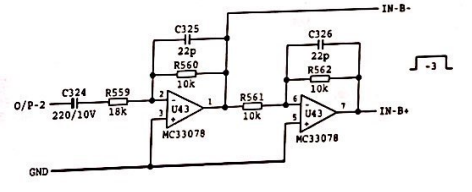
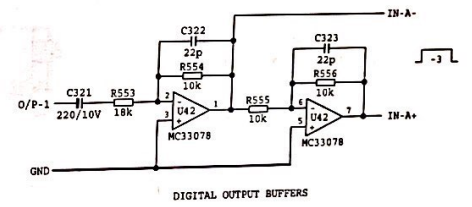
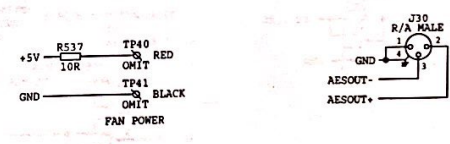
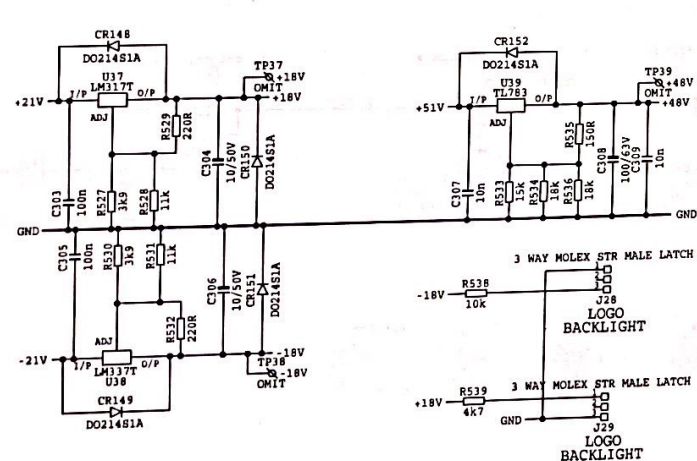
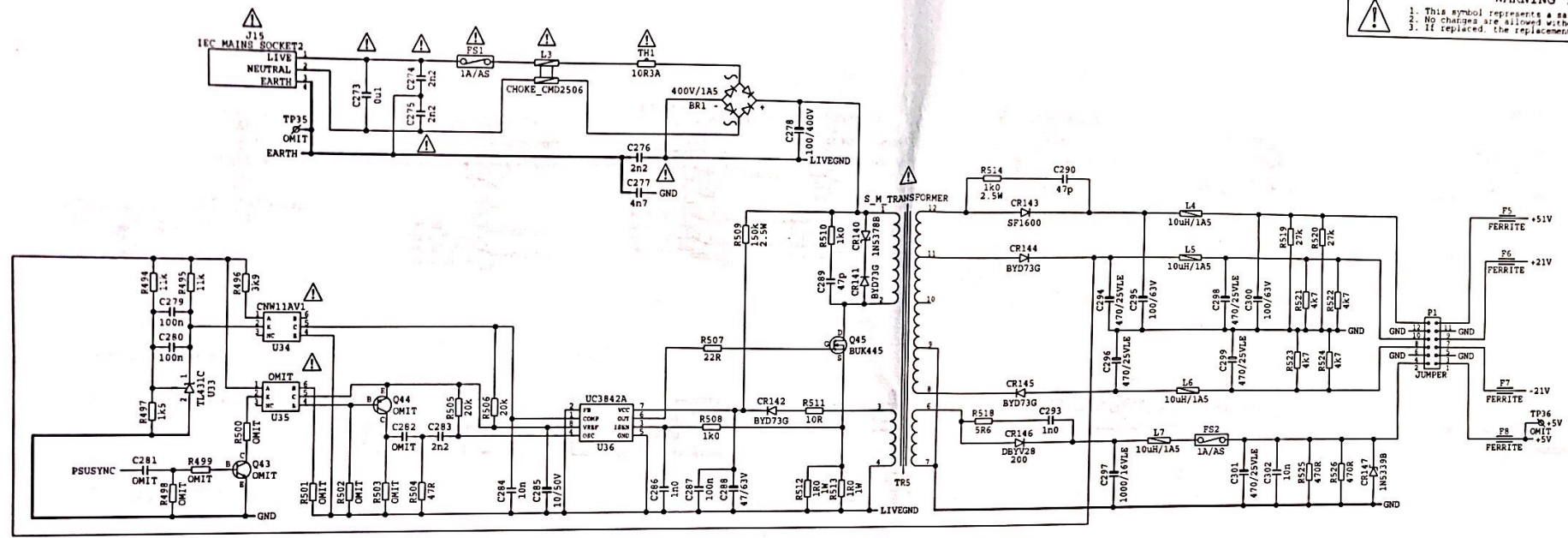

REV	DATE	CRM	REVISION
PRODUCT PURE PATH			
<b>AMEX</b>			
Langley House Third Avenue Trafford Park Manchester M17 1PG United Kingdom			
Tel No 0161 868 2400 email amex@amex.com Fax No 0161 873 8010			
TITLE DUAL MIC/COMPRESSOR/LIMITER (MAIN CARD)			
DRAWN BY JOHN PRICE	DATE 12/12/07	17 IN DRAWN	
CHECKED BY JOHN PRICE	SCALE	REV	PKB
DRAWING NO PP/3/007	SHEET 7	OF 7	REV 7
			170214B

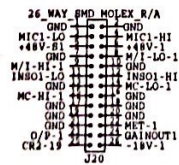
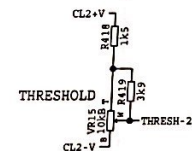
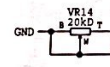
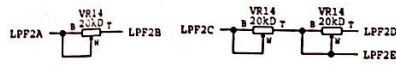
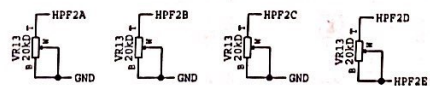
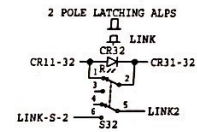
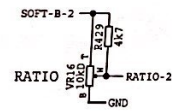
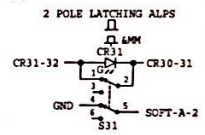
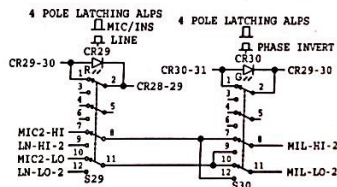
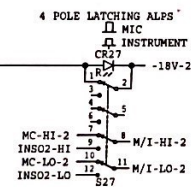
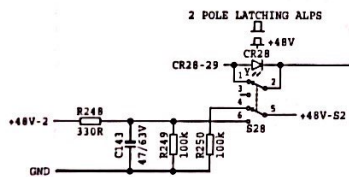
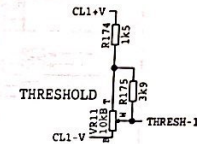
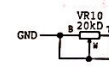
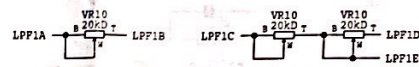
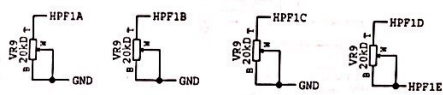
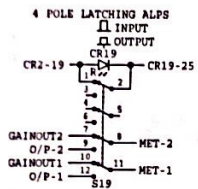
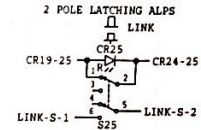
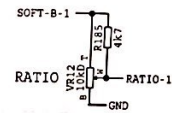
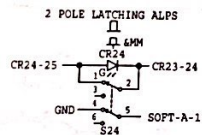
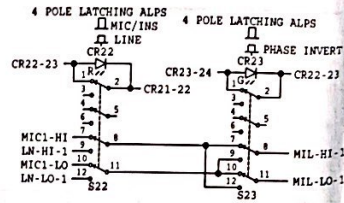
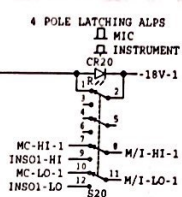
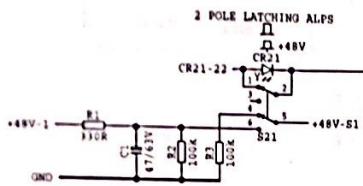

SUB CARD LINK

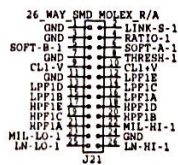

SUB CARD LINK

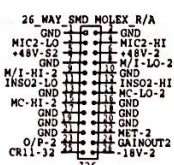

SUB CARD LINK

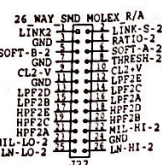

SUB CARD LINK

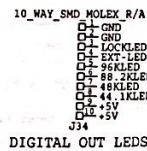

DIGITAL OUT LEDS

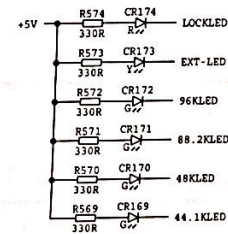

REV	DATE	CRM	REVISION
PRODUCT PURE PATH			
Langley House Third Avenue Trafford Park Manchester M17 1PG United Kingdom			
<b>AMEK</b> Tel No 0161 869 2400 email: amek@amek.com Fax No 0161 873 8010			
TITLE			
DUAL MIC/COMPRESSOR/LIMITER (SUB CARD)			
DRAWN BY	JOHN PRICE	DATE 12/12/01	IF IN DOUBT
CHECKED BY	JOHN PRICE	SCALE	ASK
DRAWING NO.	PP/3/008	SHEET	OF 1
		REV	1
		PCB	JP2015B



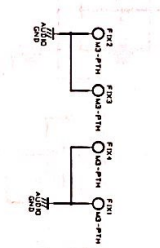
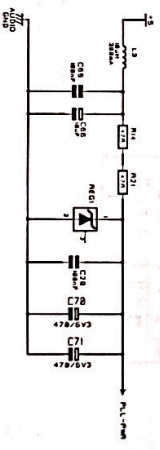
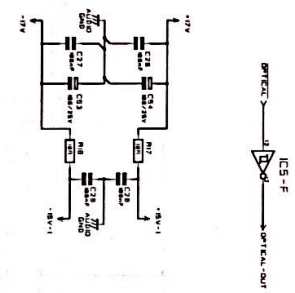
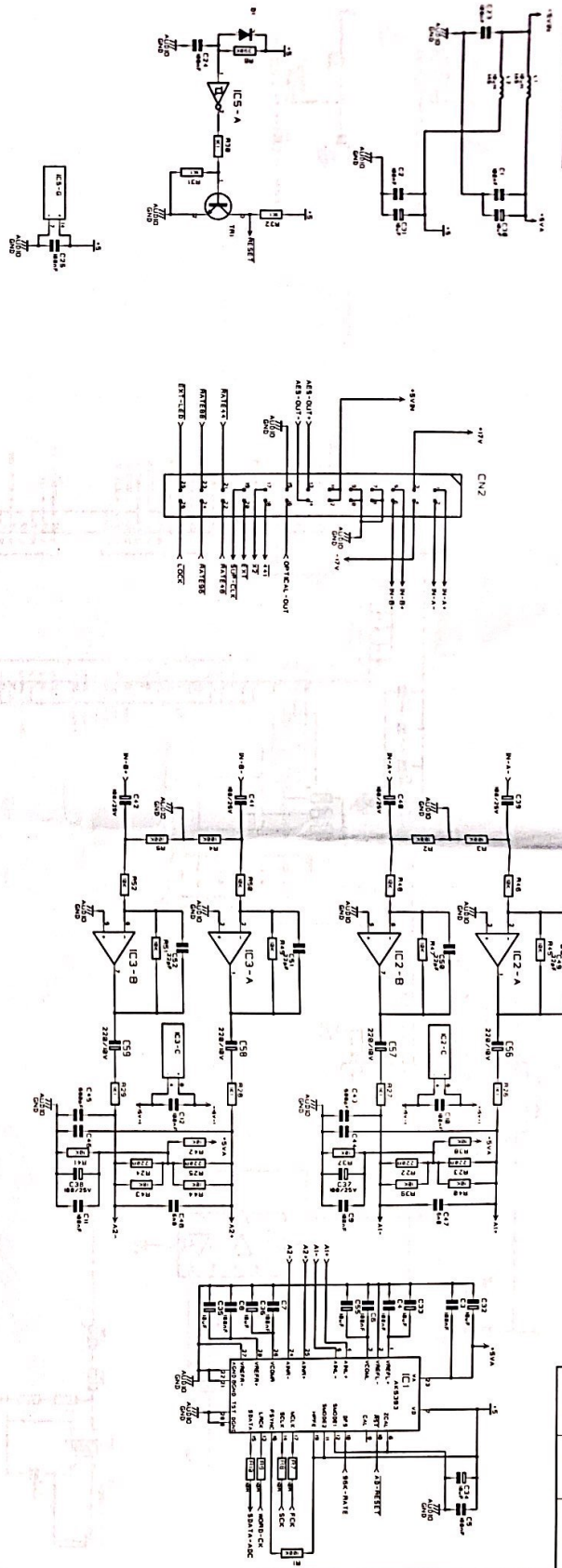

AMEK OWNS THE COPYRIGHT OF THIS DRAWING WHICH IS NOT TO BE COPIED, REPRODUCED OR TRANSMITTED IN ANY MANNER WITHOUT WRITTEN PERMISSION

NOTES  
 ISSUE 1.1 - ADDED SHEET 3 ASSOCIATED PARTS/LISTS DUE TO PCB SPACE LIMITATIONS  
 ISSUE 1.2 - REMOVED CHG 1, DUE TO JITTER PROBLEMS  
 ISSUE 1.3 - REPLACED P.L.L. DUE TO JITTER PROBLEMS  
 ISSUE 1.4 - ADDED SOFTWARE CONTROLLED RESET TO A/D + AES DRIVER

DRN. D J GERHARD  
 DATE 28-03-02  
 PCB NO 2816D

AMEK  
 HARMAN INT. INDUSTRIES LTD.  
 LANGLEY HOUSE  
 TRAFORD PARK  
 MANCHESTER M7 4AG  
 TEL: 0161 873 5800  
 FAX: 0161 873 6800

TITLE  
 DMCL DIG OUT  
 Analogue Front End  
 + ADC  
 DRG NO  
 PP/3/009

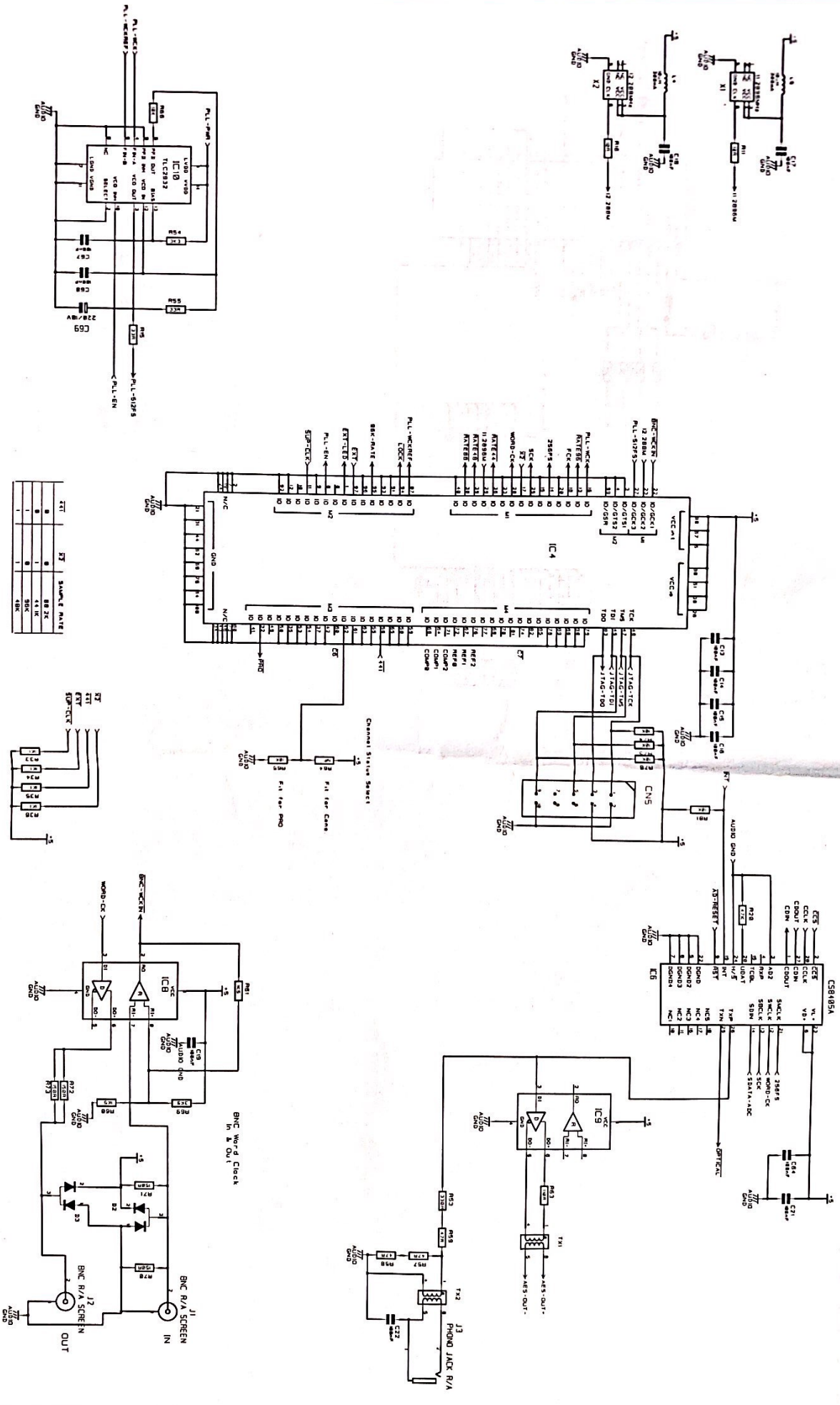

AMEK OWNS THE COPYRIGHT OF THIS DRAWING WHICH IS NOT TO BE COPIED, REPRODUCED OR TRANSMITTED IN ANY FORM OR BY ANY MEANS, WITHOUT WRITTEN PERMISSION.

NOTES  
 ISSUE 11 - ADDED SHEET 3 ASSOCIATED PARTS/LISTS DUE TO PCB SPACE LIMITATIONS  
 ISSUE 12 - REMOVED PLUG 6  
 ISSUE 13 - REPLACED PLUG 6 DUE TO LITTER PROBLEM  
 ISSUE 14 - ADDED SOFTWARE CONTROLLED RESET TO A/D + AES DRIVER

REF	QTY	SAMPLE VALUE
1	1	88 2K
2	1	4.7K
3	1	82K
4	1	10K

DRN:	D.J.GERRARD
DATE	28-03-02
PCB NO	2016D

AMEK  
 HARMAN INT. INDUSTRIES LTD.  
 LANGLEY HOUSE  
 TRAFFORD PARK  
 MANCHESTER M17 4JG.  
 TEL: 0161 868 2400  
 FAX: 0161 873 8000

TITLE	DMCL DIG OUT
DRG NO	PP/3/009
DATE	28-03-02

INITIAL	ISSUE	DATE
D/JG	14	28-03-02

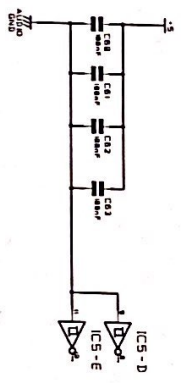
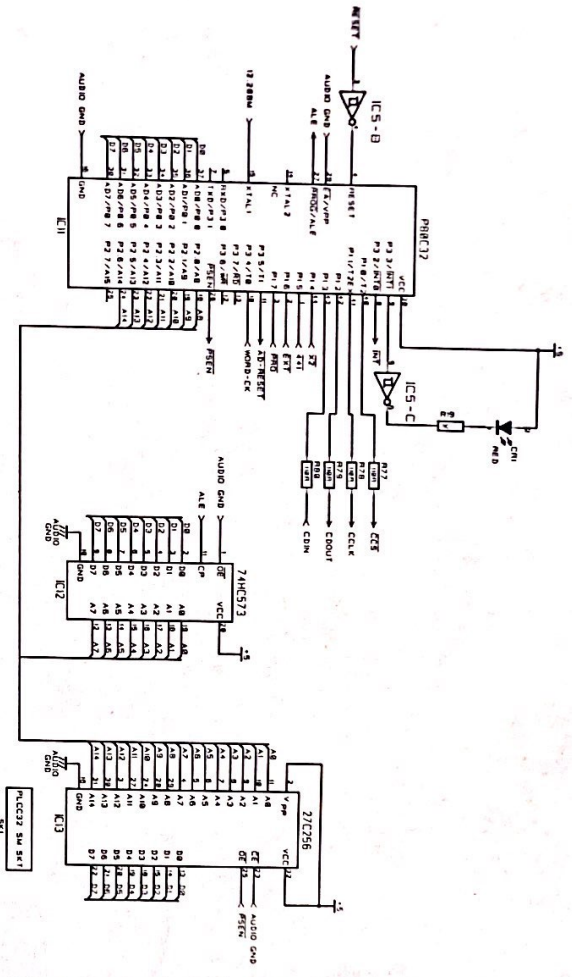

AMEK OWNS THE COPYRIGHT OF THIS DRAWING WHICH IS NOT TO BE COPIED, IN PART OR IN WHOLE TO A THIRD PARTY WITHOUT WRITTEN PERMISSION

NOTES  
 ISSUE 11 - ADDED SHEET 3  
 ISSUE 12 - REMOVED CN6 \* ASSOCIATED PARTS/NETS DUE TO PCB SPACE LIMITATIONS  
 ISSUE 13 - REPLACED PLL. DUE TO JITTER PROBLEMS  
 ISSUE 14 - ADDED SOFTWARE CONTROLLED RESET TO A/D \* AES DRIVER

DRN.	D.J GERARD	TITLE	DMCL DIG OUT
DATE	28-03-02	HARMAN INT. INDUSTRIES LTD.	MICROPROCESSOR SECTION
PCB NO	2816D	1 HARMAN HOUSE	
		TRAFFORD AVENUE	
		TRAFFORD PARK	
		MANCHESTER M13 9PL	
		TEL: 061 873 6000	
		FAX: 061 873 6010	
DRG NO	PP/3/009		