

J.B. set (single ended triode)



Created by John N. Lumley, 03/30/08 for Lumley Reference LLC

DO'S

- ☑ please connect ALL cables (especially speaker cables) before turning on
- ☑ make sure all tubes are correctly inserted in their respective sockets
- ☑ leave a few inches of space above and on the sides for ventilation
- ☑ turn on unit and allow tubes to warm up (around 30 seconds) before playing music
- ☑ when changing tubes, turn amp off first and allow the tubes to cool for a few minutes
- ☑ when leaving the house, please turn the amp off to prolong tube life
- ☑ to adjust hum, allow amp to thoroughly warm up (around 15 minutes), then attach a digital multimeter to the speaker terminals for one channel. Then set meter on the DC amps scale (to read DC milliamps). Slowly adjust hum balance potentiometer until the lowest reading is obtained. Then repeat for the other channel. This should only be necessary when changing the 300B output tubes. (The hum balance adjustment only works on the 300B tubes.)

DONT'S

- ☒ turn the amp on without all of the tubes in place
- ☒ play music without the speakers being connected
- ☒ remove or insert tubes when the amp is on
- ☒ turn the amp on and off quickly as this stresses the tubes and power supply
- ☒ touch HOT tubes; they may burn you
- ☒ use incorrect fuse sizes; the external fuse on the back is a 3 amp-Slow Blow, the internal fuse is a ½ amp- Fast Blow. Both fuses are type 3AG (1 ¼" x ¼")

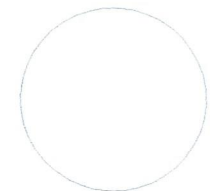
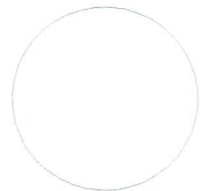
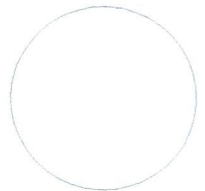
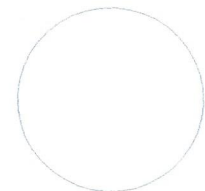
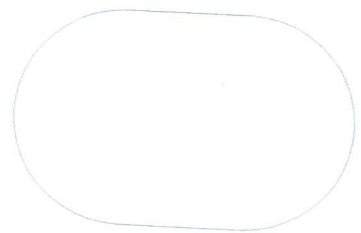
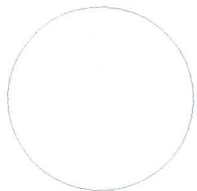

300B

5AR4/GZ34

300B



HUM BALANCE

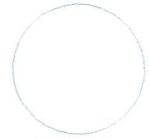

6SL7



6SL7



HUM BALANCE

J.B.set by: Lumley Reference

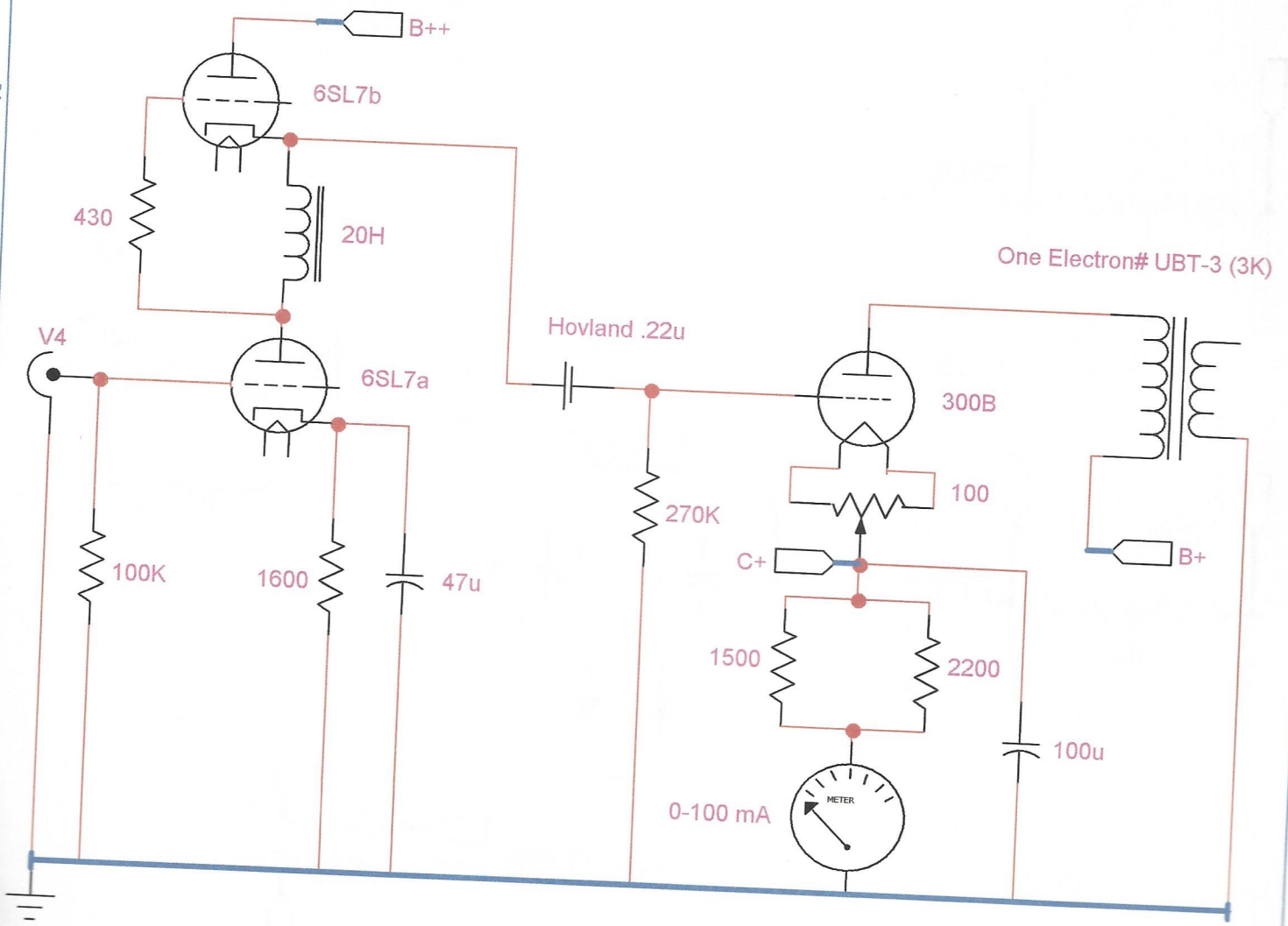

J.B. set by: Lumley Reference

TRIODE# PA-060-S (720VCT)

