

How To Modify Effect Pedals, for MAXIMUM TONE!



Designed for the absolute electronics beginner
Written by Brian Wampler
IndyGuitarist.com / ToneClonePedals.com / WamplerPedals.com

2009 Revision

Table Of Contents

Tools and Items Needed.....	8
The Basics.....	11
Basic Definitions and Concepts	11
Understanding Schematics.....	14
True Bypass in your existing pedal.....	22
All about Components.....	24
Component chart	24
Capacitor Codes.....	27
Installing pots and switches.....	29
Installing a Pot in place of a Resistor.....	30
How to use a Multimeter.....	31
How To Desolder.....	37
How To Solder.....	39
How to repair a broken solder tab on an effect pedal.....	44
Troubleshooting.....	49
How to build an audio probe:.....	51
How To Modify Guitar Pedals.....	52
General mods for nearly any pedal.....	62
How to Modify Danelectro Pedals.....	70
How to read the parts list for each modification.....	72
Where To Buy Parts.....	73
Modification Details for each pedal.....	79
Arion Tubulator.....	80
ARION MDI-2 BASS DISTORTION.....	83
BD-2 BLUES DRIVER.....	84
Boss BF-2 flanger mod.....	99
Boss CE-2 chorus.....	104
Boss CE-3 Chorus.....	107
Boss CH-1 Chorus.....	108
Boss CS-2 Compressor Modification.....	113
Boss CS-3 compressor mods.....	115
Delay pedal modifications.....	120
Boss DF-2 super feedbacker & distortion.....	121
Boss DS-1 Distortion.....	124
Boss DS-2 turbo distortion.....	134
Boss GE-7 Equalizer QUIET / Twin mod	137
Boss HM-2 mod.....	142
Boss MD-2 mods.....	146
Boss MT-2 Metalzone	152
Boss od-1 mod.....	156
Boss OD-2 R MOD.....	159
Boss OD-2 MOD.....	161

Boss OD-3.....	165
Boss odb-3 bass overdrive.....	171
Boss OS-2 Mod.....	173
BOSS SD-1 Mods.....	177
Boss sd-2 Dual Overdrive.....	189
Boss TR-2 Tremolo.....	194
Boss Xtortion XT-2.....	197
Crybaby gcb-95 wah mod.....	199
Danelectro Daddy-o.....	201
Danelectro Fabtone Mod.....	210
Digitech Bad Monkey.....	212
DOD FX60 Chorus.....	213
DOD Grunge.....	214
DOD od250/YJM308.....	216
Supra distortion FX-55B older style.....	220
Supra Distortion FX55C mod – newer style pedal.....	221
Russian Big Muff Pi Mod	224
Electro Harmonix Smallclone Chorus.....	231
Ibanez CM-5 Distortion.....	233
Ibanez DL-5 Delay Mod	234
Ibanez DS-7 Distortion.....	235
Ibanez MS-10 mod.....	236
Ibanez Powerlead PL-5.....	238
Dod FX59 Thrashmaster.....	240
Ibanez TM-5 Thrashmaster.....	242
Ibanez FZ-7 fuzz.....	244
Ibanez TS-7 MOD.....	245
Ibanez TS-5 Tubescreamer.....	248
Ibanez TS-9 TubeScreamer.....	252
TS-9DX Turbo Tubescreamer.....	258
Ibanez SM-9 Mod.....	262
Ibanez Smashbox SM-7 Distortion.....	262
Jacques Tube Blower.....	264
Johnson "Distortion plus EQ".....	265
Marshall bb-2 bluesbreaker mod.....	266
Marshall Guv'nor Plus GV-2.....	269
Marshall Shredmaster	272
Maxon OD808 TubeScreamer.....	274
Morley Classic Wah.....	276
Morley PWOV Power Wah Volume.....	278
MXR Distortion Plus (newer versions).....	280
MXR Dynacomp – Ross Mod.....	283
MXR PHASE 90 MODS	285
Nobels ODR-1 Overdrive.....	293
Nobels DT-1.....	296

Nobels ODR-B.....	298
Nobels ODR-S.....	300
Proco Rat.....	302
Rocktron Sonic Glory Overdrive.....	307
VooDoo Lab Sparkle Drive.....	312
VooDoo Labs Microvibe.....	316
Tube Driver – 3 knob version.....	317
Visual Sound Quick How-to Guide.....	319
Route 66.....	321
Jekyll & hyde (gray box version) mod.....	324
Jekyll & hyde (Red Box version) mod.....	328
Vox 847 wah.....	329
H & K Warp factor	331
<u>In Closing.....</u>	334
<u>Contact Information.....</u>	335

Disclaimers:

Warning Disclaimer: These modifications are recommended for persons over the age of 18. If you are under 18, you should have adult supervision before attempting modifications. Please use safety precautions when modding, using tools and soldering. We are not to be held responsible if you get hurt, hurt someone else or destroy property. By viewing any of the links below you comply with the above statement and fully realize any risks that may be involved with performing any of the modifications listed. Always wear safety protection and follow safety guidelines and directions on products. Solder can pop in your eyes, burn skin, etc. Some materials used in guitar pedals can be harmful if inhaled. Batteries can explode acid on your skin and clothing. USE PRECAUTIONS, READ DIRECTIONS AND ALWAYS WEAR SAFETY PROTECTION.

By following the directions in this book, you agree to not hold any person, party, or company associated with this book including, but not limited to Brian Wampler, Guitartone.net, Indyguitarist.com, or any person, party, or company associated with them. You also agree that you are over age 18, of a sound mind, and take full and complete responsibility for your actions.

Boss TM, Ibanez TM, MXR TM, Fulltone TM, Visual Sound TM, Tubeworks TM, Tonebone TM, Danelectro TM, Voodoo Labs TM, Vox TM, Hughes & Kettner TM, Electro Harmonix TM, DOD TM, Dunlop TM, Morley TM, Crybaby TM, Marshall TM, Proco Rat TM, Arion TM, Nobels TM, Mesa Boogie TM, Bogner TM, and any other company mentioned here are used respective of their trademark.

Special thanks to: Andy Carrol of Dragonfly FX, Aron Nelson of <http://www.diystompboxes.com>, Jack Orman of www.muzique.com, RG Keen of www.geofex.com, Nero, Johan, MartyMart of Aron's forum, Dirk Hendrik, all of those that contributed schematics (links are given where applicable), Mark Hammer of hammer.ampage.org, colin of experimentalistsanonymous.com, and anyone else I may be forgetting!

All images copyright by their owner where listed, and by Indyguitarist.com © 2002-2007
All intellectual property copyright © 2002-2007 by Indyguitarist.com

For updates, make absolutely sure you email diy-kit-updates@getresponse.com to be notified first.

Introduction

The spirit of DIY (do it yourself) is stronger now than it ever has been. The possibilities have really exploded with the arrival of the internet. In guitar effects specifically, it is easier now than it ever has been to build OR modify your own effect pedals (for ANY instrument), and make them sound MUCH better and work MUCH better for your needs than any other mass manufactured pedal.

A quick lesson on this: Most mass manufacturers of guitar pedals have several engineers or a department of engineers whose job is to come up with a decent sounding circuit for a given need. These ideas are largely math-driven, meaning that 'on paper' it "should" sound good for the largest percentage of their customer base or at least good enough until that consumer grows tired of the particular pedal and buys a different one. Honestly, even if they DID set up circuit using their ears instead of calculators, you probably won't like it then either – many of the engineers working for these companies aren't musicians, and/or don't have the ability to notice how a pedal can 'react' or sound differently with different modifications done to it. Sort of like eating at a restaurant where the chef or cook doesn't have any taste buds. In addition, the products are generally scrutinized closely to figure out how to cut costs – most often by using the cheapest parts available at the time, not ones that are necessarily the best for tone.

The truth is that modifying guitar pedals is NOT hard, once you understand the basics. Unfortunately, many of the DIY communities and books would rather you learn the way *they* did...by trial and error and/or reading Electrical Theory books and trying to absorb it somehow.

It is my goal to lead you to the wonderful but addicting hobby of using your own two hands to create tones that make you have a hard time putting down the guitar...the sounds, tones, and dynamics that guitar pedals SHOULD have but don't always.

I'm not going to dive into a ton of theory – that really isn't the intent of this book, and it is unnecessary if you want to simply modify some pedals for yourself and/or your friends. Once you have read this book and are comfortable with modifying pedals, if you wish to dive in further, you may want to check out my other books at www.guitartone.net and even amplifier mods at www.DIYampmods.com

A big thank you to everyone who's contacted me, and supported our DIY cause! Now, let's dive into the 2009 revision of the Indyguitarist / Guitartone.net "DIY How-to modify effect pedals Guide!"

Tools and Items Needed



You will need to have/purchase a few basic items first in order to start correctly, but keep in mind that all of these things are “one-time” purchases and should last you a very long time. These items listed below are the exact ones that I used to get started and are all found at your local Radio Shack, but I HIGHLY recommend buying them from www.smallbearelec.com - not only are the parts and tools a much higher quality, but in many cases less expensive as well.

First, I must assume that you have access to or plan on purchasing: needle-nose pliers, wire cutters, and a drill (if installing larger led's).

30-40 Watt soldering iron (look for one with a grounded tip, a good feature to have)

60/40 rosin core solder

De-soldering braid

De-soldering pump (optional, but makes it easier to desolder)

colored felt tip markers (sharpie's work great)

Digital Multimeter

Go to www.smallbearelec.com to buy these products.



A high quality solder iron is your best bet – cheaper radio shack ones will work, but I've found these Wellers to be top notch for this type of work.

PRODUCT FEATURES:

<http://www.smallbearelec.com/Detail.bok?no=378>



If you don't have much in the way of tools, you would probably want to get this, unless you can borrow a few of the basic tools.

<http://www.smallbearelec.com/Detail.bok?no=390>



If you have a few extra dollars to spend, you may want to think about getting a workstation like one of these:

I recommend using a soldering station like one of these, if you are going to be modifying more than one or two pedals.



<http://www.smallbearelec.com/Detail.bok?no=378>

****Absolutely, without a doubt, do not use one of the solder irons that advertises the ability to solder without heat. Using them makes it very, very easy to tear up a circuit board in a hurry!**



Solder is the 'glue' that holds the parts onto the circuitboard. Here is what I recommend:
<http://www.smallbearelec.com/Detail.bok?no=382>
Desoldering Braid is what you will use to desolder parts if you need to for any reason. Here is the one I recommend:



<http://www.smallbearelec.com/Detail.bok?no=383>

Catalog #: **64-005**
Catalog #: **64-2090**



Radio Shack:
Catalog #: **64-2951**
Catalog #: **64-2980**



<http://www.smallbearelec.com/Search.bok?category=Tools+-+Pliers+and+Cutters>

The Basics

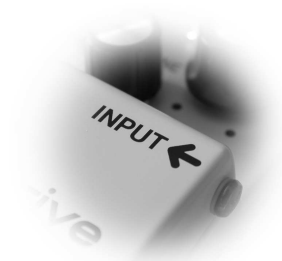

Let's get started...

Modifying a guitar pedal is really not a hard thing to do. Once you follow a few simple rules and become familiar with the internal parts of a pedal, you will have no problem at all.

Many mistakenly think that they need to go to college or a trade school to learn how to do this. We'll dispel this myth and show you just how easy it is.

Basic Definitions and Concepts

Let's take just a minute and go through the basics of electrical circuits. Anytime you have an electrical circuit, you have voltage and current. By building circuits, you are able to control voltage and current.

~Current

Current is what flows through a wire. Think of it as water flowing in a river. The current flows from one point to another point just like water in a river.

The unit of measurement for current is the Ampere, or Amp for short, and abbreviated as A. Common currents are 0.001 Amps (0.001A) to 0.5 Amps (0.5A). Since currents are usually small, they are usually given in the form of milliAmps (abbreviated mA.) The prefix "milli" means divided by 1000, so 0.001 Amps equals 1 milliAmp (1 mA). Likewise,, 0.5 Amps equals 500 milliAmps (500mA).

~Voltage

Voltage indicates the power level of a point. Voltage is measured in volts. Using the water analogy, a point at the top of a hill would be at a high voltage level and a point at the bottom of a hill would be at a low voltage level. Then, just as water flows from a high point to a low point, current flows from a point of high voltage to a point of low voltage. If one point is at 5 volts and another point is at 0 volts then when a wire is connected between them, current will flow from the point at 5 volts to the point at 0 volts.

We call the lowest voltage in a circuit zero volts and give it the name ground. Then all other points in the circuit are compared to that ground point. Rivers always flow towards sea level and currents always flow towards ground.

A battery is similar to a dam. On one side is a lot of stored up energy. When a path is formed from that side to the other side then current flows. If there is no path then current does not flow and the energy just stays there waiting for a path to form to the other side. The path can be a big path with lots of current flowing or a small path with just a little bit of current flowing. With a dam, a little bit of water flow could go on for a long time, but flow through a big path that lets all the water go at once would only last a short while. A battery is the same. If there is big path from the high voltage side to the low voltage side then the battery will not last long. There are two special cases that we give names. One is when the current is zero (open circuit) and the other is when the voltage is zero (short circuit).

~Open Circuit

An open circuit is when two points are not connected by anything. No current flows and nothing happens. If a wire in your vacuum cleaner breaks it can cause an open circuit and no current can flow so it does not do anything. There may be a voltage between those two points but the current cannot flow with out a connection.

~Short Circuit

A short circuit (or short) is when two points with different voltage levels are connected with no resistance (see resistors) between two points. This can cause a large amount of current to flow. If a short circuit happens in your house, it will usually cause a circuit breaker to break or a fuse to blow. If there is no device to limit the current, the wires may melt and cause a fire. This situation is something like a dam breaking. There is a large amount of energy suddenly free to flow from a high point to a low point with nothing to limit the current.

~Series Connection

A series connection is when two components are joined together by a common leg and nothing else is connected to that point as shown below.



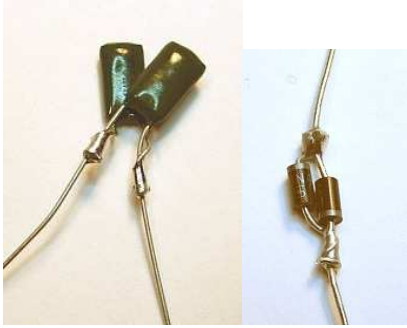

~Parallel Connection

A parallel connection is when two components are joined together by both legs as shown below.



Understanding Schematics...

Schematics are basically electrical roadmaps, showing a person how a circuit is connected and uses funny looking symbols. Let's take a closer look at some of the most common symbols in guitar pedals.

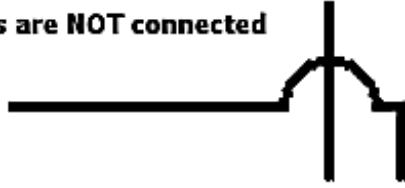
 	<p>Connect to ground; i.e. take all the points pointing to ground, connect them together, then connect them to the ground lug of the input jack. Take the power supply (9v jack and/or battery) and connect the ground side of it to this same spot..</p>
<p>Connections are shown at the right. Pretend as if between each part is a wire. If two wires cross and are connected, you sometimes will see a round dot at the intersection or they will simply cross each other.</p> <p>If they are not connected you will see on of the wires appear to go over a 'bridge' or make a half circle around the other wire at the intersection.</p>	<p>Wires are connected: </p> <p>Wires are NOT connected: </p>

Resistors

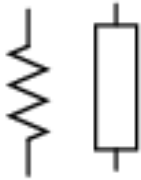

Resistors are not directional, and come in many different values, sizes, and several different types. Many pedal builders like to use 'metal film' resistors insisting that they are quieter. Others like the sound of carbon composite or other carbon based resistors.

Resistors are not directional, so there is no certain direction they need to be oriented.

Each resistor has colored bands on them. You can use these bands to determine what value your resistor is.

Some resistors have 4 bands, and some have 5 bands of colors.

If you go www.GuitarTone.net/calculator you will be able to enter the colors into the webpage and it will tell you what value your resistor is.

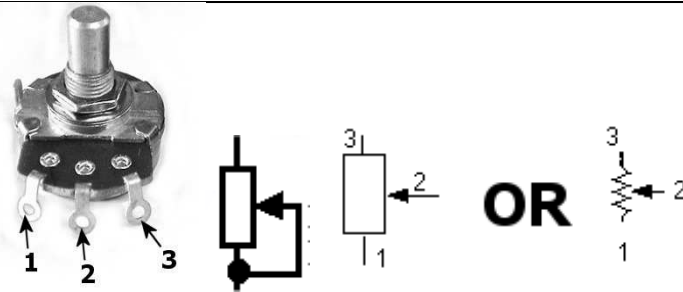

Potentiometers (also called 'pots'), which can also be thought of as a 'variable resistor'. This is what knobs attach to.

Pots come in different tapers. The ones we use most are audio tapers and linear tapers. Why different tapers? Gain and tone knobs are generally linear taper. Volume controls are audio taper. This is because the human ear does not respond linearly to loudness. It responds to a "logarithm" of loudness.

According to RG Keene of www.geofex.com, that means that for a sound to seem twice as loud, it has to be almost ten times the actual change in air pressure. For us to have a control pot that seems to make a linear change in loudness per unit of rotation, the control must compensate for the human ear's oddity and supply ever-increasing amounts of signal per unit rotation. This compensating resistance taper is called an audio or log pot. In these pots, the wiper traverses resistance very slowly at first, then faster as the rotation increases.

If you used an audio/log taper pot for the control of the power supply we mentioned, the output voltage would increase very slowly at first, creeping up to maybe 10% of the final output at 50% of the pot rotation. It would then blast the other 90% in the last half of the rotation which isn't very handy when trying to control volume.

Capacitors ("caps")

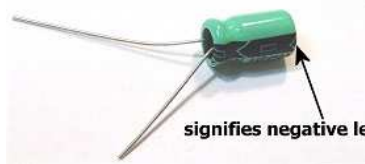

Capacitors basically block DC. What this means for an effect circuit is that it acts as a filter of sorts. Wiring a resistor or pot in conjunction with a cap will result in equalization controls.

Positive Side

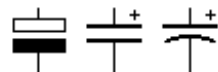

Negative Side

Polarized Cap

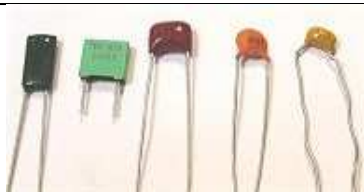

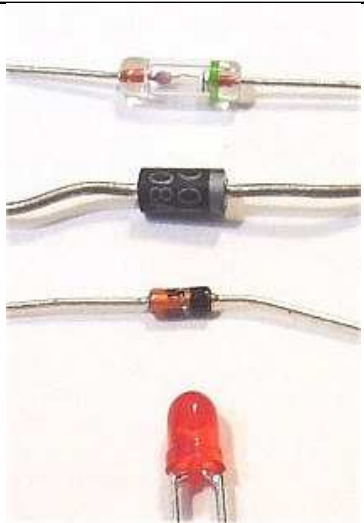

Bi-Polar (no positive or negative Cap)

Diodes

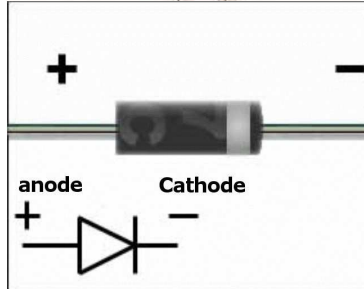

Diodes are components that allow current to flow in only one direction. They have a positive side (leg) and a negative side. When the voltage on the positive leg is higher than on the negative leg then current flows through the diode (the resistance is very low). When the voltage is lower on the positive leg than on the negative leg then the current does not flow (the resistance is very high). The negative leg of a diode is the one with the line closest to it. It is called the cathode. The positive end is called the anode.

Diodes do many different functions. Overdrive, distortion and some fuzz pedals will use them to 'clip' the signal, creating the distortion effect. Led's, which are "light emitting Diodes" can be used for the same thing, and in some circuits will actually light up when signal is present.



LEDs use a special material which emits light when current flows through it. Unlike light bulbs, LEDs never burn out unless their current limit is passed. They have a positive leg and a negative leg just like regular diodes. To find the positive side of an LED, look for a line in the metal inside the LED. It may be difficult to see the line. This line is closest to the positive side of the LED. Another way of finding the positive side is to find a flat spot on the edge of the LED. This flat spot is on the negative side.

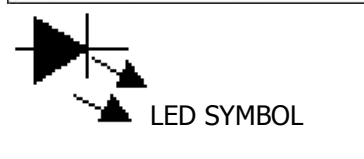

The main reason for using different diodes for clipping is that they will all sound different, and clip the signal a little bit differently. Experimentation is the key here. LED's are of course used to signify if a pedal is on or off as well, simply by turning on the voltage going to the LED.

Diodes are also used in other places, such as protecting against using the wrong current, or polarity in a power supply. There are many types of diodes – the main ones we'll be using are germanium 1n34a's, 1n4001 (which works the same as the 1n4002, 1n4003, 1n4004, etc when used as clipping diode) and 1n914/1n4148 (same thing basically).

Transistor

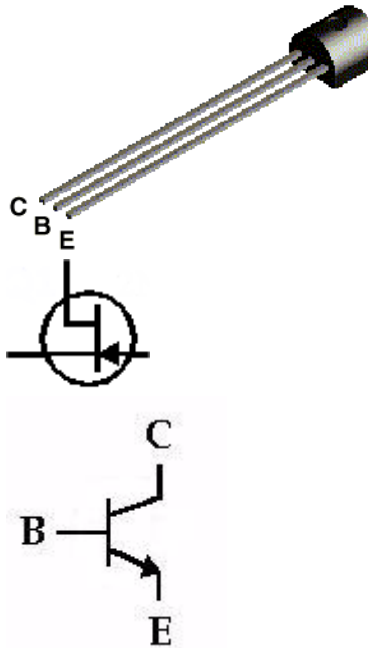

Transistors are basic components in all of today's electronics. They are just simple switches that we can use to turn things on and off, but can be arranged in a certain way in conjunction with other components and will amplify an audio signal.

The transistor has three legs, the Collector (C), Base (B), and Emitter (E). Sometimes they are labeled on the flat side of the transistor. Transistors always have one round side and one flat side. If the round side is facing you, the Collector leg is on the left, the Base leg is in the middle, and the Emitter leg is on the right, but always check the datasheet pinout for the particular transistor you are using since these pinouts can differ.

Another type of transistor is the FET types, JFET or Junction Field Effect Transistor and MOSFET or Metal Oxide Semiconductor Field Effect Transistor. FETs are transistors with a very high input resistance. They have three terminals: Drain, Gate and Source. Many popular distortion, overdrive, and clean boost circuits are made with FETs.

Jacks

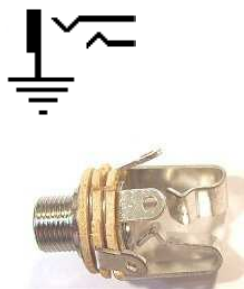

Stereo Jack

Most often used when you want your pedal's power to disconnect when you unplug your guitar cable from the pedal. What you will do is connect the power's ground wire to the sleeve connection. Whenever a plug is inserted in the jack, this will make the power's ground go down the plug sleeve, connect to the ring connection which is connected to the rest of the circuit's ground.

ring

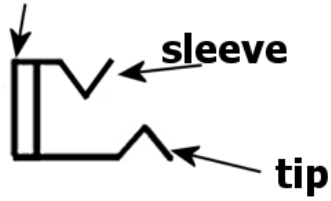

Mono Jack

If you are using a 9v adaptor jack on your pedal and not a battery connection, I recommend just using mono jacks, simply because they are generally less expensive and easier to use when you are first starting out.

IC chip, op-amp

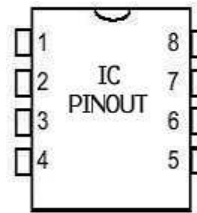
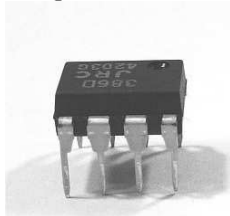
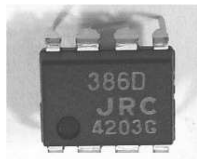
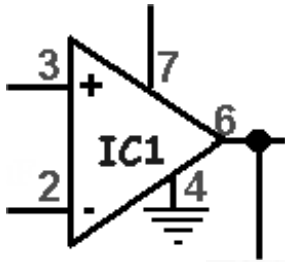

Integrated circuits (ICs) are, much as their name would suggest, small circuits integrated into a plastic "chip." They provide a handy source of rich functionality in a tiny package. Opamps, which are a type of integrated circuit, are primarily designed as voltage amplifiers meaning it will amplify a signal.

When installing IC chips, always use an IC socket. This will allow you to swap the chips to a different kind should you need to. Also, it is much safer to use the IC socket since most IC chips are very sensitive to heat.

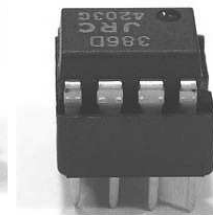
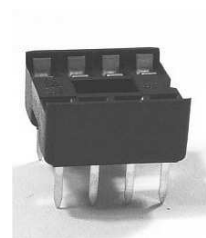

Switches



There are several different types of switches that we will use for stompboxes. 3pdt (triple pole, double throw), dpdt (double pole, double throw), spdt (single pole, double throw), and spst (single pole, single throw).

Out of all these, there are only two that we will use for the stomp (bypass) switch, the 3pdt and the dpdt. Most use the 3pdt because it allows you to easily connect a LED to indicate if the pedal is on or not. A dpdt can also be used but additional circuitry is required to turn the LED on and off.

The picture above shows a 3pdt switch. This is the kind of switch that many people associate with being a 'true bypass' switch. Though this switch is used for that, it can also be used for anything that any other type of switch can be used for.

Looking at the picture, here is how the switch works. With the open ends of the lugs facing you (the holes in the lugs facing you), A connects to B. D connects to E. G connects to H. Step on the switch and then B connects to C, E connects to F, and H connects to I. Notice the one constant – the lugs B, E, and H are always on, or 'constant'.

A dpdt spdt and spst works the same basically. On a dpdt, there would only be lugs A, B, C, D, E, and F. On a spdt there would only be lugs A, B, and C. On a spst there would only be lugs A and B.

True Bypass in your existing pedal

By far a common question I get is how to make a Boss, Ibanez, DOD, or other pedal with electronic switching have true bypass. This can actually be a fairly complicated procedure unless you are already familiar with the electronic switching circuits (called 'flip-flop' circuits). In order to make these pedals into true bypass, it requires making the pedal so it is always on, then connecting it to a mechanical switch. Also, it generally requires you to rehouse your pedal into a regular Hammond style box instead of the enclosure – there simply isn't enough room for the switch.

The exact details on how to do this vary from pedal to pedal. The easier way is to use a true bypass box, which allows you to bypass the signal going to the pedal or pedals of your choice. See <http://www.indyguitarist.com/tb-explain.htm> for more information.

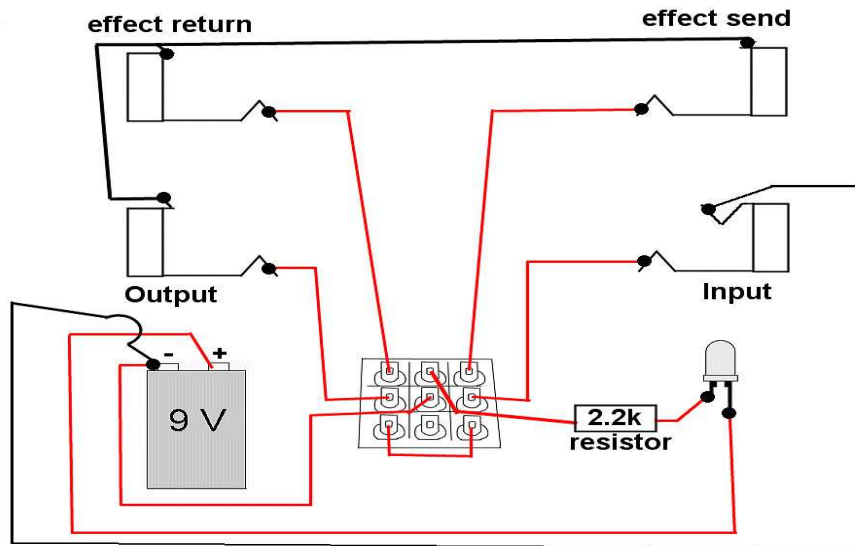

When wiring up your own pedal or jacks, this shows what the individual parts go to. The 'ring' is connected to ground, the 'tip' is carrying the signal.

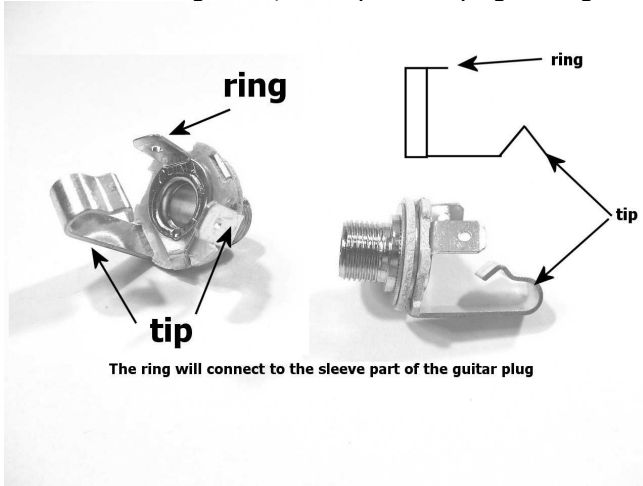

The ring will connect to the sleeve part of the guitar plug

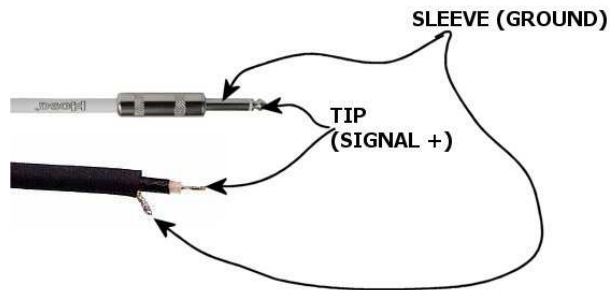

All about Components

Component chart

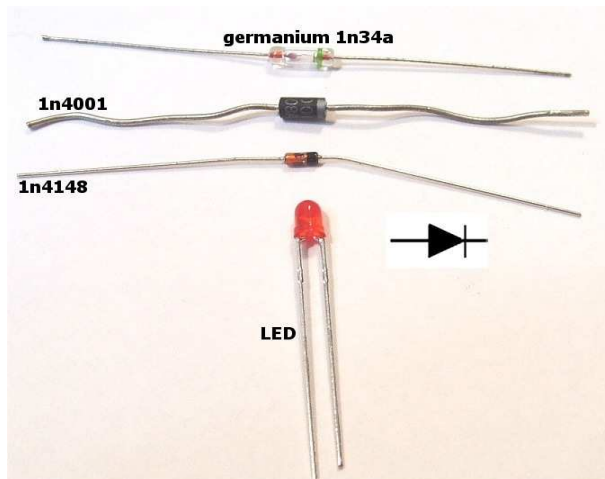

Film Capacitors

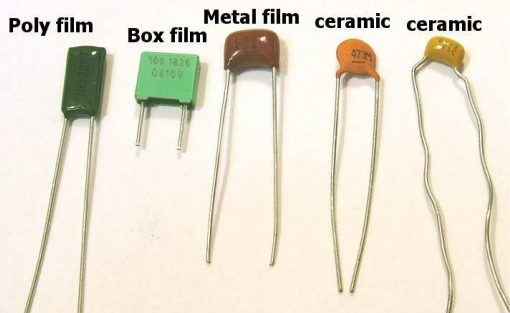

Film caps

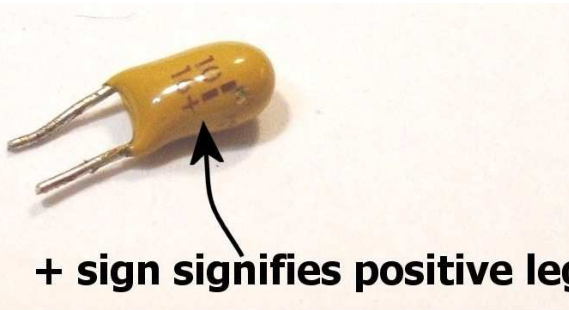

Tantalum cap

NOTE: The positive side is marked on tantalums, where as the negative side is marked on electrolytics. When swapping them out for one another, make sure you orientate them correctly, or you'll risk messing the pedal up.

Polarized capacitors have a negative and a positive to them, and can only be installed in one direction.

Polarized Capacitors

Tantalum



Radial Electrolytic



Axial Electrolytic

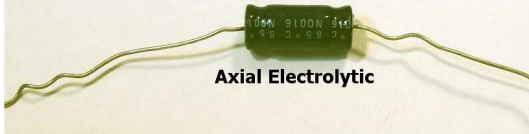



LED'S
 (light emitting diodes) – when used in place of a clipping diode, they may or may not light up, depending on which circuit the pedal is composed of.

Notice there is one leg longer than the other. The longer leg is the positive leg of the led.

Note about picture on left with the lighted Led: If you do this, make sure you use an old battery, not one with full power, or you will burn the led out, and render it useless.



Capacitor Codes

Large capacitors have their values printed on them in plain terms, such as 100 uF (some on the web use 'mf'). We use the letter u as a substitute for the Greek letter micron, so "100 uF" represents 100 micro-farads.

Small capacitors often use a 3-digit code to indicate their value. This code is similar to the resistor color code scheme, except that it uses digits instead of colored stripes. The first two characters are the 1st and 2nd significant digits, and the third digit is a multiplier. Values are expressed in pico-farads.

Examples of some of the more common caps we use:

Writing On Capacitor	Value of Capacitor	
103	.01.uF	If there are only 2 digits printed on a small disc capacitor, this is likely to be the value written directly in picofarads, such as "47" = 47 pF. "470" ALSO = 47pf. Letters are used to indicate tolerances. For example, a cap marked 102J has
223	.022uF	
473	.047uF	
104	.1uF	

224	.22uF	a nominal value of 1000 pF/ .001uF and a +/- 5% tolerance. It can have an actual capacitance as low as 950 or as high as 1050 pF.
474	.47uF	
105	1 uF	
102	.001 uF/1000 pf	
101	100 pf	
100	10 pf	

What type/size of part do I need? What watt/volt/rating?

Another common question I get quite a bit is 'how many volts do the caps/resistors/led's/etc need to be?'

The main difference as far as we are concerned is size. As long as the capacitor is rated 18 volts or more, you will be totally safe with nearly any guitar pedal circuit, and all the pedals that we have mods for. Resistors we use are commonly 1/8 watt and 1/4 watt, mainly due to size.

What is the difference between caps/resistor types?

I generally use film caps whenever possible. Metal film from digikey (part numbers elsewhere in this book and at www.guitartone.net/buyparts.htm) to be exact. They are a better tolerance, I like the sound of them better, and they are a little quieter where noise can be of concern. If you want to be a true audiophile, instead of the smaller ceramic caps try using silver mica caps. I rarely if ever do, though. I don't like the sound of them! I try not to use tantalum caps simply because I don't like the way they sound generally, though there are a few exceptions. Keep in mind...I'm being anal and picky. Don't sweat the type of cap/resistor/etc too much.

Resistors – I use metal film where noise is a main concern, and standard carbon films almost everywhere else. Some like the sound of the carbon composites best though, which are very similar but made out of a different material. They can be hard to find in various values though.

Installing pots and switches

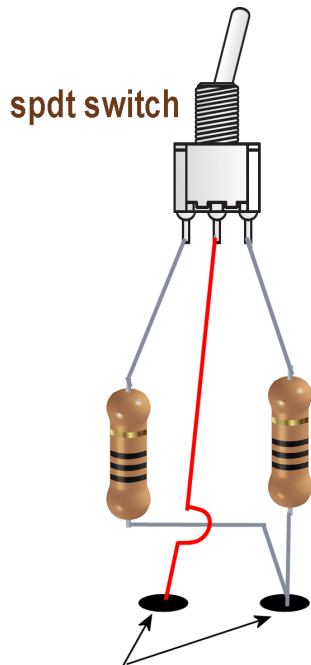

circuit board holes where the resistor would normally connect

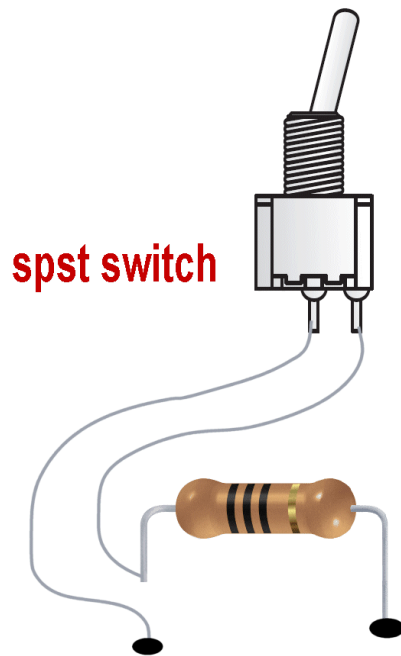

Note that if you are switching capacitors diodes, or another part, substitute that part in place of where you see the resistors in the picture.
When connecting a switch to your pedal, you will hook it up as shown above. The above switch is a spdt, which means 'single pull, double throw'.

The above diagrams are examples – simply substitute the resistors for whatever part you want to change.

Installing a Pot in place of a Resistor

To install a pot (potentiometer) in place of a resistor, wire as shown. If you are replacing a 10k resistor, simply use a 10k potentiometer (or "pot") and connect as shown. The black circles indicate the circuit board holes that the resistor is connected to to begin with. Remove the resistor and wire the pot in as shown. This will give you a 'variable resistance' and you'll be able to tweak to your heart's content.

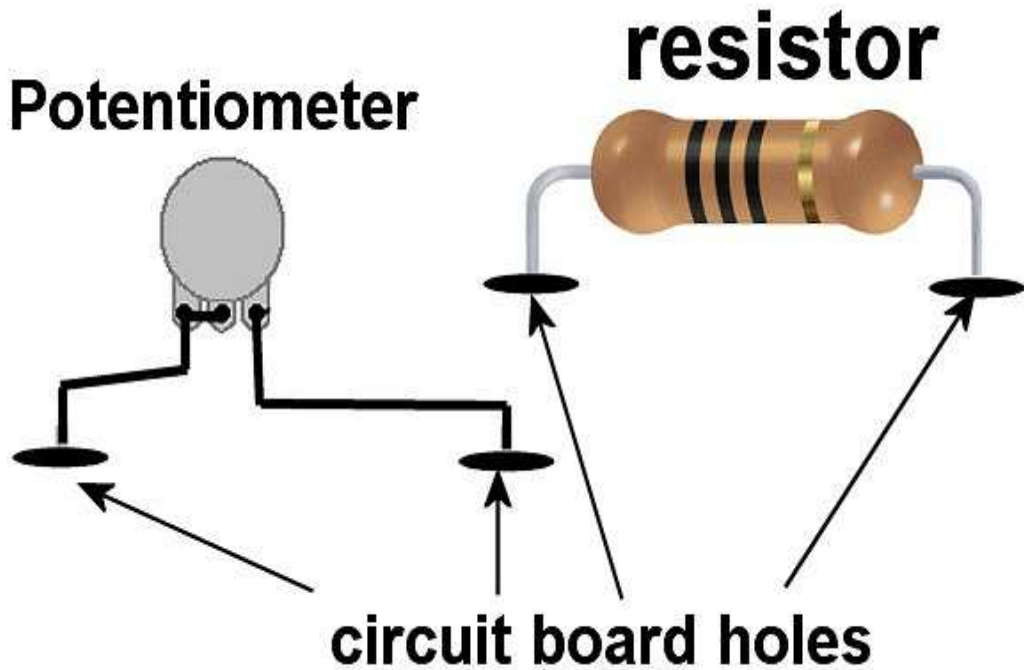

How to use a Multimeter

What do meters measure?

A meter is a measuring instrument. An ammeter measures current, a voltmeter measures the potential difference (voltage) between two points, and an ohmmeter measures resistance. A multimeter combines these functions, and possibly some additional ones as well, into a single instrument.

Before going in to detail about multimeters, it is important for you to have a clear idea of how meters are connected into circuits. Diagrams A and B below show a circuit before and after connecting an ammeter:

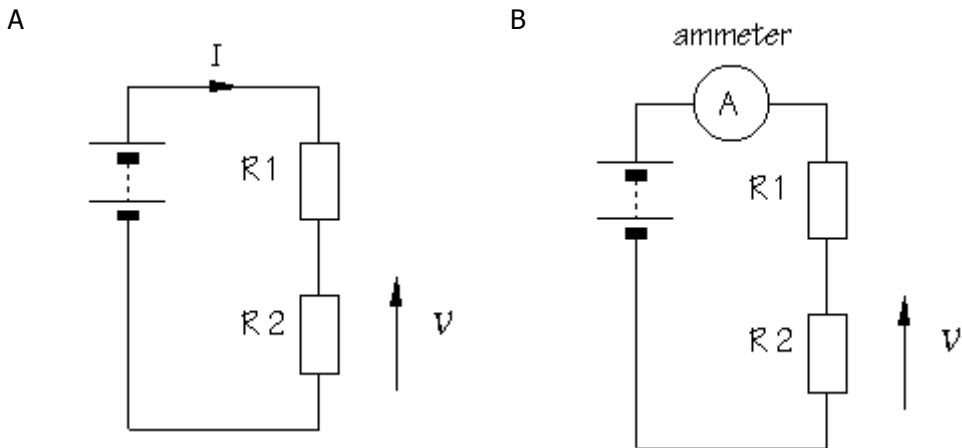

to measure current, the circuit must be broken to allow the ammeter to be connected in series

Think about the changes you would have to make to a practical circuit in order to include the ammeter. To start with, you need to break the circuit so that the ammeter can be connected in series. All the current flowing in the circuit must pass through the ammeter. Diagram C shows the same circuit after connecting a voltmeter:

A

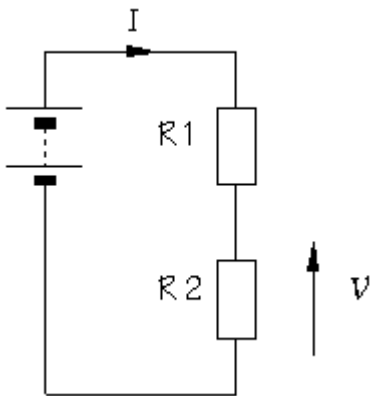

C

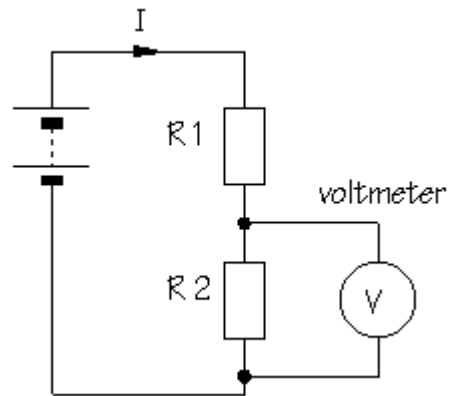

to measure potential difference (voltage), the circuit is not changed:
the voltmeter is connected in parallel

This time, you do not need to break the circuit. The voltmeter is connected in parallel between the two points where the measurement is to be made. Since the voltmeter provides a parallel pathway, it should take as little current as possible. Voltage measurements are used much more often than current measurements.

The processing of electronic signals is usually thought of in voltage terms. It is an added advantage that a voltage measurement is easier to make. The original circuit does not need to be changed. Often, the meter probes are connected simply by touching them to the points of interest.

An ohmmeter does not function with a circuit connected to a power supply. If you want to measure the resistance of a particular component, you must take it out of the circuit altogether and test it separately, as shown in diagram D:

A

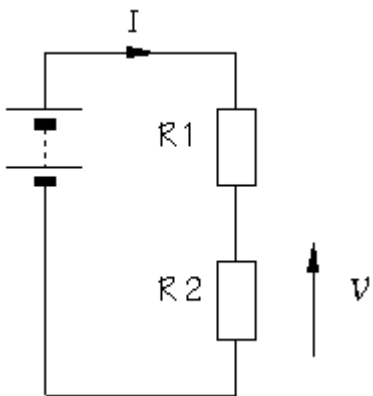

D

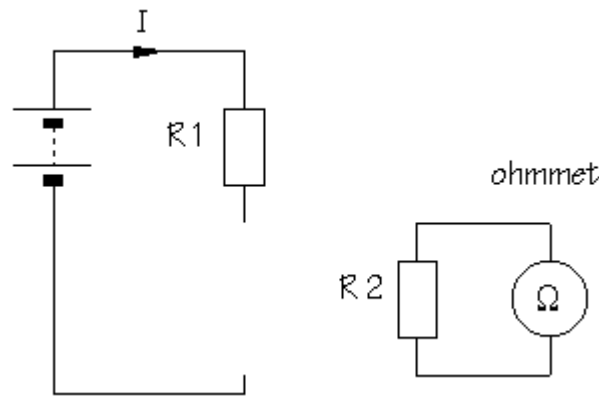

to measure resistance, the component must be removed from the circuit altogether.

Ohmmeters work by passing a small current through the component and measuring the voltage produced. If you try this with the component connected into a circuit with a power supply, the most likely result is that the meter will be damaged. Most multimeters have a fuse to help protect against misuse.

Digital multimeters

Multimeters are designed and mass produced for electronics engineers. Even the simplest and cheapest types may include features which you are not likely to use. Digital meters give an output in numbers, usually on a liquid crystal display.

The diagram below shows a switched range multimeter:

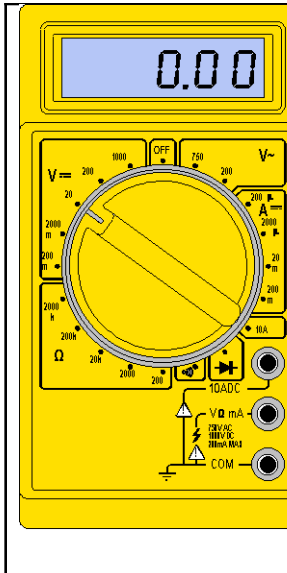

Switched range multimeter

The central knob has lots of positions and you must choose which one is appropriate for the measurement you want to make. If the meter is switched to 20 V DC, for example, then 20 V is the maximum voltage which can be measured, This is sometimes called 20 V fsd, where fsd is short for full scale deflection.

For circuits with power supplies of up to 20 V, which includes all the circuits you are likely to build, the 20 V DC voltage range is the most useful.

DC ranges are indicated by **V=** on the meter. Sometimes, you will want to measure smaller voltages, and in this case, the 2 V or 200 mV ranges are used.

What does DC mean? DC means direct current. In any circuit which operates from a steady voltage source, such as a battery, current flow is always in the same direction. Every project we will talk about uses dc current.

AC means alternating current. In an electric lamp connected to the domestic mains electricity, current flows first one way, then the other. That is, the current reverses, or alternates, in direction.

⚠ MAINS VOLTAGE ⚠

For safety reasons, you must NEVER connect a multimeter to the mains supply.

You are not at all likely to use the AC ranges, indicated by **V~**, on your multimeter.

An alternative style of multimeter is the autoranging multimeter:

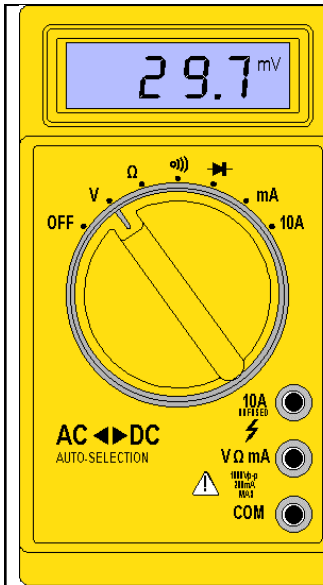

Autoranging multimeter

The central knob has fewer positions and all you need to do is to switch it to the quantity you want to measure.

Once switched to V, the meter automatically adjusts its range to give a meaningful reading, and the display includes the unit of measurement, V or mV. This type of meter is more expensive, but obviously much easier to use.

Where are the two meter probes connected? The black lead is always connected into the socket marked COM, short for COMMON. The red lead is connected into the socket labelled VΩmA. The 10A socket is very rarely used.

Analogue multimeters

An analogue meter moves a needle along a scale. Switched range analogue multimeters are very cheap but are difficult for beginners to read accurately, especially on resistance scales. The meter movement is delicate and dropping the meter is likely to damage it!

Each type of meter has its advantages. Used as a voltmeter, a digital meter is usually better because its resistance is much higher, $1\text{ M}\Omega$ or $10\text{ M}\Omega$, compared to $200\text{ k}\Omega$ for a analogue multimeter on a similar range. On the other hand, it is easier to follow a slowly changing voltage by watching the needle on an analogue display.



How To Desolder



How To Desolder

De-soldering is required when electronic components need to be removed from a circuit.

A proper desoldering technique can soon be acquired with practice – all you need to do is buy some scrap boards to have a go with, and desolder to your heart's content!

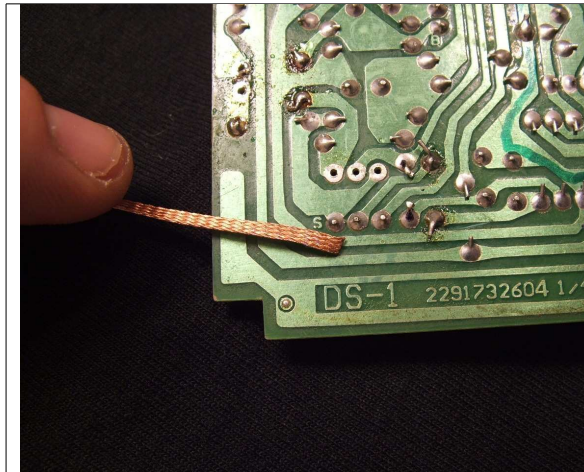

Select a suitable width of braid, and press it down onto the COLD joint using the hot tip of the iron.

(Right) Molten solder is drawn up by capillary action into the braid. Care not to overheat, or 'drag whiskers' of solder over the board, nor let the braid solidify on the joint!

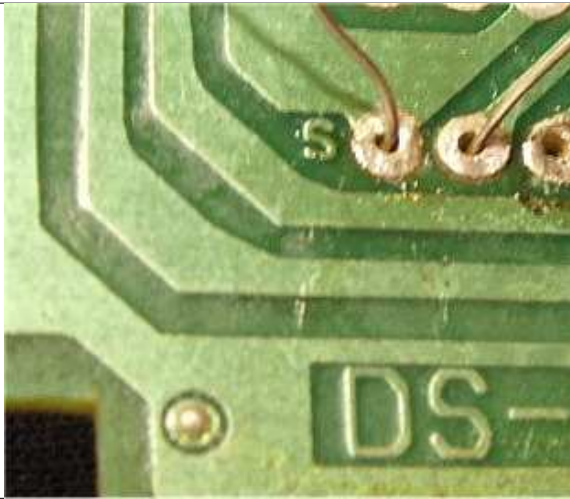
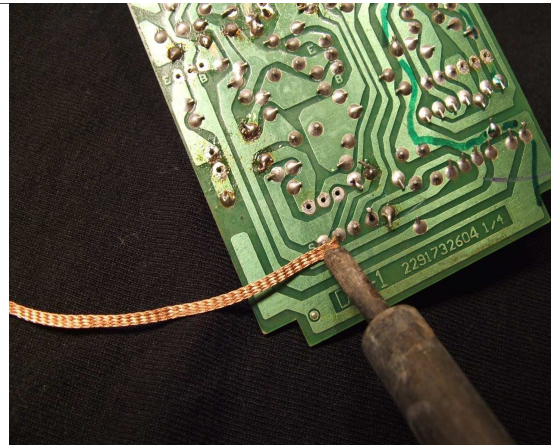

The component may drop out of the board after desoldering. Sometimes, it may need persuading with pliers, however.

Here is a close-up shot of both joints, now desoldered and ready for the replacement part to be fitted.

How To Solder



How To Solder

Soldering is a delicate manual skill that only comes with practice. Bad soldering technique can be a cause of major disappointment which damages your confidence. It needn't be like that: soldering is really easy to learn, and like learning to ride a bike, once mastered is never forgotten!

If you're a beginner, our advice is that it's best to practice your soldering technique using some clean, new parts. Also practice desoldering.

Clean the iron "bit" (tip) using a damp sponge



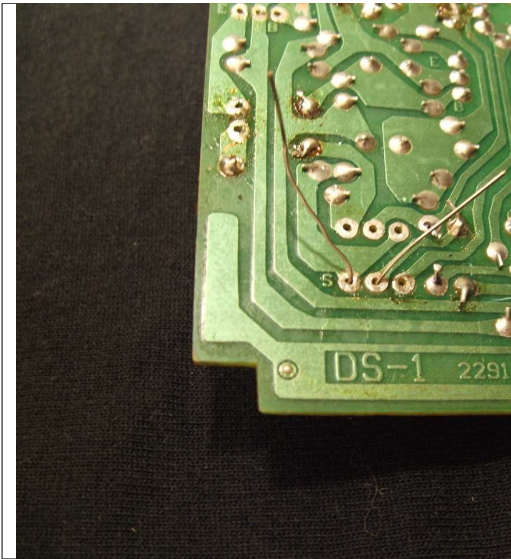

Insert components and spread them apart a little so that the part is held in place.

Apply a clean iron tip to the copper and the lead, in order to heat *both* items at the same time.

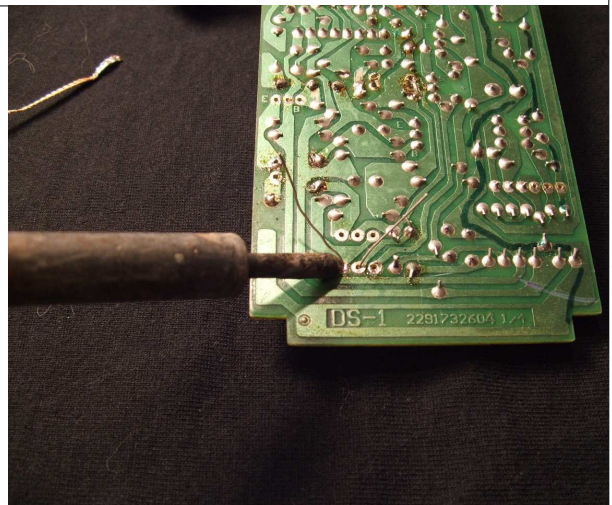

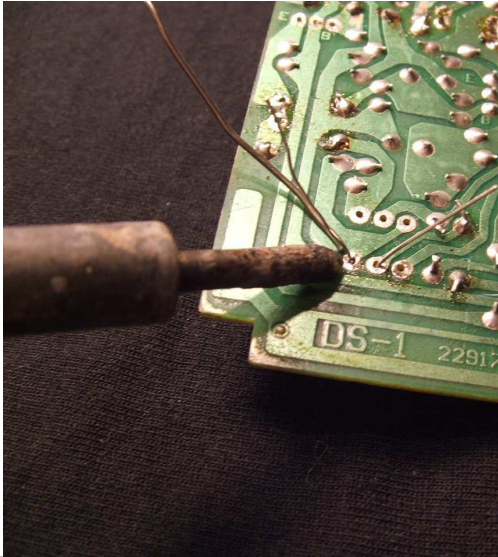

Continue heating and apply a little bit of solder...don't use too much! If you do, you run the risk of soldering two solder pads together that aren't supposed to be joined or soldered together. Remove the iron and allow the solder joint to cool naturally (just takes a second or two)

It only takes a second or two to make the perfect joint, which should be nice and shiny.





An example of a "dry" joint – the solder failed to flow, and instead beaded to form globs of solder around the wire.

An example of a "bridged" joint – the solder spilled over to the solder joint next to it, touching somewhere it is not supposed to. Avoid this! This is a common reason for a pedal not working after a modification.

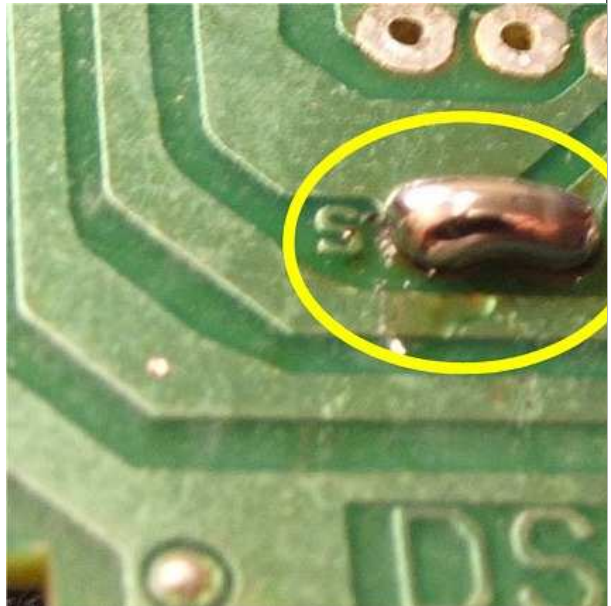

How to repair a broken solder tab on an effect pedal

-Notice the image below. The broken/missing solder tab is shown, as well as the 2 locations connected to this solder tab, shown as point a, and point b.

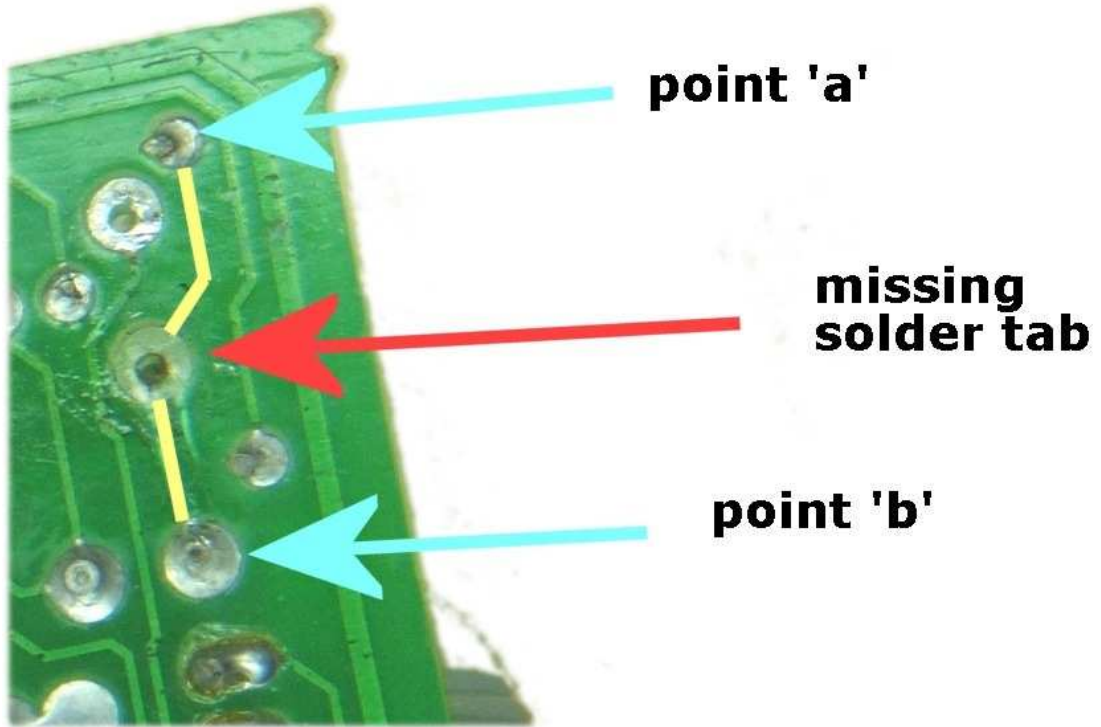

-You will either be soldering on the solder traces (shown outlined in yellow here), or you can connect it directly to your pedals' "point a, and point b".

We will need to scratch off a small amount of the protective coating that covers the solder trace. This will allow the solder to bond with the solder trace.

-The yellow circles here show where you need to scratch off the protective coating.

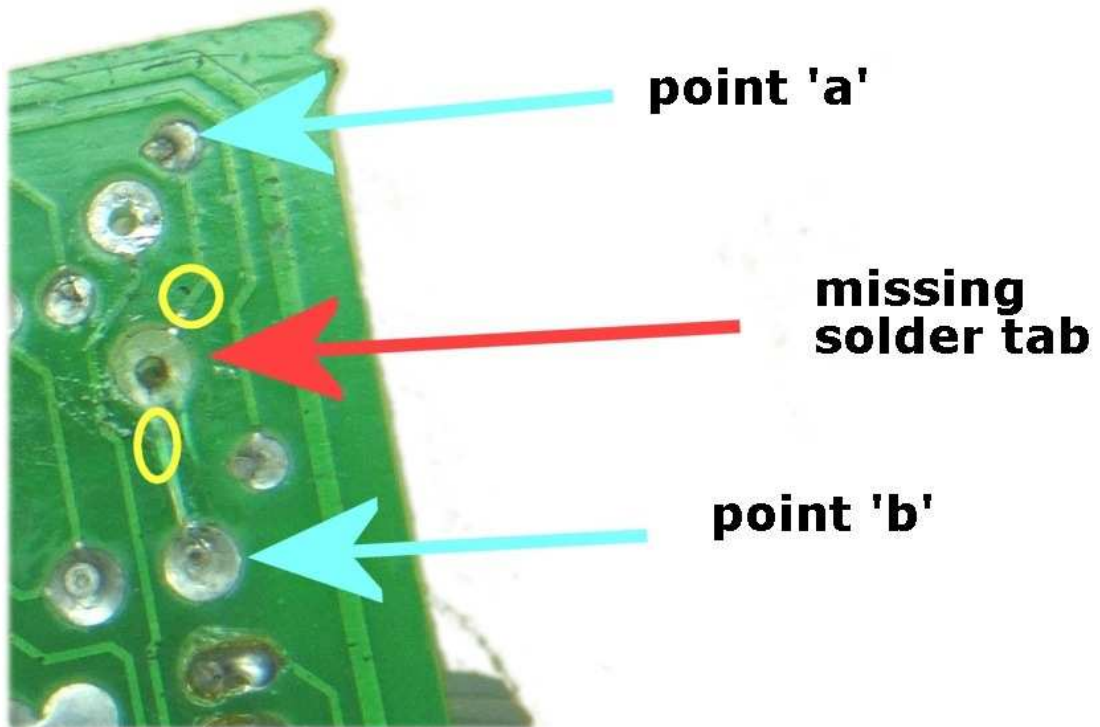

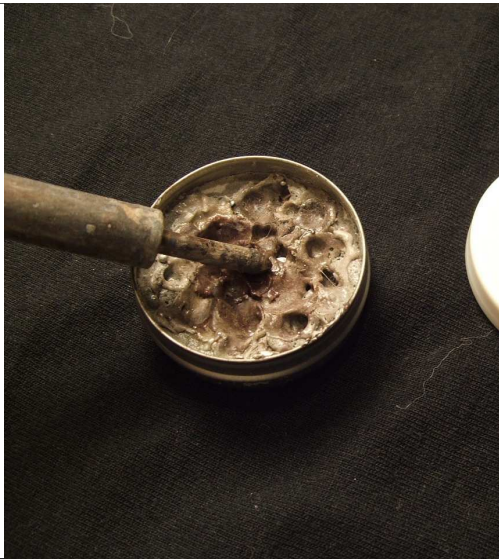

When finished soldering for the day, make sure you dip your iron into a small container of "tip tinner and cleaner" (64-020d at radio shack), or glob a bit of solder on the end of your iron and turn the iron off, letting it sit with the solder on it to protect the tip.

-insert your new part, keeping the component leg extra long until after it is soldered. Solder a scrap piece of wire, or old component leg to connect the traces.

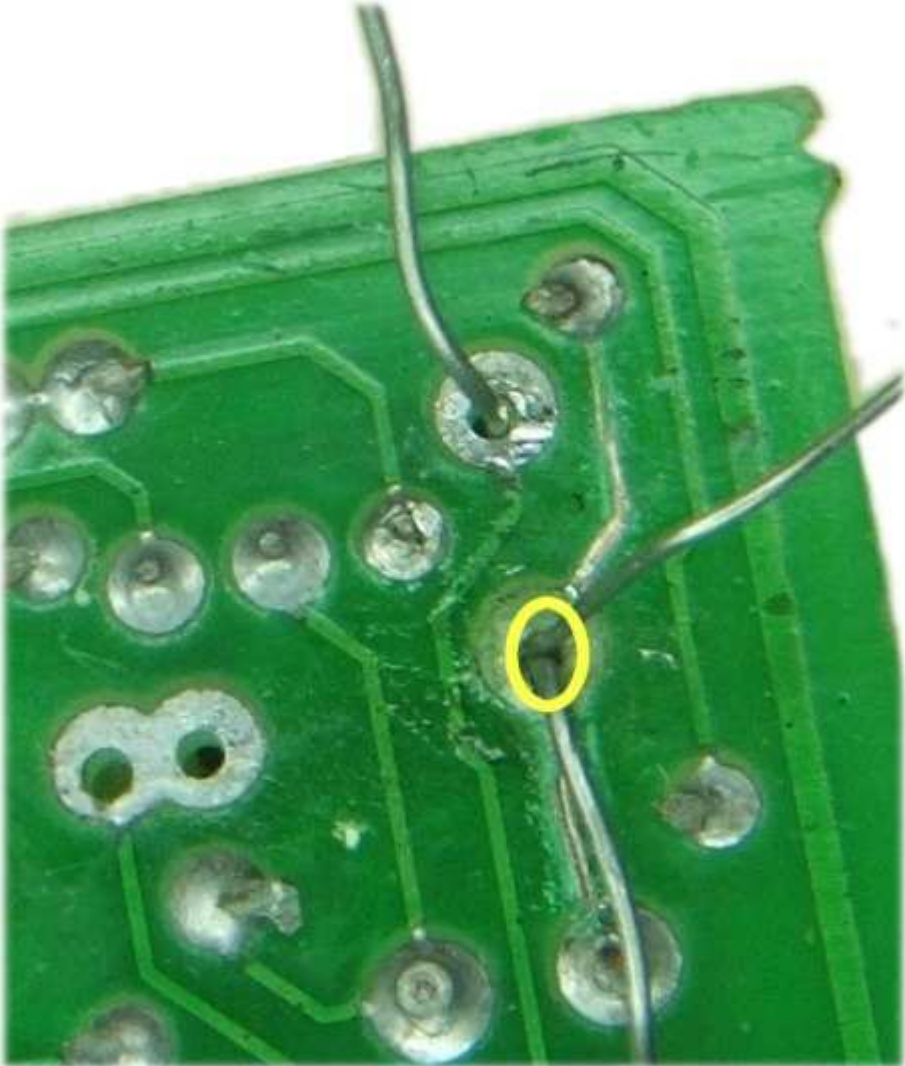

-This shows what it looks like after you solder the component leg onto the trace. Make sure your solder doesn't touch anything else (other solder tabs, or other traces).

-Notice the solder trace going to location 'a' that has already been scraped down to the bare copper.

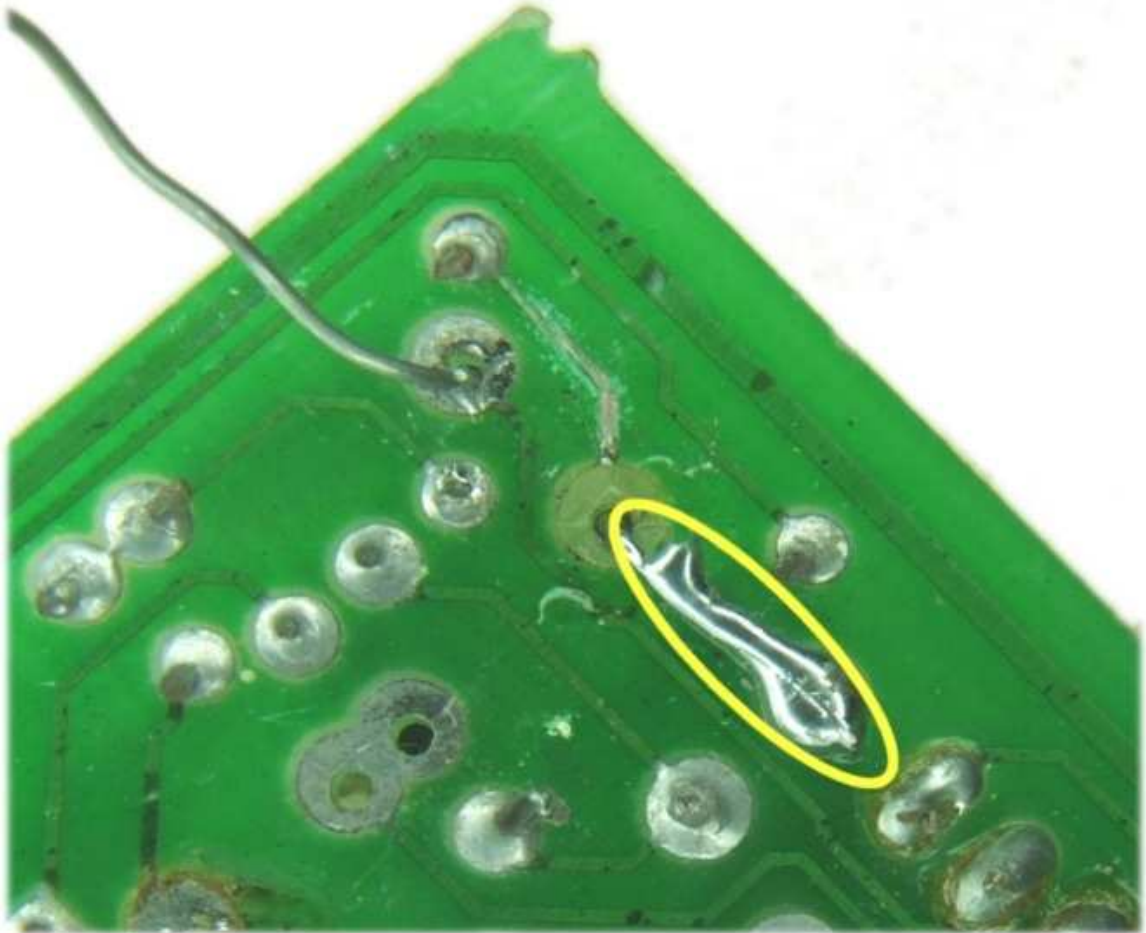

-This is after the extra leg was soldered to the component leg, which connects the two traces on each side of the solder tab.

This is actually one long piece of solder, though the shadows make it look like it is 2 separate pieces.

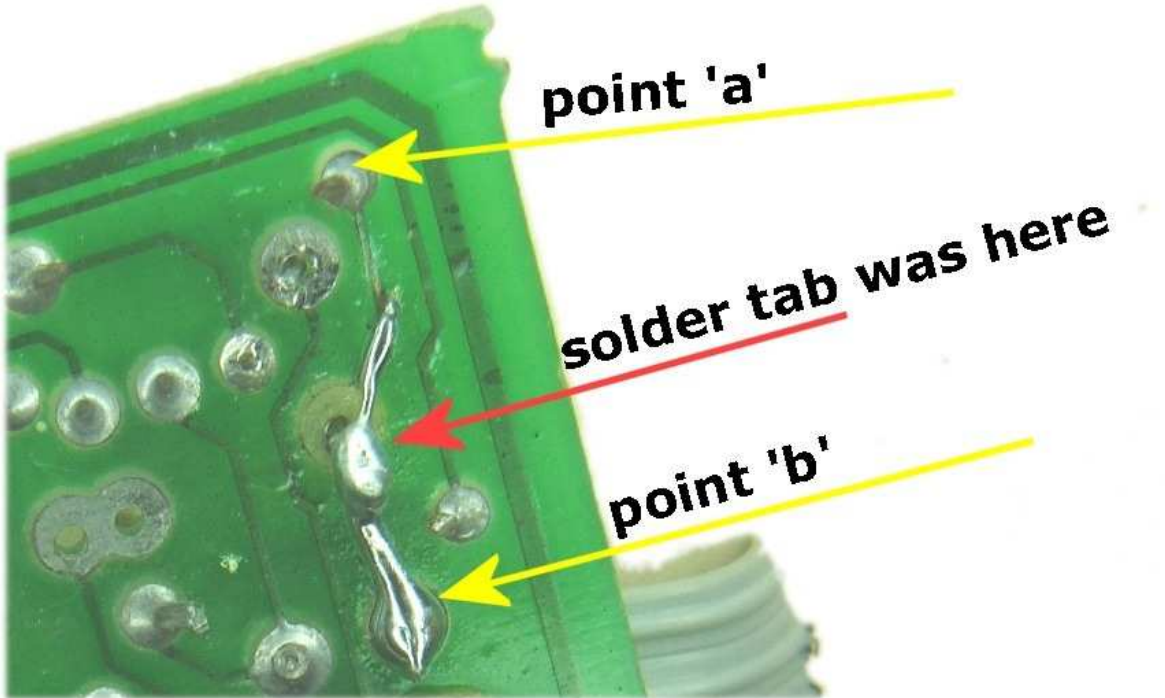

That's it, your finished!!

Troubleshooting



- * Check all connections that go to ground or power.
- * Check all of your connections, especially making sure that everything is supposed to go to ground does indeed to go ground.
- * Using the resistor measuring function (or ohmmeter) on your multimeter, you can check for continuity where all the components should be connected to ground.
- * Make sure that all points that are supposed to receive power really are getting power by looking at the connections and by measuring with a voltmeter. Connect the black lead of the voltmeter to ground of your circuit and touch the connection with the red lead of the voltmeter.
- * If you have changed a transistor or IC, double-check the orientation of the transistor or IC, make sure that the transistor or IC has the right pins in the right places.
- * Check the orientation of your electrolytic capacitors if you used used them
- * Check your resistor values throughout your circuit. It is easy to accidentally use a 470k resistor instead of a 4.7k (for example) and this could easily make a circuit not work correctly or at all. With the circuit going, measure the voltage at the battery terminal and make sure there is ~9 volts. If there are zero volts, it's possible you have a short in the circuit.
- * Very gently twist the circuit board and/or move the wiring connected to it to see if you have bad solder connections. Sometimes the circuit will spring to life because of a bad solder joint and this can help to show if you do or not.
- * If you are testing the board in the enclosure and it worked while it was out of the box, look for any place the enclosure or a pot or stray wire might be touching the board or a wire and grounding out the circuit.
- * If you are still having problems at this point, make an Audio Probe (see below) and trace through the circuit.

Using an Audio Probe

Using a standard guitar cord, cut off one of the 1/4" connectors. Put a .1uF non polarized capacitor on the hot lead, put the shield/ground to the ground of your circuit. Then, simply plug the other end into an amp and turn the volume low. Once this is done, you can use the tip of the capacitor to probe around the circuit. You can hear how the circuit works by touching different places in the circuit. Start from the input of your stompbox and work your way through the circuit. Follow the signal path to see where your problem lies.

You can plug your guitar into the circuit and have someone else strum it while you probe OR you can use some sort of a signal generator (such as a keyboard, radio, etc) to send signal into the circuit. You can hear the effect change the tone of the input signal.

This simple technique can alert you to cold solder joints, if you hear audio before a joint, then none right after, it's probably a cold solder joint. You can hear how a transistor is amplifying the audio. There is a lot you can learn by probing around the circuit!

** Special thanks to Aron of www.diystompboxes.com and www.diypedals.com for help with this trouble shooting guide!

How to build an audio probe:

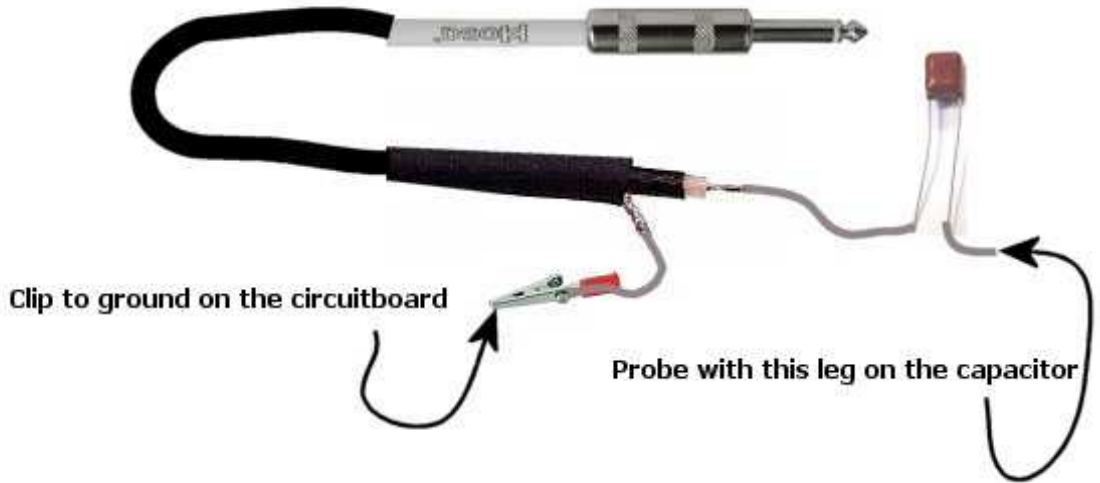

How To Modify Guitar Pedals



For this demonstration, I'll use the sd-1...but by following the directions in this book, you'll be able to modify nearly any pedal!

The first thing you'll need to do is unscrew the four screws on the bottom of the pedal.

Put the screws, the clear plastic and the bottom plate into a small tray or bowl of some sort so you can avoid losing any parts.

For other odd shaped pedals (such as the visual sound), please use this guide with the specific guide for those pedals (included).

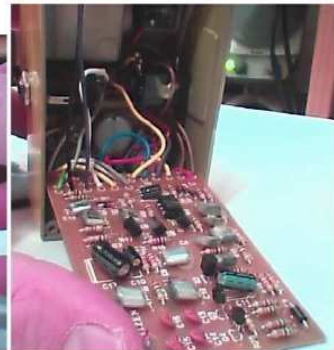
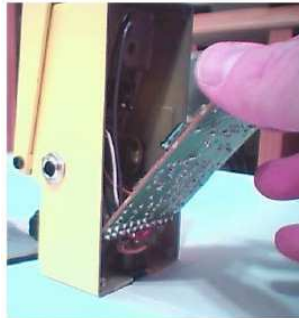

Lift up gently on the circuit board. This is what the inside of the sd-1 will look like.



When working with guitar pedals, or any other electronic equipment, it's advisable to 'discharge the capacitors', which means you are bleeding off any stored electricity inside the pedal.

Simply use a screwdriver with a rubber/plastic handle, and touch the solder pads and the pedal case at the same time. Nothing will happen visually that you can see, but if this were a higher voltage piece of equipment like a guitar amp, you would see a huge spark and hear a loud POP!

All you are doing here is running a little bitty tiny bit of electricity to ground (which on a pedal, is ultimately the case).

DO NOT USE THE SOLDERING IRON TO DO THIS—you will end up messing up the solder joints.

Let's take a look at how these DIY kits are put together in this book using the DIY forms. Here is a sample DIY form for the Boss SD-1. We have three columns, and sometimes there will be a fourth column. There will be columns for "Location of circuit board part", "mod value" which tells you what you are installing in this "location", and if applicable "what it affects". Sometimes there will be a "stock value" as well – this is simply telling you what the stock part was, though in the newer DIY forms I don't list that usually.

Also, notice that there isn't always something under "what it affects". This is because not EVERY change is going to yield a huge change – sometimes 4 or 5 changes together will give you a specific change but individually the change is subtle.

Sd-1 cuervo mod

Location	Mod value	What it effects
c2	.047 uf	
c3	.047 uf , for more bass, use .15 uf	.047 .15
c10	1 uf	
c6	remove	
d6	1n4001	
d4	1n4003	
Blue on/off led		

Carefully look over your modification details – locate the first change to be made. You can actually start wherever you want, but its generally good habit to start from the top.



TIP: On any circuit board, you will see letters and numbers generally (which will be referenced on the mod details.)

If you aren't sure what kind of part it is, here's a tip:

D= DIODE

C= CAPACITOR

R= RESISTOR

IC = IC CHIP (ALSO CALLED OP-AMP)

Q= TRANSISTOR

Locate the part numbers on the pedal's circuit board and the modification details. Begin marking the solder joints with a black felt tip marker (ANY color will do actually!)



When done marking the solder pads, it will look something like this (of course, depending on the specific changes YOUR pedal requires!)

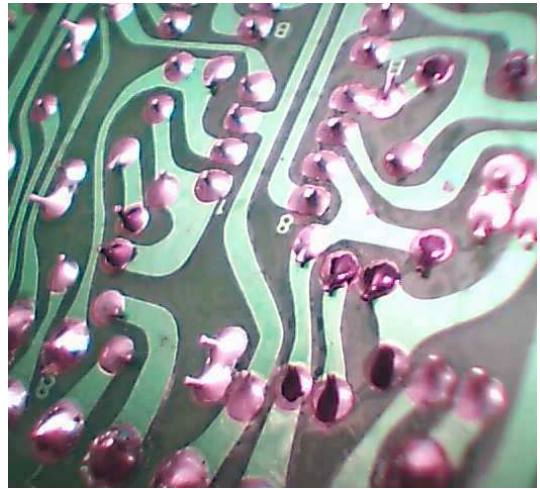

TIP: If you mark the wrong capacitor, don't worry about it – you can leave it alone, or what I sometimes do is reheat the solder joint just slightly, which will remove the marker. Leaving it won't hurt anything, it just might confuse you if you have a lot of markings on your pedal!



To remove the current component that will be replaced, you will need your de-soldering braid and solder iron.

Place the face of your de-soldering braid on the solder pad on the circuit board. Apply your hot solder iron to it, for just a few seconds –if it doesn't soak it all up, pull the iron away, wait about 3 seconds, and try it again with a clean/new piece of desolder braid. You will see the soldering braid 'suck up' the solder.

Now, Change the first component on the list. Then, of course, cut the legs off after you solder it (like you do after each component is installed).

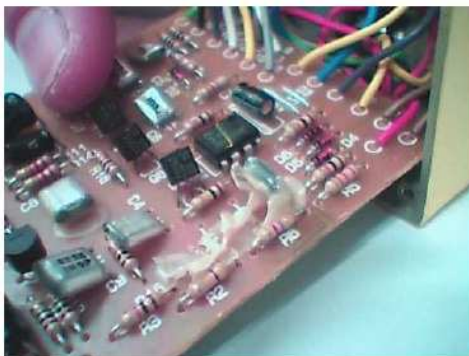

NOTE: On some boss pedals, you will see a bit of yellow epoxy – be careful and use a needle nose pliers to remove whatever you need to remove to get the part in!

Now, the most important time saver: **TEST THE PEDAL AFTER EACH CHANGE!!**

Let me say that again: **TEST THE PEDAL AFTER EACH CHANGE!!**

Why test the pedal? That way, if you DID mess up, you know that it has something to do with that last part you installed. If you contact me about a problem, be prepared: the first question I'll ask is "Did you test the pedal after each change?" If you say no, I can't be of much help to you!

No need to put the back cover on, just plug it into your guitar and amp and make sure everything is going as it should.

If you don't hear any sound, or it makes a funny sound, then you know something is not right. ~First jiggle the pedal a little bit to make sure nothing is grounding out against the case (since the cover and circuit board is now loose).

~If that doesn't fix it, make sure the orientation of part is correct (as in electrolytic caps, tantalum caps, diodes, and leds – see 'chart' included with this kit).

~Double-check the solder joints to make sure they are done properly—use of a magnifying glass makes it a ton easier!

~Make sure that the component you installed doesn't have its legs touching any other component's legs or against the case or anything that might cause it to ground out.

~If you're still having problems, simply remove the part and try it again.

99.9% of the time it is an incorrectly soldered joint. If this doesn't solve the problem, see the 'troubleshooting' chapter elsewhere in this book.



Continue replacing parts on the circuit board, by going down the list. Check the pedal after each component is installed.



Resistors and capacitors (except electrolytic and tantalum capacitors) do not need to be orientated any certain way, there is no positive or negative side of them.

When replacing electrolytic and tantalum capacitors, diodes, LED's (LED's are a type of diode that gives off light when voltage is applied to it), all need to be orientated correctly.

See the Component chart (elsewhere in this book) to get a better understanding of how to know if a component will need orientated or not.

When changing diodes, make ABSOLUTELY sure you put them in correctly! If you don't, the pedal will not work when on. Here is how you would orientate them in relation to the circuitboard diagram and/or schematic:

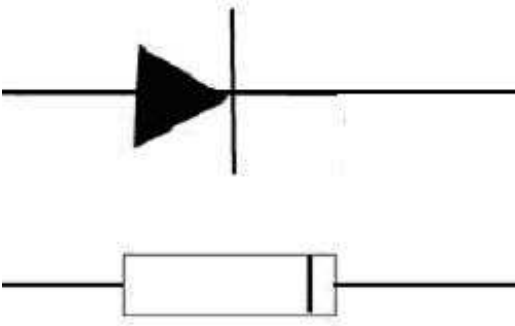
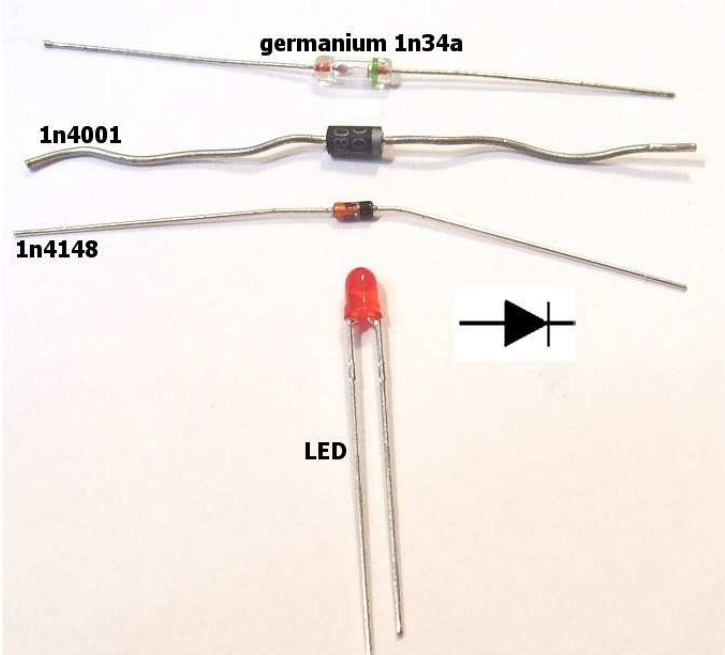

Symbols for Diodes (note orientation on the circuit board, you'll need to orientate the new diode you replace the same direction.)

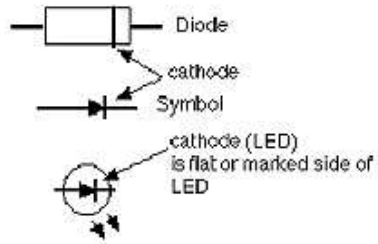

Some mods call for transistors to be used in place of diodes. This is because in some circuits, the transistors sound better. They also have a built in diode, and a little bit of capacitance and/or resistance, which gives them a unique tone, which is pleasing to the ear.

MPF-102 TRANSISTOR USED AS DIODE

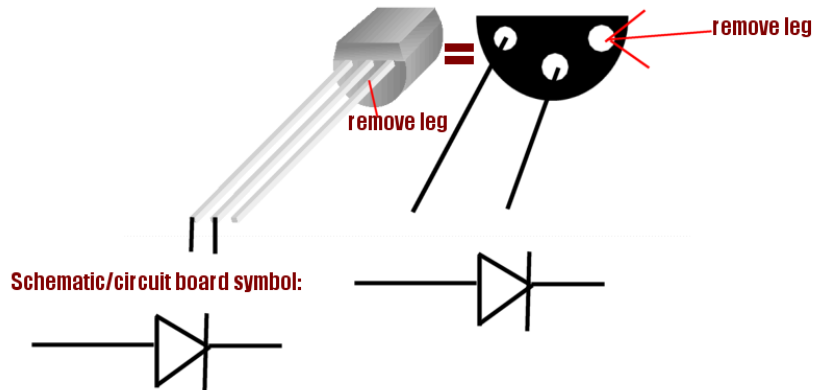

Another way of connecting the mpf102:

MPF-102 TRANSISTOR USED AS DIODE

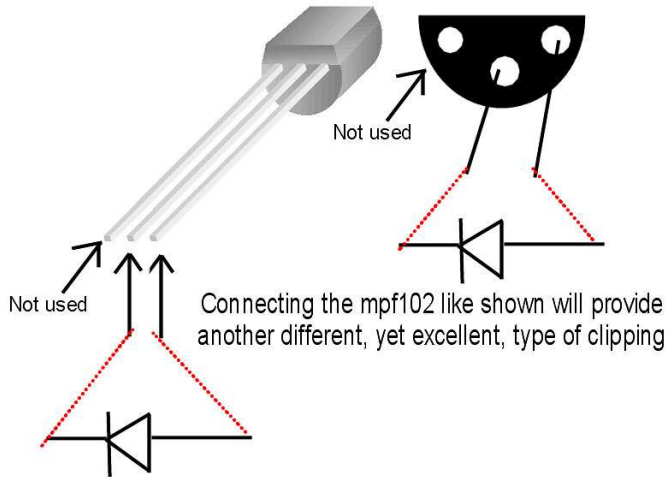

BS170

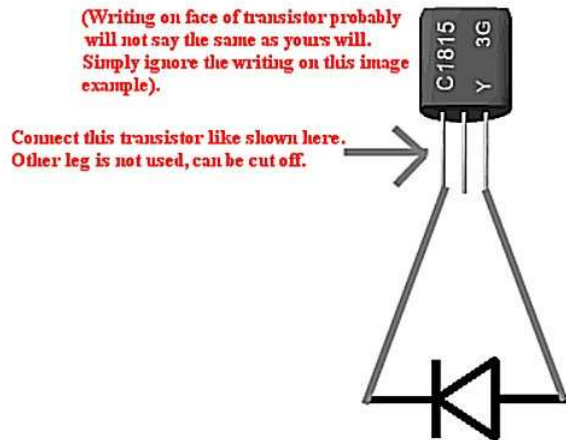

Lastly, you might want to change the LED on/off indicator. Unscrew the screw and pull out the mini circuit board gently with your needle nose pliers.

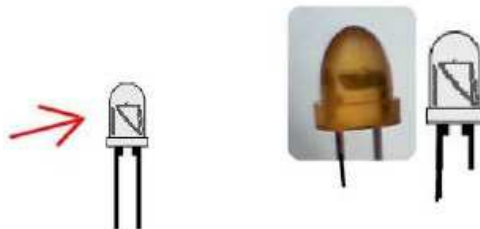

Make sure you mark the orientation of the led. I always mark the side that has the longest leg which will be the straight side of the element (see pic above, arrow is pointing to it), but you can mark either side. Just remember: whichever way the stock led is orientated, the new led must be orientated the same way. If it's not, the led simply won't work. If in doubt, touch your new LED

on their solder pads, with the pedal plugged in, and on. If it lights up, your good, If it doesn't, turn the led around.

If you use a 3mm led like I do, you won't have to drill the case, if you use a 5 mm led, you will have to drill. First find a drill bit that is just barely larger than the led.

Drill VERY carefully, and slowly. You don't want to go fast and go through quickly and risk hitting something inside. Blow the metal debris out (a can of compressed air helps, but not absolutely necessary).

Test everything once again before you put the cover back on.
You're Done! Plug it in and play!

General mods for nearly any pedal

Increasing gain using diodes

With distortion, overdrive and fuzz pedals that use diodes for clipping, you can increase the output level of the circuit with the expense of a little distortion by putting two diodes where there were one or changing the diodes to LED's instead of the stock 1n4148 types.

Diode Configurations

Standard Symmetrical clipping is common in most overdrives and distortions, some fuzzes. This diagram is what a typical clipping diodes section will look like. Notice that though they are in parallel, they are both pointing opposite directions.

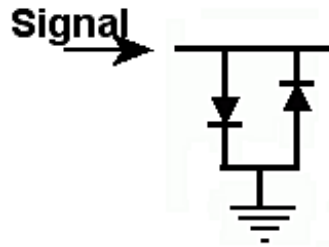

Add a diode in series with both diodes to increase headroom, make louder while still keeping it symmetrical.

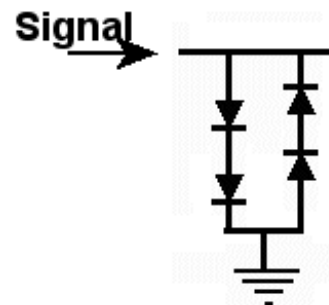

Substitute stock diodes with any size/color/type of LED to increase headroom, make louder while still keeping it symmetrical.

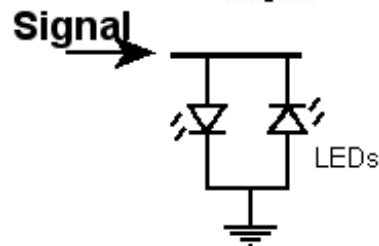

Asymmetrical clipping is often used to make the clipping more responsive and dynamic. It more closely resembles how tube amps clip the signal. There are a number of different combinations a person can use. This diagram shows a 1n4148 or 1n4001 used with a LED.

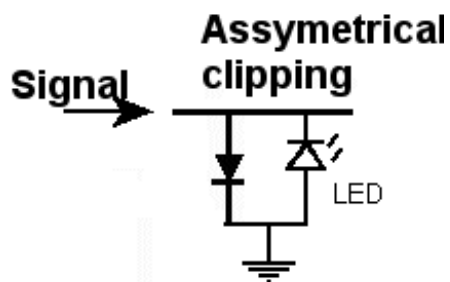

Still another way for Asymmetrical clipping is using two diodes one direction, and only one diode the other direction.

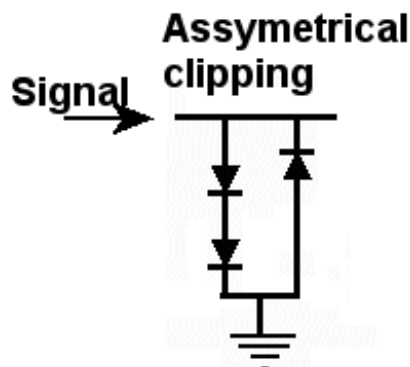

Making the clipping smoother using a capacitor around diodes (cont'd on next page)

You can put a capacitor in parallel around the 2 diode pair and mellow out the high end of the distortion. Increasing the capacitor value will cut out more and more of the highs.

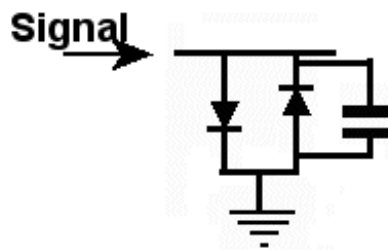

Changing the capacitor value will change the amount of highs get cut from the clipping. Start with 100pf and use a larger size if needed. Other possible sizes: 200pf, 500pf, 750pf, .001uf, .0022uf, and so on. On the blues driver mods, I sometimes use a .0047uf to tame the brittleness and it works wonderfully.

Change the capacitor material type

You can also change the electrolytic and ceramic capacitors to any type of film capacitor. Some people think this makes a huge difference in tone while others can tell little difference.

Electrolytic caps have a looser tolerance (+/- 20%), so a 1uf cap can actually measure a .8uf or a 1.2uf and still be considered a 1uf. Changing to a higher quality film cap will allow you to use parts with closer tolerances, sometimes as close as +/- 5% or even 1%! I think this is where most folks hear the difference, mainly when the cap is in the signal path. With that said, as your ears improve you will start to notice that different types of components sound and "feel" different from each other.

Change the diode type

Change the clipping diodes to different types and combinations (in series) to get different "shades" of distortion. For example, Germanium diodes will be compressed and smooth-fuzzy type clipping. Silicon (1n4148, 1n4001, 1n914, etc) tend to be more crisp, tight, and focused sounding. Fets, transistors and mosfets used in place of a diode (see boss sd-1 mods for example) tends to add a little warmth as well as a nice squishy compressed clipping. Leds sound warmer as well, offer a great crunch, and usually will make the pedal sound louder (as explained a few pages back).

Add a lowpass or highpass filter to change the tonality.

If you have a distortion, overdrive, or other effect that doesn't have a tone control, here is an easy way to add one. This is called a "lowpass filter". The signal goes into lug 3 of the volume pot, lug 1 of the volume pot connects to ground, lug 2 goes both to the tone control AND to the output, which is where the volume should still be connected to. What you are doing is simply adding a wire from lug 2 of the volume pot into lugs 2 and 3 (or just lug 2, it doesn't make a difference here), lug 1 of the tone control pot connects to a capacitor, which then connects to ground. You can also use a mini-trim pot and keep this control inside the pedal. This mod works GREAT on MXR Distortion Plus's, and DOD OD250 overdrives!

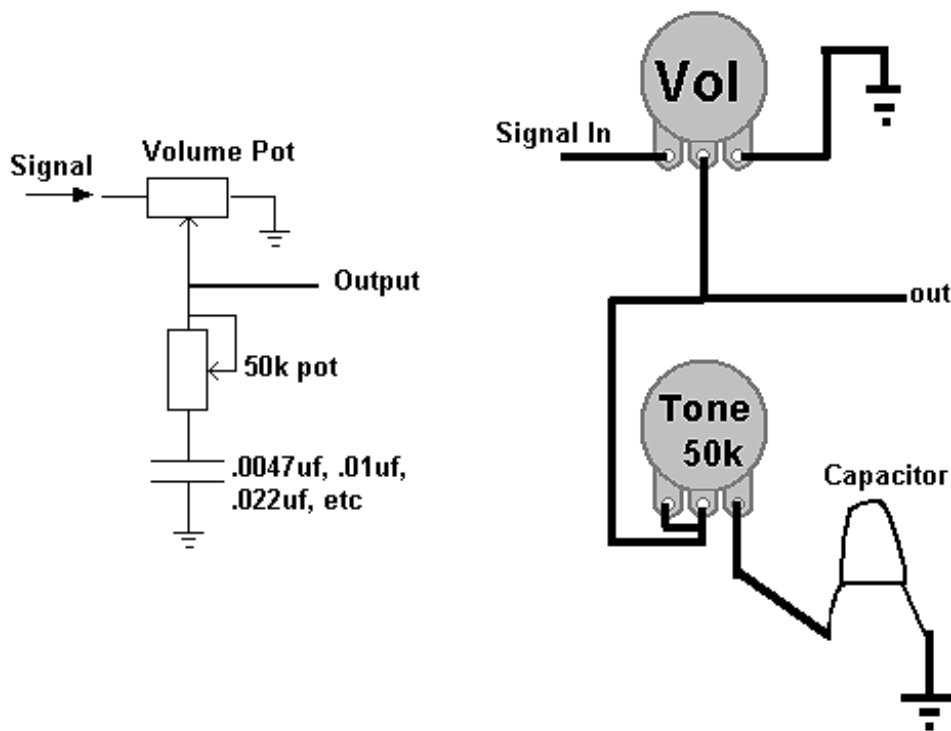

Should you use audio taper or linear taper pots?

You can use either one at any time. The taper may not be as optimum on some applications. Generally, you want to use audio for volume controls and sometimes drive, use linear for everything else. That being said, you can use linear for everything. The both do the same job, the difference is the rate at which the resistance changes as you turn the knob.

If you are using an audio taper pot and notice that it sounds as if the pot is very sensitive either at the end or beginning of the turn of the pot, that is a good indication to use a linear taper.

What kind of wire should you use in your pedals?

In general any type of hookup wire will work - from size 22 gauge and smaller. (The larger the number, the smaller the wire - so 26 gauge is skinnier than 22). I like the "pre-bonded hookup wire" from Small Bear Electronics.

(<http://www.SmallBearElec.com>)

It's a cross between stranded and solid core - very nice. In general solid core will stay where you want, but will not like being moved and can break easily. Stranded is much tougher but resists bends and will generally not look as "neat" in an enclosure. If the circuit is being mounted in an enclosure and will not be removed- solid core is ok.

Connecting a Potentiometer in place of where a resistor once was.

Note that this picture just shows you how to hook the mini-pot up – you will need to remove the resistor and connect wires to the legs of the mini-pot. Note that the resistor is shown only so you understand what to hook the pot up to. You are actually going to remove the resistor and replace with wires connected to your pot.

(see next page)

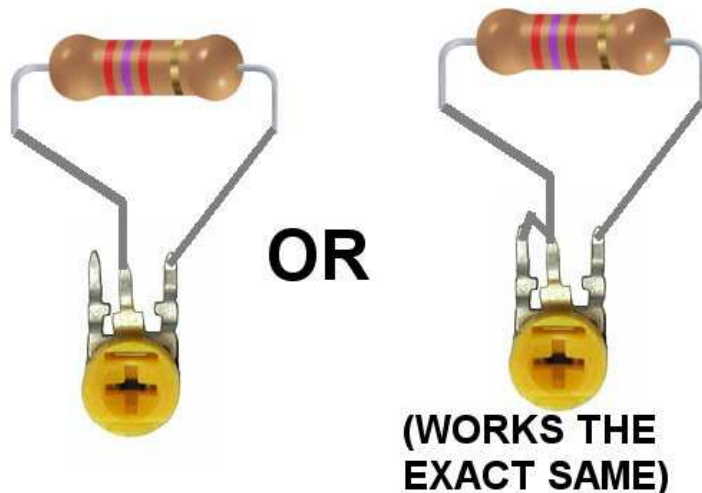

If you want an external potentiometer to instead of an internal mini-pot, here is how it would be connected. Note that the resistor is shown only so you understand what to hook the pot up to. You are actually going to remove the resistor and replace with wires connected to your pot.



OR



(WORKS THE EXACT SAME)

Many overdrive pedals are a variant of a tubescreamer, and most distortion pedals are a variant of a MXR Distortion Plus. Even between these they can be mixed and be somewhat similar. To start, let's look at a schematic of the Tubescreamer, courtesy of General Guitar Gadgets.com.

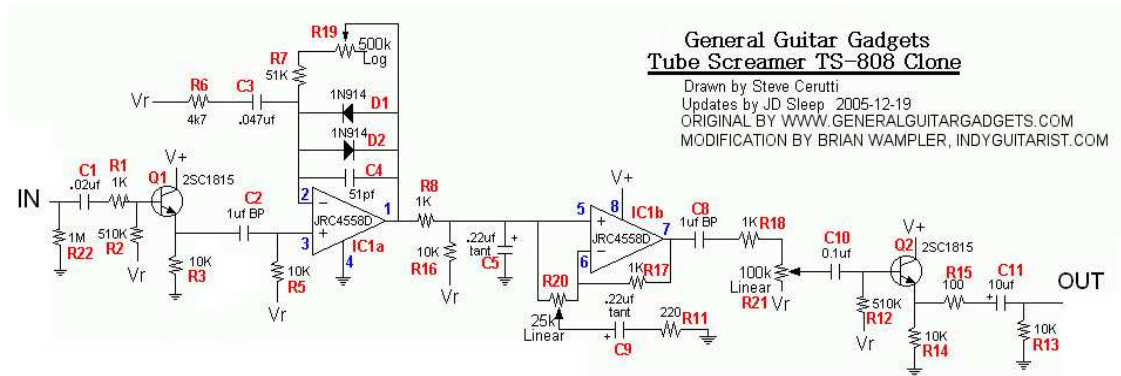

R6/C4: RC network, controls gain, eq along with r19 and c7. For example, for more bass, make c3 larger. This creates a frequency range that gets boosted and then distorted. For example, a stock tubescreamer will have the frequency set at 720.8hz, which is very midrangey. We can lower that frequency. Here are a few examples:

Key: R6 (resistor), C3 (capacitor): frequency center

- 4.7k, .1uF: 338.8hz
- 4.7k, .15uF: 225.9hz
- 4.7k, .22uF: 154hz

To keep the same frequency response but add more gain to the circuit, will double the capacitor value, and divide in half the resistor value basically.

- 2.2k, .1uF: 723.8hz
- 2.2k, .22uF: 329hz
- 2.2k, .47uF: 154hz

Here is a great page to find the frequency for your needs: www.muzique.com/schem/filter.htm

R7 is lowered to provide a cleaner tone with the gain knob is turned down, and r19 (which on the tubescreamer is a pot) can be increased to provide more gain. D1 and D2 are the clipping diodes of course. C4 is a filter, which filters the highs and helps control oscillations (whistling feedback sound)

The MXR Distortion Plus schematic works similar except that the gain pot would be what is R6 in the above schematic, and R19 is a regular resistor. This, however, makes the sound a bit 'muddy' when the gain knob is turned low, since it is changing the frequency of the clipping.

R22 keeps the switch from making a 'pop' sound every time you step on it. The signal goes through C1, R1 and then goes into a transistor which is acting as a buffer - making the signal a low impedance type of signal. The signal leaves this transistor and goes through C2 before going into the opamp which is the first gain stage. R5 here is setting a 'bias' for the opamp which simply is needed to make it work properly. If we didn't have the input buffer we would make this resistor a larger value, 100k or larger.

Signal flow for the Tubescreamer

The signal is boosted and clipped between pins 1 and 2 here, D1 and D2 are diodes that 'soft clip' the signal. C4 helps to keep the noise down. The 500k gain pot works with R6 and C3 in order to set the gain. C3 and R6 together form a calculation that will determine what frequencies mainly will get boosted and clipped. With a 4.7k and .047uf as shown, that frequency is 723 hz. You can change this by changing either C3 or R6 or both. The smaller the resistor, the more gain you will have up to a certain point. If it is too small, you will get oscillations (high pitched whining sounds).

The signal leaves pin 1 and goes through R8 before passing R16 (setting bias for the next stage) and passing C5 which forms a "low pass" filter - it shaves off the highs above 723 hz.

The signal then forms a low pass with the tone control (frequency depends on where the tone control is set) while going into pin 5. This stage not only shaves off more high end (via the low pass filter that the tone pot forms) but also boosts highs as well. The signal then leaves and goes through C8 and R18 before connecting to the Volume control.

The signal then goes out of the volume control, through C10, past R12 (r12 and r2 both set bias for the buffer stages) and then into the 'output buffer'. The signal leaves this buffer and goes through R15 and C11 before going to the output.

How to Modify Danelectro Pedals



The Dano Pedals are a bit different, so I'll detail a few differences in getting them open here. Mainly, the main difference is that you'll need to take the knobs off, and the removal of the circuitboard (shown here over the next few pages).



First, unscrew the back screws, and all the screws in the circuitboard. Put in a safe place. Pull the knobs off of the front. If you use pliers, be careful—they can scratch the knobs if they move around on the plastic.

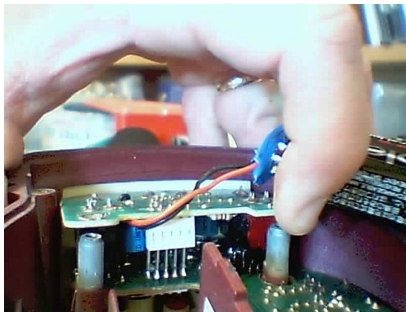

Next, gently pull the first, smaller circuit board off of the pins

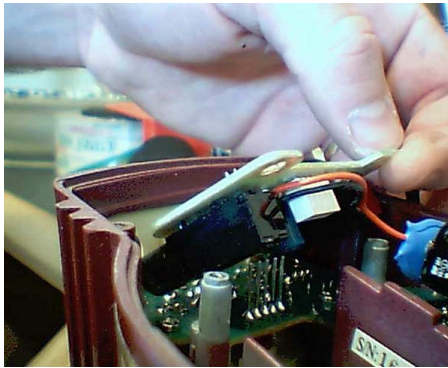

At the same time, pull the board in the direction opposite of the jacks.

Push gently on the knobs to pull the 2nd circuitboard out.



Now, follow the same directions and procedures as you would with any other guitar pedal, as detailed in the previous chapters.

When re-assembling, reverse directions.

When installing 2nd circuitboard, gently push the pins out with your finger, and insert the jacks first, then set the circuit board down on the pins.

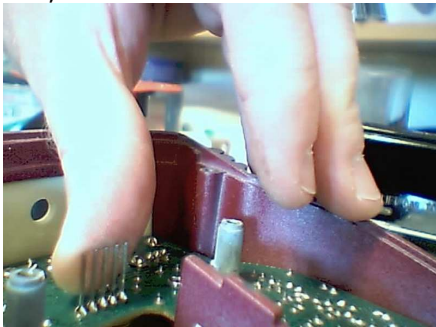

How to read the parts list for each modification.

How to read the parts list

Pedal Mod

Location	Mod value	
C1	.1 uf	
C2	.1 uf	
C3	.1 uf	
C6	<u>remove</u>	
D6	Germanium	
D5	1n4001	
D4	<u>led</u>	
Blue led		



These are the parts you need.

Note: c= capacitor, d= diode, r = resistor (under location) voltages do not matter. The smaller the voltage, the smaller the size of the component.

Notice the circuit board location.

If it starts with a C, it is a cap.

If it starts with an R, it is a resistor

If it starts with a D, it is a diode

If it starts with a Q, it is a transistor

Also, uf/mf, nf, and pf are all values of capacitors.

Uf is pronounced microfarad, which is why some write mf. Nf is pronounced Ninofarad, pf is pronounced picofarad.

Where To Buy Parts

You can always get parts kits from us at Guitartone.net – our kits are specially laid out in such a way to make it very easy, and eliminates the hassle of combing the various electronic parts manufacturer's websites searching through tons and tons of spec sheets looking for the special part you need.

For example here is how our parts kits look when you get them:

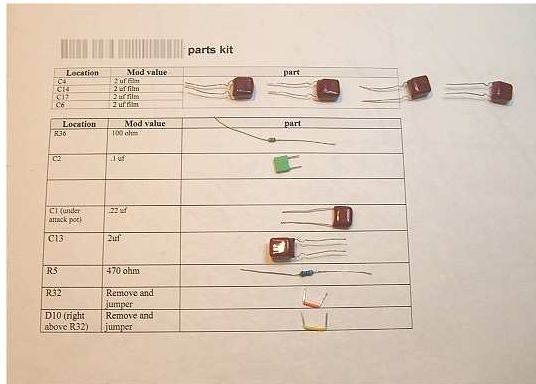

However, there are a number of other places to get parts. Most notably:

www.digikey.com

www.mouser.com

www.diyStompBoxes.com/cart/ -- Aron Nelsons WONDERFUL website – the Pinnacle of the DIY world! Aron has excellent 3pdt switches, transistors, vero board, diodes (including the hard to find germanium diodes).

www.smallbearelec.com

Super great company to do business with! The owner is a stompbox guru himself, and even has several kits you can build. He caters to the stompbox builders and generally has everything you would ever need. Easier to navigate than digikey and mouser as well.

Also, Radio Shack has comparable parts, but they are a bit more expensive.

If you go to Radio Shack or a local electronic parts supply, any film cap will work, as long as it is 16 volts or LARGER. Same with Resistors, and any/all other parts. I do not recommend using the 1uF film capacitors from there, though – they are huge!

Led's can be nearly any type, get 'superbright' or 'ultrabright' led's for on/off light, however (minimum: 1000 mcd rating).

Most importantly for any part is tolerance – the closer the tolerance, the more the pedal will sound like it is intended to. This is the main difference between poly film and metal film caps – the tolerance is usually closer on metal film, though sometimes they might sound a little bit different, even the same values. Metal film sound a little more 'high end' to me – a bit cleaner. Small Bear Electronics

For an easy way to purchase from Small Bear, go to <http://www.guitartone.net/smallbear.htm>

SMALL BEAR ELECTRIC PARTS LIST (highly recommended for stompbox builders!)	
Part Description	Link to purchase part
Resistors	http://www.smallbearelec.com/Search.bok?category=Resistors
Capacitors	http://www.smallbearelec.com/Search.bok?category=Capacitors%2C+Low+Voltage+Poly+Film
IC chips	http://www.smallbearelec.com/Search.bok?category=ICs+-+Op-Amps+and+Linear
Diodes	http://www.smallbearelec.com/Search.bok?category=Diodes+and+Rectifiers
Switches	http://www.smallbearelec.com/Search.bok?category=Switches
True bypass switches (3pdt)	http://www.diystompboxes.com/pedals/index2.html -- HIGHLY RECOMMENDED!
Wire	http://www.smallbearelec.com/Detail.bok?no=85

DIGIKEY

DIGIKEY PRODUCTS www.digikey.com	Digikey Part Number
Caps	
47pF Silver Mica CAPACITOR	338-1084-ND
200 pf ceramic cap CAPACITOR	1375PH-ND
220pF Silver Mica CAPACITOR	338-1046-ND
470pF Silver Mica CAPACITOR	338-1043-ND
.01 uF / .012 uF CAPACITOR	P4514-ND
.01 uf metal film CAPACITOR	P4513-ND OR P4514-ND
.022 uf metal film CAPACITOR	P4517-ND OR P4518-ND
.033 uf metal film CAPACITOR	P4519-ND
0.047µF Metal Film CAPACITOR	P4521-ND
.056uF Metal film CAPACITOR	P4522-ND
0.1µF Metal Film CAPACITOR	P4525-ND
.15 uF metal film CAPACITOR	P4538-ND
.22uF metal film CAPACITOR	P4667-ND
.47uf metal film cap CAPACITOR	P4544-ND
1µF Metal Film CAPACITOR	P4675-ND

For more digikey caps: <http://dkc3.digikey.com/PDF/T051/0931.pdf>

Any voltage is fine -- the smaller the voltage, the smaller the part, which is easier to fit in a pedal.

There will be no difference in sound.

More Part numbers for digikey capacitors

Working Voltage	Cap. μ F	Digi-Key Part No.	10
			Bulk Pack
50	0.01	P4513-ND*	.95
	0.012	P4514-ND	1.35
	0.015	P4515-ND*	1.27
	0.018	P4516-ND	1.44
	0.022	P4517-ND*	1.47
	0.027	P4518-ND*	1.53
	0.033	P4519-ND*	1.59
	0.039	P4520-ND	1.59
	0.047	P4521-ND*	1.41
	0.056	P4522-ND	1.44
	0.068	P4523-ND*	1.47
	0.082	P4524-ND*	1.50
	0.1	P4525-ND*	1.80
	0.12	P4526-ND	1.98
	0.15	P4538-ND	2.07
	0.15	P4665-ND*	2.07
	0.18	P4666-ND*	2.10
	0.22	P4667-ND	2.10
	0.27	P4668-ND*	2.25
	0.33	P4669-ND*	2.37
	0.39	P4670-ND	2.58
	0.47	P4671-ND*	3.30
	0.56	P4672-ND*	3.39
0.68	P4673-ND*	5.10	
0.82	P4674-ND*	5.10	
1.0	P4675-ND*	4.22	

Other DIGIKEY PRODUCTS www.digikey.com	Digikey Part Number
3mm White Super Bright LED	67-1606-ND
ALUM BOX 7.6 X 4.4 X 2.2"	HM843-ND
ALUM BOX - 4 3/4" WIDE X 3 3/4" TALL X 1 1/8" TALL	HM152-ND
1n4148 diode	1N4148MSCT-ND
1n4001 diode 1n4002, 1n4003, 1n4004, etc. will all work the same. There is no 1n5001, it is a typo in a few of the diy kits.	1N4001GICT-ND
10' desolder braid	EB1097-ND
generic 3mm red clipping led (LED'S used in place of diode)	P363-ND
ultrabright 5mm red led	CMD3750-ND
ultrabright 5mm green led	CMD3450-ND
TL072 IC chip (op amp)	296-1282-5-ND

Digikey 1% tolerance metal film resistors	Part Number
100 ohm 1% Metal Film Resistor	P100CACT-ND
470 ohm 1% Metal Film Resistor	P470CACT-ND
1K, 1% Metal Film Resistor	P1.00KCACT-ND
2.2k 1% Metal Film Resistor	P2.20KCACT-ND
3.3k 1% Metal Film Resistor	P3.30KCACT-ND
4.7k 1% Metal Film Resistor	P4.70KCACT-ND
10k 1% Metal Film Resistor	P10.0KCACT-ND
22k 1% Metal Film Resistor	P22.0KCACT-ND
47k 1% Metal Film Resistor	P47.0KCACT-ND
100k 1% Metal Film Resistor	P100KCACT-ND
220k 1% Metal Film Resistor	P220KCACT-ND
470k 1% Metal Film Resistor	P470KCACT-ND

MOUSER

MOUSER PRODUCTS	<u>WWW.MOUSER.COM</u> PART NUMBER
GENERIC CLIPPING LEDS	638-204HD
BOSS STYLE POWER JACKS	163-4302
1n34a Germanium diodes (will work for 1n270 diodes as well)	526-1N34A
Neutrik 1/4" Jacks	568-NYS234-3
0.1uF caps	MKT1817410064
0.15uF caps	MKT1826415064
SPDT Miniature toggle switch	108-1ms1t1b1m1qe
DPDT Miniature toggle switch	108-1md1t1b1m1qe
.001uf ceramic cap	75-1c25x7r102k050b
1n4001 diodes	821-1n4001

1n34a Germanium diodes: <http://www.web-tronics.com/1n34.html>

Modification Details for each pedal



Boss ™, Ibanez ™, MXR ™, Fulltone ™, Visual Sound ™, Tubeworks ™, Tonebone ™, Danelectro ™, Voodoo Labs ™, Vox ™, Hughes & Kettner ™, Electro Harmonix ™, DOD ™, Dunlop ™, Morley ™, Crybaby ™, Marshall ™, Proco Rat ™, Arion ™, Nobels ™, Mesa Boogie ™, Bogner ™, and any other company mentioned here are used respective of their trademark.

Notes: Unless specified, assume all capacitors will be film capacitors. I prefer the metal film caps from Digikey.com (see <http://www.guitartone.net/buyparts.htm>). Also, for clipping LED's, I use generic 3mm red ones, though it doesn't matter. It won't make a difference in tone generally. As far as the changes I'm making, the following 'DIY mods' are simply guidelines and suggestions from my experiments. They are made to allow YOU to experiment with what will work best for your needs.

I have tried to post a schematic whenever possible, and have gotten permission from everyone who owned the copyright of the particular schematic, unless no contact information was given. In this instance, I have simply put 'found on web' on it, if you know of the person who needs to be given credit for it, please contact me and full credit will be given. :)

VERY IMPORTANT NOTE! TO BE NOTIFIED OF UPDATES TO THESE MODIFICATIONS, PLEASE EMAIL diy-kit-updates@getresponse.com and you will be put on a mailing list to receive the updates. You will receive an automatic reply – if you don't, your email is filtering it and marking it as 'spam' or junk mail.

To purchase new pedals (to modify) at the lowest prices, go to www.guitartone.net/mf.htm

Arion Tubulator

"BSM (Brent Mason) MOD"

Location	Mod value
A	1K RESISTOR
B	.47 Capacitor
C	10K RES
D	1N4001
E	1n4001 + 1n4001 SERIES
F (2 OF THEM)	1 UF FILM CAPS
G	.15 uf cap

"316 MOD"

Location	Mod value
A	1K RESISTOR
B	.22UF
C	10K RESISTOR
D	LED
E	LED + 1n4148 in SERIES
F (2 OF THEM)	1 UF FILM CAPS

Modification similar to a boutique overdrive *

Location	Mod Value
C	22k
G	.15uf
B	.1uf
D,E	1n4148 + 1n4148 diodes connected in series, one set of these connected diodes will replace one stock diode.
A	3.3k
Tone pot	Connect a 10k resistor on lug 1 and lug 3 of the tone pot.

***any LED will work about the same when used as a clipping diode.**

***This mod only reflects a similar sound to a popular overdrive popularized by many avid overdrive pedal fans**

Note: The Arion Tubulator is nearly identical to the tubescreamer circuitry.

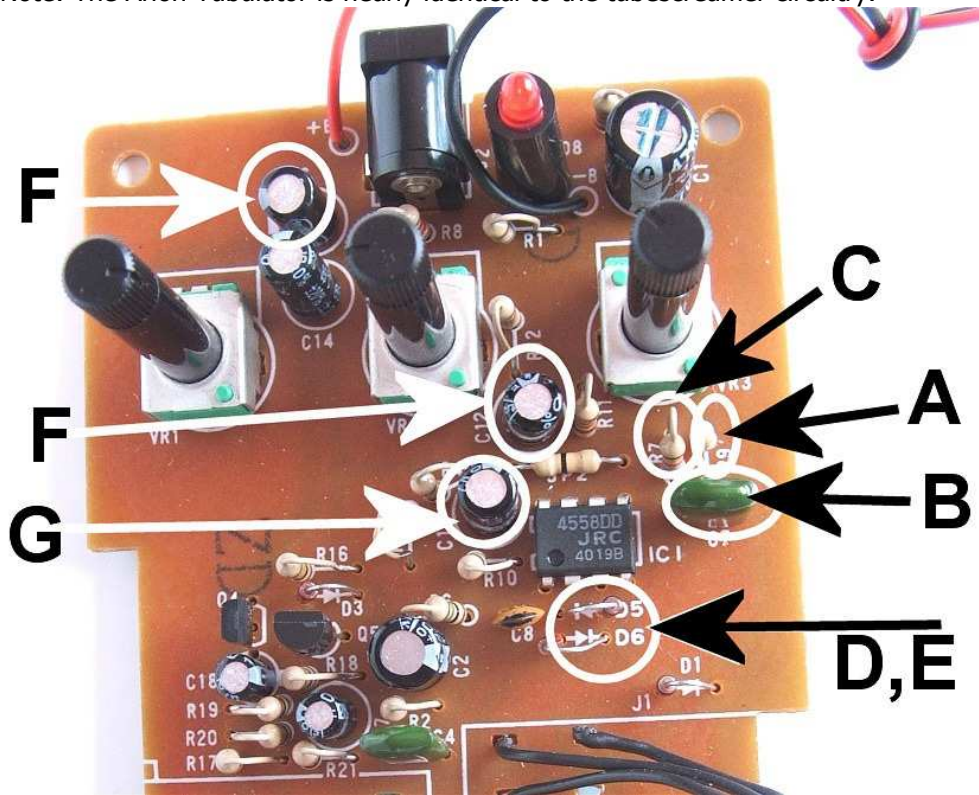

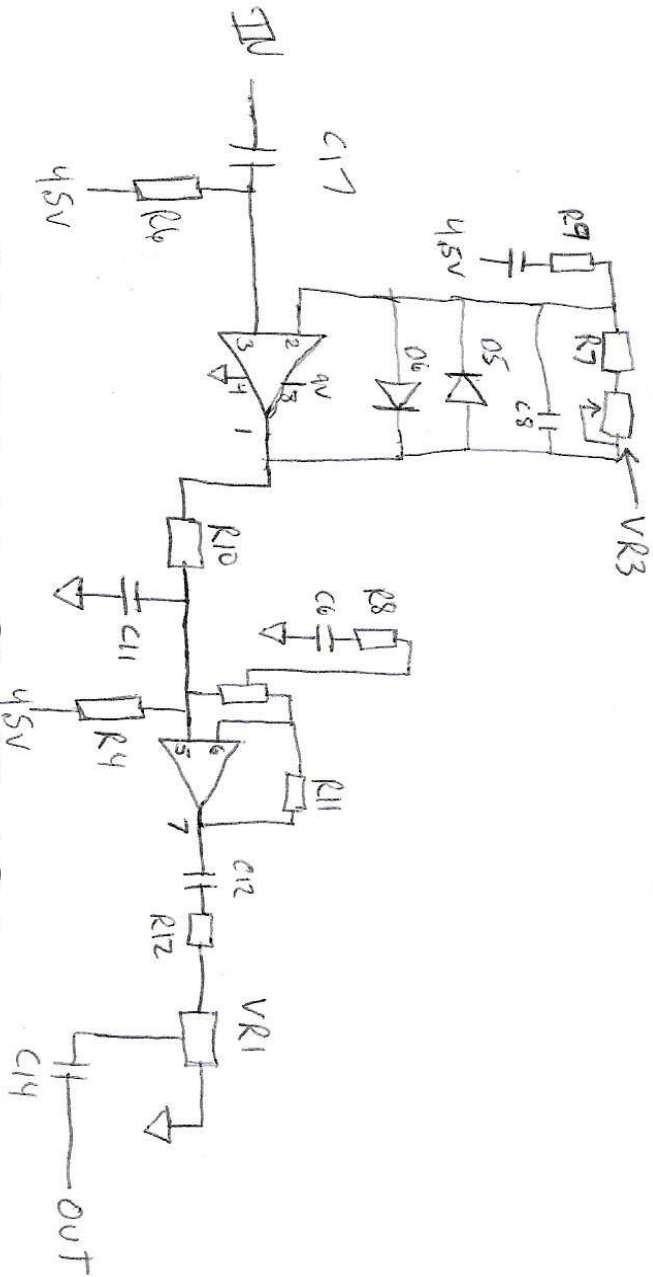

Arion Tubulator Simplified Schem
(C) 2006 Brian Wampler, Indyguitarist.com

ARION MDI-2 BASS DISTORTION

Location	Stock value	Mod value	What it effects
C6	.003	.01	LOWERS HIGHS, AND SMOOTHENS DISTORTION
D3	4148	Germanium-led in parallel	Adds lows, creates smoothness to tone. Also makes it much fuller.



BD-2 BLUES DRIVER

Full Body mod	
Location	Change to
C14	.22uF
C8	.1uF
C17	.1uF
C19	.1uF
C18	.01uF
C9	REMOVE, NO JUMPER
D8	LED
D10	LED
D9	JUMPER
C100	.1uF
C10	.1uF
C35	.047uF
C34	.1uF
C27	.0022uF
C10	1uF
C7	1uF

Tube mod	
Location	Change to
C14	.1uF
C17	.01uF
C19	.047uF
C8	.22uF
C100	.1uF
D9	LED
D10	1N34A (germanium)
C10	.1uF
C35	.047uF
C34	.1uF
C27	.0022uF
C10	1uF
C7	1uF

Hot Rod mod	
Location	Change to
C14	.1uF
C17	.01uF
C19	.0047uF
C8	.22uF
C9	REMOVE (no jumper)
C100	.047uF
D10	LED
C10	.1uF
C35	.047uF
C34	.1uF
C27	.0022uF
C10	1uF
C7	1uF

Brent Mason mod	
C14	.1uF
C17	.01uF
C19	.01uF
C100	.22uF
D9	LED AND .001uF CAP IN PARALLEL D10(SEE IMAGE ON NEXT PAGES)
D10	LED
D3	LED
C10	.1uF
C35	.047uF
C34	.1uF
C27	.0022uF
C10	1uF
C7	1uF