

REVISIONS F (180401)

DRAWN BHK

CHECKED

DATE 04.04. 2  
13:39



PROJECT  
ACX1000  
ULTRACOUSTIC  
INSTRUMENT CHANNEL  
SHEET 1 OF 5 SHEETS TOTAL

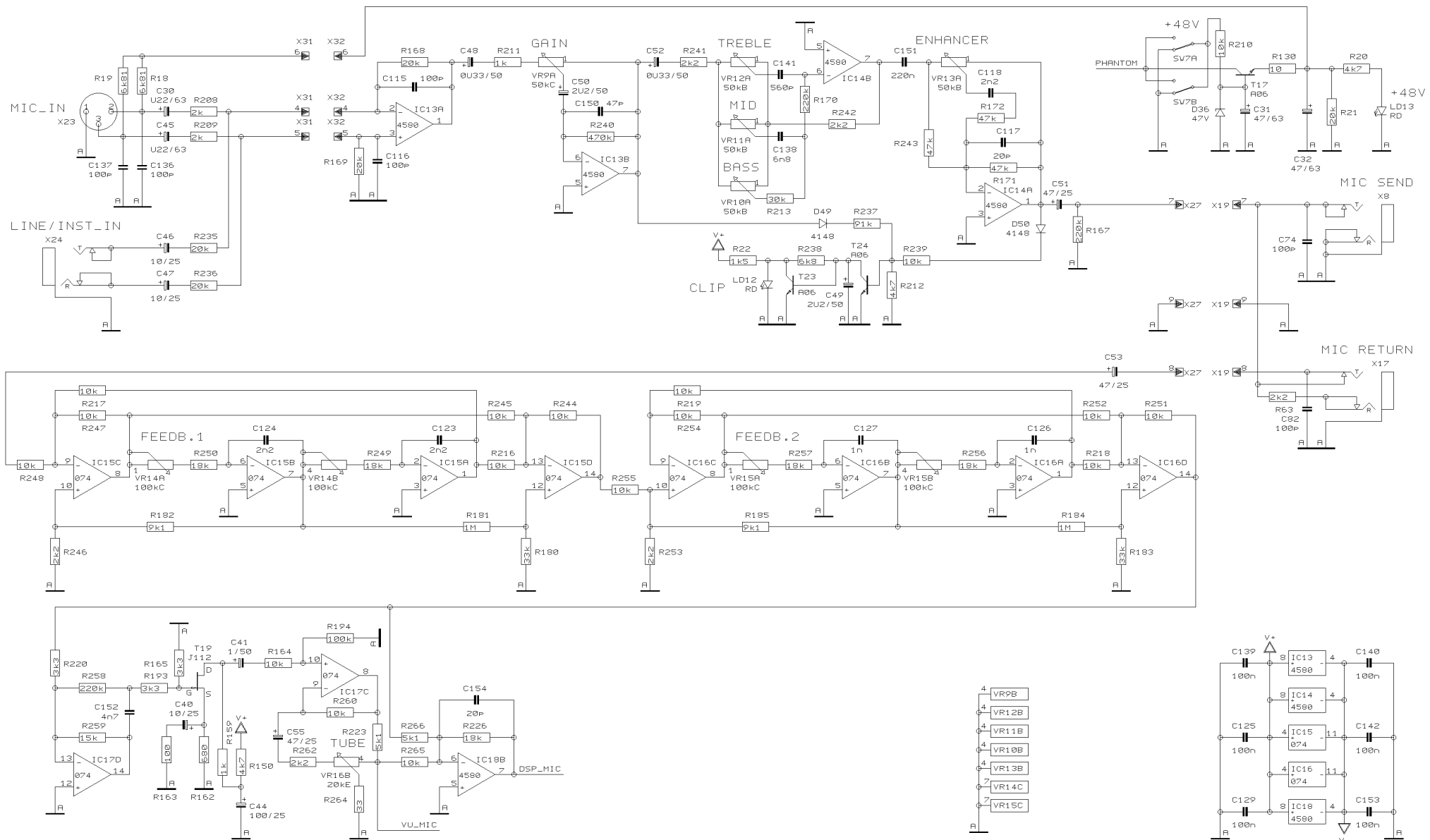

REVISIONS F

DRAWN BHK

CHECKED

DATE 04.04. 2  
13:39



PROJECT  
ACX1000  
ULTRACOUSTIC  
MIC CHANNEL  
SHEET 2 OF 5 SHEETS TOTAL

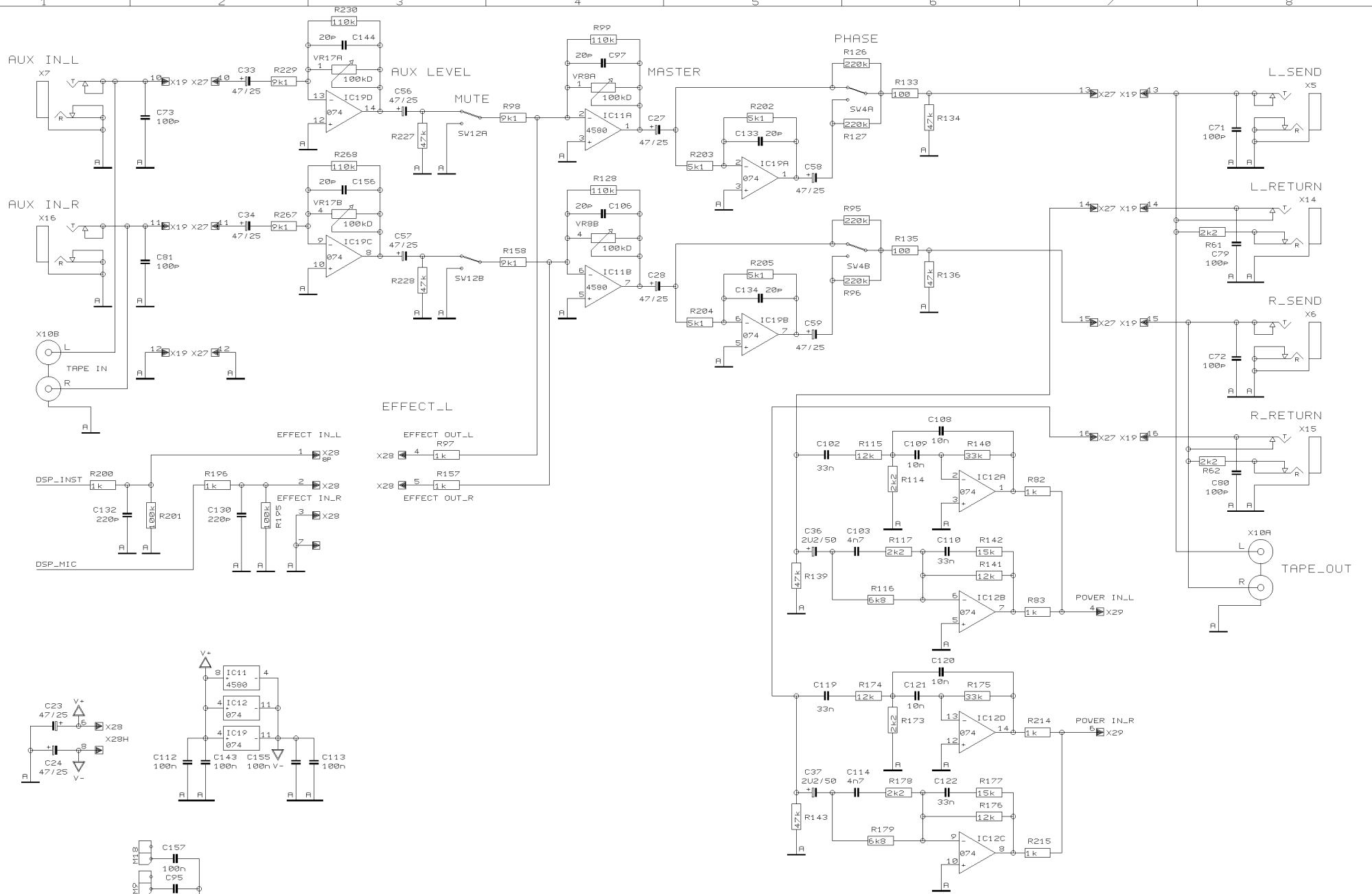

REVISIONS F

DRAWN BHK

CHECKED

DATE 04.04. 2  
13:40



PROJECT  
ACX1000  
ULTRACOUSTIC  
MASTER SECTION  
SHEET 3 OF 5 SHEETS TOTAL

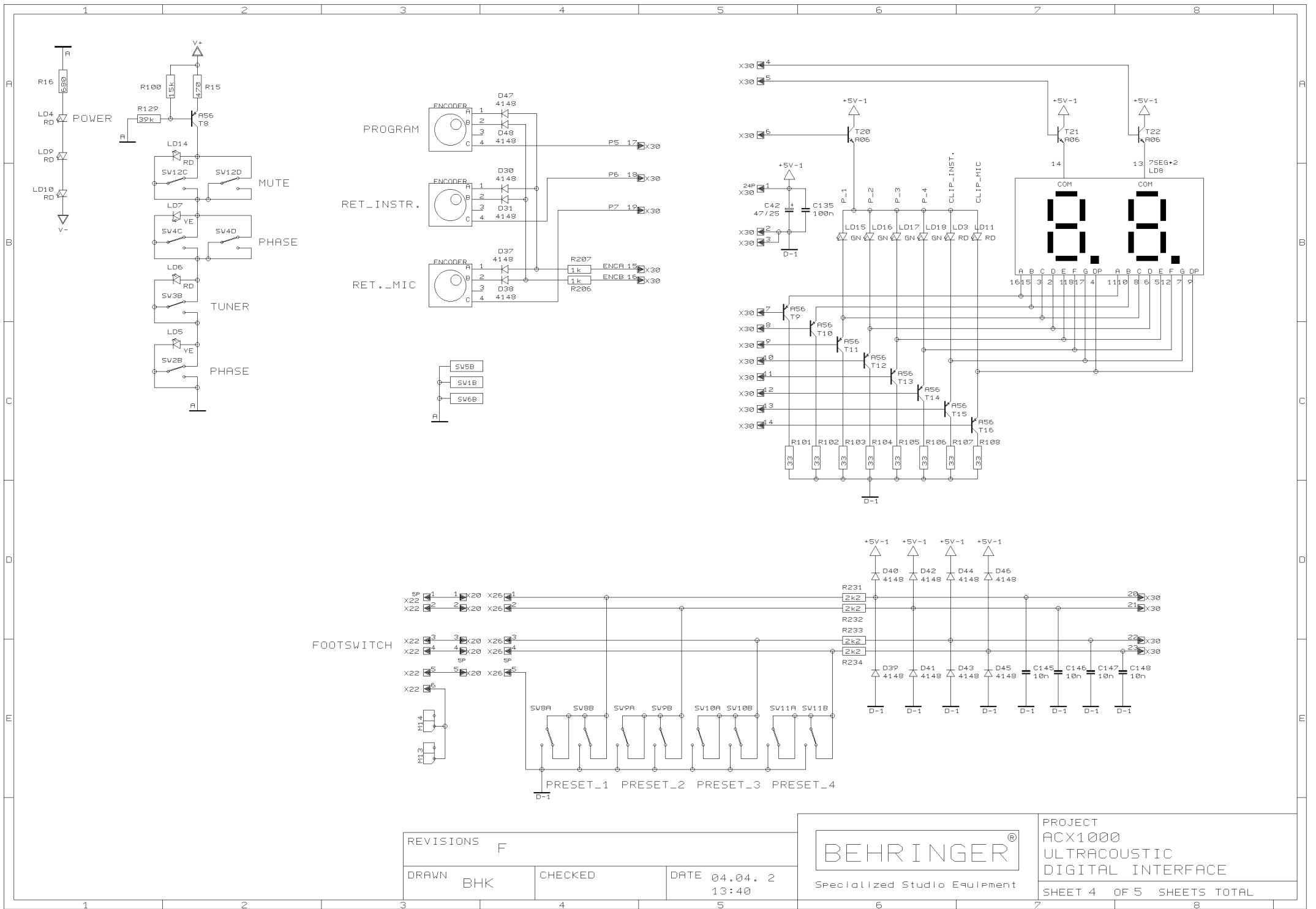

REVISIONS		F	
DRAWN	BHK	CHECKED	DATE 04.04. 2 13:40



PROJECT  
ACX1000  
ULTRACOUSTIC  
DIGITAL INTERFACE  
SHEET 4 OF 5 SHEETS TOTAL

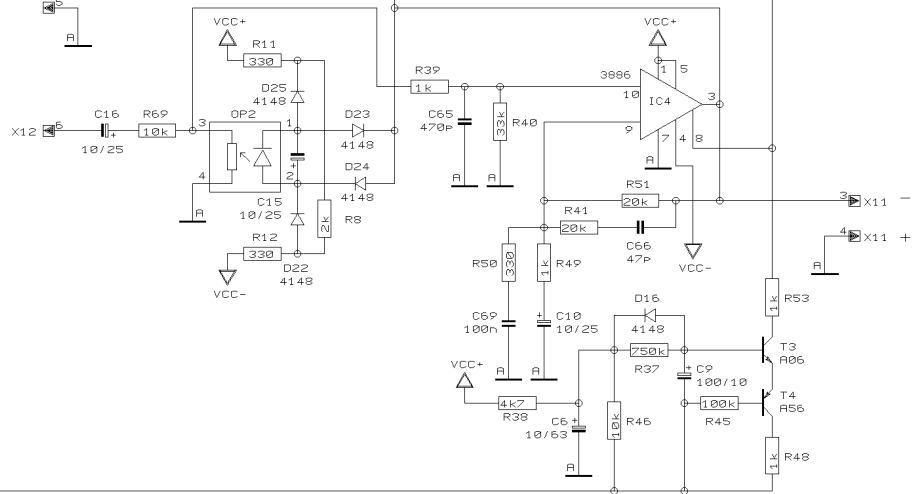
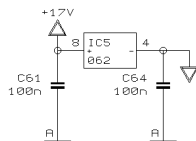
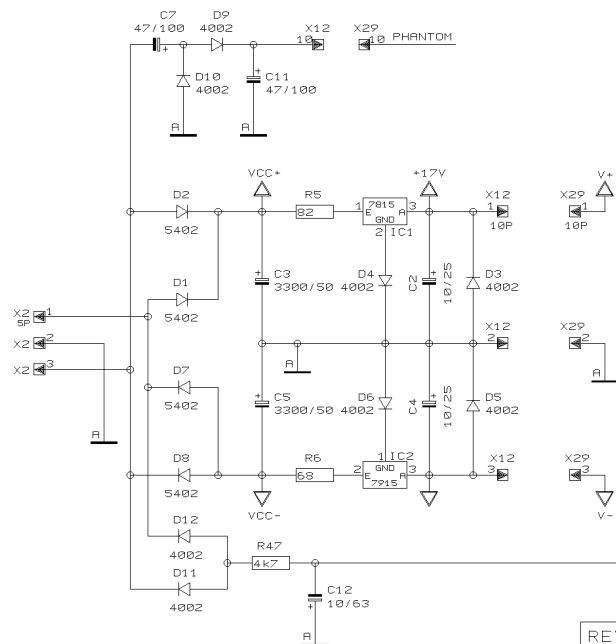
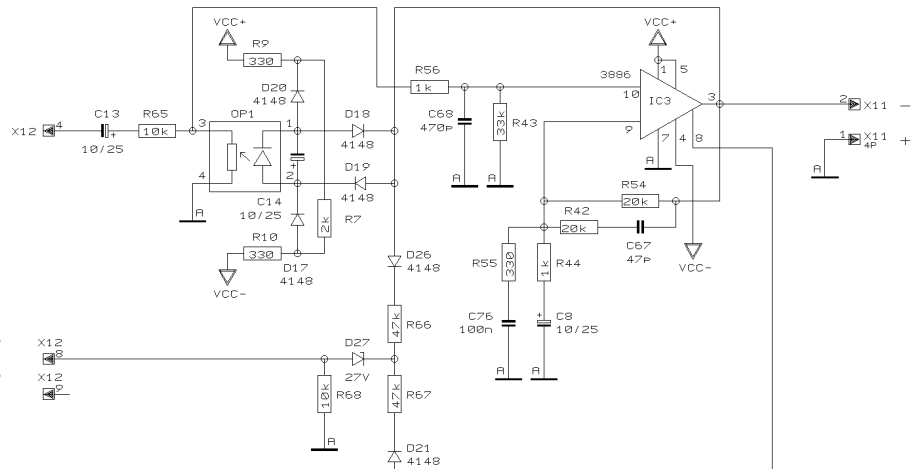
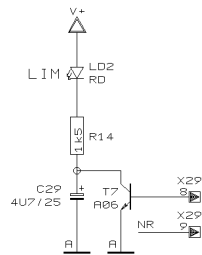
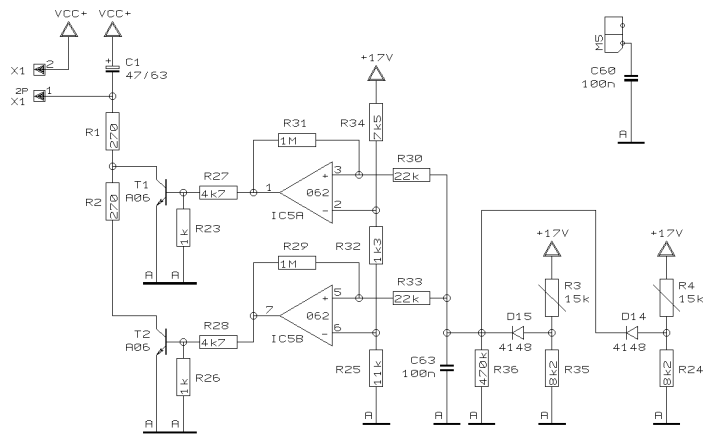

REVISIONS		F
DRAWN	BHK	CHECKED
DATE		04.04. 2
		13:41



PROJECT  
ACX1000  
ULTRACOUSTIC  
POWER AMPLIFIER & PSU  
SHEET 5 OF 5 SHEETS TOTAL